

Radeon R5xx Acceleration

Trademarks

AMD, the AMD Arrow logo, Athlon, and combinations thereof, ATI, ATI logo, Radeon, and Crossfire are trademarks of Advanced Micro Devices, Inc.

Microsoft and Windows are registered trademarks of Microsoft Corporation.

Other product names used in this publication are for identification purposes only and may be trademarks of their respective companies.

Disclaimer

The contents of this document are provided in connection with Advanced Micro Devices, Inc. ("AMD") products. AMD makes no representations or warranties with respect to the accuracy or completeness of the contents of this publication and reserves the right to make changes to specifications and product descriptions at any time without notice. No license, whether express, implied, arising by estoppel, or otherwise, to any intellectual property rights are granted by this publication. Except as set forth in AMD's Standard Terms and Conditions of Sale, AMD assumes no liability whatsoever, and disclaims any express or implied warranty, relating to its products including, but not limited to, the implied warranty of merchantability, fitness for a particular purpose, or infringement of any intellectual property right. AMD's products are not designed, intended, authorized or warranted for use as components in systems intended for surgical implant into the body, or in other applications intended to support or sustain life, or in any other application in which the failure of AMD's product could create a situation where personal injury, death, or severe property or environmental damage may occur. AMD reserves the right to discontinue or make changes to its products at any time without notice.

© 2008 Advanced Micro Devices, Inc. All rights reserved.

1. INTRODUCTION	6
1.1 INTRODUCING THE R5XX FAMILY	6
1.2 FEATURE HIGHLIGHTS	6
1.3 FEATURES IN DETAIL	6
1.4 CHANGES FROM R3XX/4XX	7
2. TILING.....	9
2.1 OVERVIEW	9
2.2 MICRO BLOCKS.....	9
2.3 MACRO BLOCKS	9
3. SURFACE FORMATS	11
4. COMMAND PROCESSOR	13
4.1 OVERVIEW	13
4.2 HOST PROGRAMMING MODEL DESCRIPTION	13
4.3 PUSH VS PULL MODEL	13
4.4 RING BUFFER MANAGEMENT	14
4.5 CHIPSET COHERENCY ISSUES.....	16
4.6 INDIRECT BUFFER MANAGEMENT.....	16
4.7 OVERVIEW OF DMA OPERATION	17
4.8 RESETTING THE COMMAND PROCESSOR	19
4.9 COMMAND STREAM SYNCHRONIZATION.....	19
4.10 STARTING THE INDIRECT STREAMS.....	20
4.11 WRITING HOST DATA TO THE COMMAND STREAM QUEUE	21
4.12 WRITING TO THE MICROENGINE RAM	22
4.13 READING FROM THE MICROENGINE RAM	22
4.14 STARTING A DMA OPERATION	23
5. PM4.....	24
5.1 PACKET TYPES	24
5.2 DEFINITION OF TYPE-3 PACKETS.....	28
6. VERTEX SHADERS	54
6.1 INTRODUCTION.....	54
6.2 INPUT	54
6.3 VECTOR ORDER AND VECTOR ID'S.....	59
6.4 VAP REGISTERS.....	60
6.5 R3XX-R5XX PROGRAMMABLE VERTEX SHADER DESCRIPTION	66
7. FRAGMENT SHADERS	94
7.1 INTRODUCTION.....	94
7.2 INSTRUCTIONS.....	94

7.3	INSTRUCTION WORDS	95
7.4	ALU INSTRUCTIONS.....	96
7.5	TEXTURE INSTRUCTIONS	104
7.6	FLOW CONTROL.....	106
7.7	FLOATING POINT ISSUES	112
7.8	WRITING TO US REGISTERS.....	115
8.	HIZ.....	117
8.1	INTRODUCTION	117
8.2	ENABLING HIZ.....	117
8.3	CONFIGURING HIZ	117
8.4	HIZ CLEAR WITH PM4 PACKET	119
8.5	EXAMPLE: PUTTING IT ALL TOGETHER	119
8.6	STATE CHANGES THAT INVALIDATE HIZ	120
9.	DRIVER NOTES.....	121
9.1	R5XX CHANGES	121
9.2	INTERFACE NOTES	123
9.3	REGISTER NOTES.....	124
9.4	FEATURE NOTES	129
9.5	BLEND OPTIMIZATION NOTES.....	132
9.6	TEXTURE NOTES.....	132
9.7	ERRATA.....	133
10.	REGISTERS.....	134
10.1	COLOR BUFFER REGISTERS	134
10.2	FOG REGISTERS.....	150
10.3	GEOMETRY ASSEMBLY REGISTERS	153
10.4	GRAPHICS BACKEND REGISTERS	164
10.5	RASTERIZER REGISTERS.....	173
10.6	CLIPPING REGISTERS	176
10.7	SETUP UNIT REGISTERS	184
10.8	TEXTURE REGISTERS.....	192
10.9	FRAGMENT SHADER REGISTERS.....	203
10.10	VERTEX REGISTERS.....	228
10.11	Z BUFFER REGISTERS	253

1. Introduction

1.1 Introducing the R5xx Family

The R5xx family provides the fastest and most advanced 2D, 3D, and multimedia graphics performance for desktop PCs in the performance mainstream markets. The R5xx family supports Shader Model 3.0, advanced memory interface technology, a brand new display controller and a consumer electronics (CE) quality TV (NTSC/PAL) encoder. The R5xx family represents AMD's 2nd generation PCI Express technology product and leverages a brand new graphics architecture. The R5xx family builds on the R3xx architecture. As such, much of this guide is applicable to R3xx and R4xx chips as well with some caveats. Where applicable, generational differences are noted.

1.2 Feature Highlights

1.2.1 Shader Technology

- Support for Microsoft® DirectX® 9.0 programmable vertex and pixel shaders in hardware.
- Shader Model 3.0 vertex and pixel shader support.
- Full speed 32-bit floating point processing.
- High dynamic range rendering with floating point blending and anti-aliasing support.
- High performance dynamic branching and flow control.
- Complete feature set also supported in OpenGL® 2.0.

1.2.2 Anti-Aliasing

- 2x/4x/6x Anti-Aliasing modes.
- Sparse multi-sample algorithm with gamma correction, programmable sample patterns, and centroid sampling.
- New Adaptive Anti-Aliasing mode.
- Temporal Anti-Aliasing.
- Lossless Color Compression (up to 6:1) at all resolutions, up to and including widescreen HDTV.

1.2.3 New Ring Bus Memory Controller

- Programmable arbitration logic maximizes memory efficiency, software upgradeable.
- New fully associative texture, color, and Z cache design.
- Hierarchical Z-Buffer with Early Z Test.
- Lossless Z-Buffer Compression (up to 48:1).
- Fast Z-Buffer Clear.
- Z Cache optimized for real-time shadow rendering.
- Optimized for performance at high display resolutions, up to and including widescreen HDTV.

1.3 Features in Detail

1.3.1 2D Acceleration Features

- A highly optimized 128-bit engine, capable of processing multiple pixels/clock.

- Hardware acceleration provided for BitBLT, line drawing, polygon and rectangle fills, bit masking, monochrome expansion, panning and scrolling, scissoring, and full ROP support (including ROP3).
- Optimized handling of fonts and text using ATI proprietary techniques.
- Game acceleration including support for Microsoft's DirectDraw: Double Buffering, Virtual Sprites, Transparent BLT, and Masked BLT.
- Acceleration in 8/15/16/32-bpp modes.
- Support for WIN 2000 & WIN XP GDI extensions: Alpha BLT, Transparent BLT, Gradient Fill.
- Hardware cursor support up to 64x64x32-bpp, with alpha channel for direct support of WIN 2000 & WIN XP alpha cursor standard.

1.3.2 3D Acceleration Features

- Fully DirectX 9.0 compliant, including full speed 32-bit floating point per component operations.
- Shader Model 3.0 support with programmable vertex shaders (full operand and operation support) allowing up to 1024 instructions and 256 vectors of constant store. This includes vertex shader loops, branches, and subroutines, which allow support of the following:
 - 1024 vertex shader instruction store.
 - 261,888 instructions with a single loop.
 - 4+ trillion instructions with nested loops.
 - Dynamic flow control.
 - 8 full vertex processing units.
- Advanced pixel shaders with the following features:
 - New advanced shader design, with ultra-threading sequencer for high efficiency operations.
 - Full Pixel Shader 3.0 support.
 - Advanced, high performance branching support.
 - 32-bit floating point support for high dynamic range computations.
- Full anti-aliasing on render surfaces up to and including 64-bit floating point formats.
- Support for 2xAA, 4xAA and 6xAA subsamples, with little performance loss in most cases.
- Advanced AA quality algorithms, generating visuals that are superior to other solutions with an equivalent number of samples.
- New adaptive anti-aliasing modes dynamically select between fast multi-sampling and high quality super-sampling per polygon, delivering the benefits of both techniques.

1.4 Changes from R3xx/4xx

Changes from R3xx to R4xx

- Support for 1, 2, 3 and 4 quad pixel pipes
- Support for 1 to 6 vertex shader pipes
- HDTV resolution support for HiZ
- Support of 16x16 and 32x32 pixel tile sizes (32x32 should now be the preferred amount)
- Vastly redesigned Memory controller, with new client interfaces
- Support for 8b of subpixel precision
- Native support of 4Kx4K raster target
- PS instruction support now at 512 each for Scalar, Vec3 and Texture (1536 total instructions)
- VS native support for Sin/Cos
- TX Component swizzling
- Enhanced texture performance
- MRT and wide pixel performance fixes

- Fog alpha rounding matches RGB
- Line stipple fixes; SU texture stuffing improvements
- LOD Clamp/bias re-order
- 2D support for larger pixels (Pitch at 16b)
- 4x AA buffer tiling is changed when memory mapping is not used

Changes from R4xx to R5xx

- New Memory controller
- Support of VS3.0 features, except Vertex fetch
- Support of all PS3.0 features, including extended GPRs and Constants, all branching and predication
- New FP32 US, including most IEEE NaNs, INFs behavior corrected (still TRUNC rounding mode)
- Support of new Z range [-2,2], with per pixel clamping in SC
- Support of up to 11 texture sets (10 explicit), or 44 iterators
- Support of color to texture mappings, and texture to color mappings (for performance improvements)
- New IS_IP for better mapping of components from VS to PS
- Color now in FP20 mode, instead of S3.12 mode
- New HiZ compression mode, allows high precision Z values to be stored
- New FP16 render surfaces support, including blending and all backend functions, but not texture filtering
- Fully set associative caches for Texture, Color, and Z
- New more efficient fifos for all MC clients
- New Filter4 mode for Texture unit
- New 1b texture mode for texture unit

2. Tiling

2.1 Overview

R3xx-R5xx support two types of blocks

- Micro block
- Macro block

Each block type can either be linear or tiled.

2.2 Micro Blocks

A micro block refers to a 32-byte consecutive data in memory. It is aligned to a 32-byte boundary, which means that the 5 LSBs of a micro-block address are zeros. Micro blocks can be linear or tiled. Linear maps a 1D area of an image to the block. Tiled maps a 2D area of an image to a block. The following table shows the different type of micro blocks and the region of the 2D image that maps to it (x X y)

	Micro-linear	Micro-tiled
8 bit pixel	32x1 pixels (x=32 , y=1)	8x4 pixels (x=8 , y=4) supported by : tx/cb/hdp
16 bit pixel	16x1 pixels (x=16 , y=1)	4x4 pixels (x=4 , y=4) supported by : tx/cb/zb/hdp
16 bit pixel	16x1 pixels (x=16 , y=1)	8x2 pixels (x=8 , y= 2) supported by: tx/cb/hdp/disp
32 bit pixel	8x1 pixels (x=8 , y=1)	4x2 pixels (x=4 , y=2) supported by: tx/cb/zb/hdp/disp
64 bit pixel	4x1 pixels (x=4 , y=1)	2x2 pixels (x=2 , y=2) supported by: tx/hdp
128 bit pixel	2x1 pixels (x=2, y=1)	

2.3 Macro blocks

A macro block refers to a 2K-byte consecutive data in memory. Macro-blocks loosely refer to the size a DRAM page. How micro tiles are arranged in a macro-tile is controlled by whether the macro-block is linear or tiled. Linear macro block maps x-order sequential array of micro-blocks to a macro-block. When the end of the current scan is reached, the macro-block continues with data from the next micro-tile in the next scan. The alignment for Linear macro-blocks is 32 bytes. An image can generally be more compact using macro-linear, but it is typically slower in rendering performance. Tiled macro-blocks map a 2D region of micro-blocks into a macro-block. Tiled macro-blocks are aligned to a 2K-byte boundary, which means that the 11 LSBs of a macro-block address are zeros

There are 64 micro-blocks in a macro-block (2k divided by 32 bytes). In a tiled macro-block these 64 micro-blocks are arranged as an 8x8. The number of pixels in x and y that map into a tiled macro-block is based on pixel size and micro-block type. Multiplying the data from the previous table by 8 can do this:

	Macro-tiled Micro-linear	Macro-tiled Micro-tiled
8 bit pixel	256x8	64x32
16 bit pixel (8x2)	128x8	64x16
16 bit pixel (4x4)	128x8	32x32
32 bit pixel	64x8	32x16
64 bit pixel	32x8	16x16

3. Surface Formats

This section describes all of the surface formats used by the R3xx-R5xx texture units and frame buffers. These formats are first listed in summary, together with a list of features (fog, blend etc.) supported by each format.

8-bit Formats

Format	Layout	Range	Display	Blend	Fog	Dither	Filter
C_8		0.0 to 1.0 (unsigned) -1.0 to +1.0 (signed)	Yes	Yes	No	Yes	Yes
C2_4		0.0 to 1.0	Yes	No	No	No	Yes
C_3_3_2		0.0 to 1.0	Yes	No	No	No	Yes

16-bit Formats

Format	Layout	Range	Display	Blend	Fog	Dither	Filter
C_16		0.0 to 1.0 (unsigned) -1.0 to +1.0 (signed)	No	No	No	No	Yes
C_16_MPEG		-1.0 to +1.0	No	No	No	No	Yes
C_16_FP		-2^{16} to $+2^{16}$	No	No	No	No	No
C2_8		0.0 to 1.0 (unsigned) -1.0 to +1.0 (signed)	Yes	Yes	No	Yes	Yes
C_5_6_5		0.0 to 1.0	Yes	Yes	Yes	Yes	Yes
C_6_5_5		0.0 to 1.0 (unsigned) -1.0 to +1.0 (signed)	No	No	No	No	Yes
C4_4		0.0 to 1.0	Yes	Yes	Yes	Yes	Yes
C_1_5_5_5		0.0 to 1.0	Yes	Yes	Yes	Yes	Yes

32-bit Formats

Format	Layout	Range	Display	Blend	Fog	Dither	Filter
C4_8		0.0 to 1.0 (unsigned) -1.0 to +1.0 (signed)	Yes	Yes	Yes	Yes	Yes
C4_8_GAMMA		0.0 to 1.0	Yes	Yes	Yes	Yes	Yes
C_11_11_10		0.0 to 1.0 (unsigned) -1.0 to +1.0 (signed)	No	No	No	No	Yes
C_10_11_11		0.0 to 1.0 (unsigned) -1.0 to +1.0 (signed)	No	No	No	No	Yes
C_2_10_10_10		0.0 to 1.0 (unsigned) -1.0 to +1.0 (signed)	Yes	No	No	No	Yes
C2_16		0.0 to 1.0 (unsigned) -1.0 to +1.0 (signed)	No	No	No	No	Yes
C2_16_MPEG		-1.0 to +1.0	No	No	No	No	Yes

C2_16_FP		-2^{16} to $+2^{16}$	No	No	No	No	No
C_32_FP		-2^{127} to $+2^{127}$	No	No	No	No	No
C_AVYU		0.0 to 1.0	Yes	Yes	Yes	Yes	Yes
C_VYUY		0.0 to 1.0	Yes	Yes	Yes	Yes	Yes
C_YVYU		0.0 to 1.0	Yes	Yes	Yes	Yes	Yes

64-bit Formats

Format	Layout	Range	Display	Blend	Fog	Dither	Filter
C4_16		0.0 to 1.0 (unsigned) -1.0 to +1.0 (signed)	No	No	No	No	Yes
C4_16_FP		-2^{16} to $+2^{16}$	No	No	No	No	No
C2_32_FP		-2^{127} to $+2^{127}$	No	No	No	No	No

128-bit Formats

Format	Layout	Range	Display	Blend	Fog	Dither	Filter
C4_32_FP		-2^{127} to $+2^{127}$	No	No	No	No	No

Depth Formats

Format	Layout	Range	Write	Read
W_24		0 to $2^{24}-1$	Yes	No
W_24_FP		-2^{63} to $+2^{63}$	Yes	Yes

4. Command Processor

4.1 Overview

The Command Processor is a programmable processor that is meant to provide some on-chip intelligence for a Graphics Controller device. The CP architecture has been approached as a special-purpose computing engine, targeted at fetching and interpreting a PROMO4 command stream.

The Command Processor takes on several tasks in a typical Graphics Controller:

- Acts as a receiver of command streams from the video and graphics device driver(s) running on the host CPU. These command streams are either read from system memory using bus-mastering on the PCI or AGP bus, or directly written to the CP from the host CPU using the PCI or AGP (fast-write) bus. Three streams are supported – one Ring Buffer and two Indirect Buffers.
- Parses and interprets a command stream, and writes the parsed data to internal “Feature” modules of the Graphics Controller device; for example, a 3D graphics processor, a 2D graphics processor, a Video Processor, or an MPEG Decoder. The data writes can be 32, 64, 96, or 128 bits per clock. The 64, 96, and 128 bit writes will occur for “Vector Write Mode”. Vector write mode is valid when the stream (PQ, IQ1, IQ2) is in Pull Mode. Push mode will only write DWORDs (i.e. Lower 32-bits of the 128-bit data bus will be valid with a DWORD_Enable = “0001”. The 64 and 96-bit writes will only occur while the alignment of the data is not on a 128-bit boundary.
- There are two general-purpose DMA engines inside the CP, one for GUI-related tasks, and one intended for Video Capture tasks. The DMA engines do byte alignment between the source and destination surfaces.

4.2 Host Programming Model Description

This section describes the manner in which the host CPU communicates with the graphics controller chip.

4.3 Push vs Pull Model

The *Push Model* is also referred to as Programmed I/O (PIO). In this model the host CPU is writing to the graphics controller chip across either the PCI or AGP bus. That is, the host is “pushing” command information to the graphics controller. This information is in one of two forms:

- 1) A sequence of register writes to setup the state of a processing engine on the graphics controller, and then starting the engine running. Typically, engines are started as a side-effect of writing to a special “trigger” or “initiator” register.
- 2) A sequence of *Command Packets*, which are a “compressed” way of conveying the command information to the graphics controller, relying on an intelligent processor in the graphics controller to convert the command packets into register writes to other processing engines in the graphics controller.

It is expected that option (1) above will only be used for debug purposes.

The *Pull Model* utilizes bus-mastering on the part of the graphics controller, as it actively goes out and reads from an area of system memory in which the host CPU has previously placed command information. An important part of the pull model is how the host and the graphics controller manage access to the shared buffer in system memory. This is discussed in the following section.

The pull model allows more slip between the CPU and the graphics controller than does the push model, assuming that the command buffer for the push model is limited to on-chip storage.

The push model may have some advantage when the overall system performance is taken into account as it lightens the bandwidth demand on system memory as compared to the pull model. The push model may be able to make-up

for its limited slip by implementing an on-chip command buffer that “spills-over” into the frame buffer; however, this of course begins to place a demand on the frame buffer bandwidth to write and read the command buffer.

The Command Processor will support both the push and pull models; however, switching between these two models must be carefully controlled. It is intended that switching is not done often; most likely the model is chosen at reset time, and never changed once the system is running. The pull model is the preferred choice for systems that allow bus-mastering, and whose API allows concurrent processing between the host CPU and the graphics controller, primarily because of its superior capability for overlapped processing. The push model is available for systems that are not well-suited to using the pull model.

4.4 Ring Buffer Management

When the Graphics Controller is set to operate in the bus-mastering mode (pull model), the host application, say a driver, has to allocate a block of system memory as a buffer for the *command packets* it issues to the Graphics Controller. The command packets, or simply packets, instruct the Graphics Controller to carry out operations such as drawing objects on the screen. This memory block is treated as if it is a ring that allows the packets to be placed into and taken away from the memory in a circular manner, thus the name *Ring Buffer*.

The Ring Buffer is a shared memory space between two cooperating processors. It is used to implement one-way communication from the Host processor (the Writer) to the Graphics Controller (the Reader). Each processor must maintain the state that it believes that the Ring Buffer is in. The state is composed of:

- Buffer Base: The address of the beginning of the buffer.
- Buffer Size: The size of the buffer.
- Write Pointer: The address that the Host is writing to.
- Read Pointer: The address that the Graphics Controller is reading from.

In order for the Ring Buffer to work properly, both processors must maintain a consistent view of this state. The Buffer Base and Buffer Size are generally initialized when the system is first brought-up, and rarely changed after that point. It is a simple task to initialize both the Reader’s and the Writer’s copies of this state. The Read and Write Pointers, on the other hand, change quite frequently as the Ring Buffer is in operation. In order to achieve consistency, when the Writer (the host) updates the Write Pointer, he must send that value to the Reader’s (the Graphics Controller’s) copy of the Write Pointer. And similarly, when the Reader updates the Read Pointer, he must send that value to the Writer’s copy of the Read Pointer.

Packets are placed into the memory block, or buffer, from the beginning towards the end, i.e., from lower addresses toward higher addresses. Once the data placement hits the end, it starts from the beginning again. Meanwhile, the packets are consumed from the head of the queue in a manner similar to how they were placed.

Figure illustrates how the ring buffer operates when combined with the bus-mastering operation.

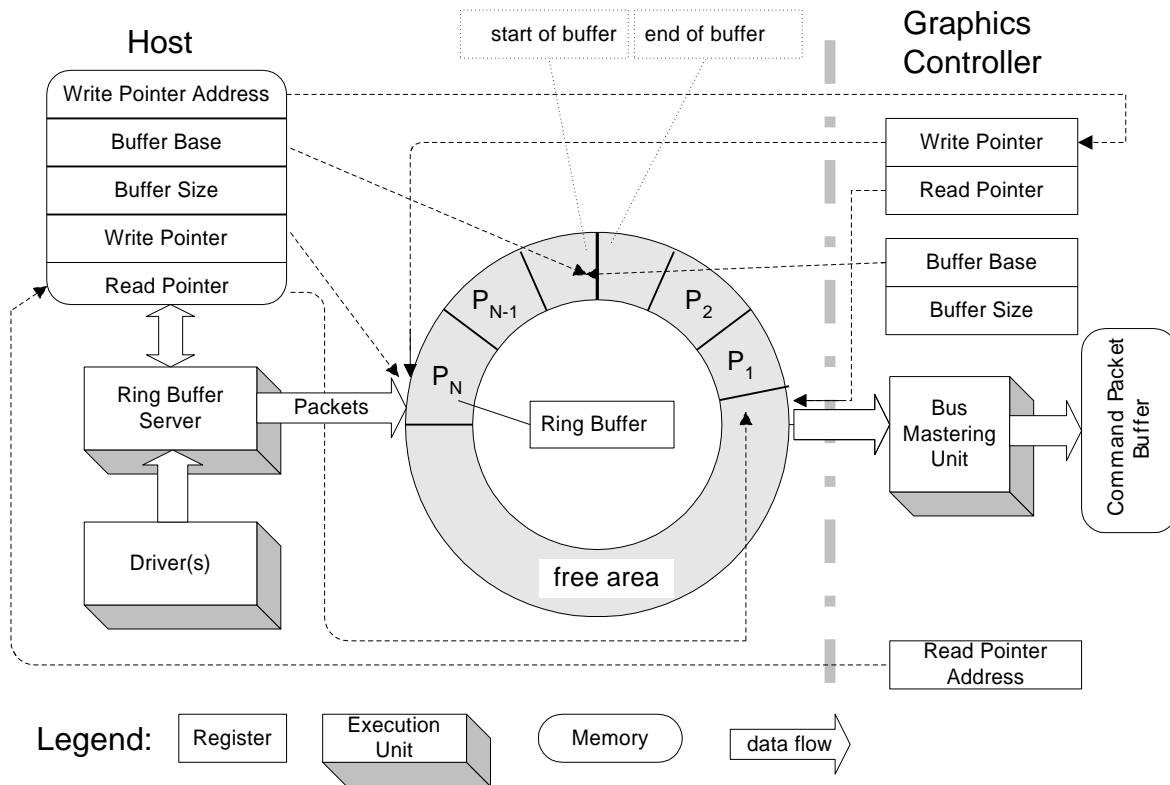

Figure: Ring Buffer and its Control Structure

In the figure, packets are placed into the buffer in a counter-clockwise order, forming a *packet queue*. The first packet in the queue is denoted by P_1 , and the last by P_n . The start of the queue, P_1 , is pointed to by the Read Pointer(s). The memory portion that is not occupied by packets is called the *free area*, and it is pointed to by the Write Pointer(s).

Initially, both the read and write pointers may point to the same location of the ring buffer, e.g. the start of the memory block. The two pointers pointing to the same location of the ring buffer generally implies one of two situations. One is that the buffer is empty, and the other is that the buffer is full. We want to define this situation as an empty buffer. To resolve the ambiguity of both pointers being equal, we must prevent the case of a full buffer from ever happening. It is the Host's responsibility to ensure that there is at least one free location in the buffer.

On the host side, the driver places command packets into the free area of the ring buffer, and informs the Graphics Controller of any changes to the Write Pointer by writing directly to the Write Pointer register inside the Graphics Controller. The host tracks free-space in the buffer by comparing its Read and Write Pointers, and suspends writing if the buffer becomes (almost) full.

On the Graphics Controller side, packets are taken away one-by-one from the head of the packet queue, pointed to by its Read Pointer, through the Host Bus Interface, and placed into the Command Packet Buffer. As the Graphics Controller updates its copy of the Read Pointer, it uses a bus-mastering write to update the Host's copy of the Read Pointer, residing in a shared memory location. The Graphics Controller has a register that holds the memory address of where the Host's Read Pointer resides, and uses that for the address of the bus-mastering write. The Graphics Controller tracks free-space in the buffer by comparing its Read and Write Pointers, and suspends reading if the buffer becomes empty (i.e., Read Pointer == Write Pointer).

To reduce traffic on the system memory bus, the Graphics Controller should not update the Host's copy of the Read Pointer every time it changes on the Graphics Controller side. To facilitate this, we have adopted a concept of a

block of dwords in the packet queue. The Graphics Controller will update the host's copy of the Read Pointer every time it has consumed a "block's-worth" of data from the ring buffer. The other time when the Graphics Controller will update the Read Pointer is when it thinks that the packet queue is empty. The size of the block is programmable, to allow the programmer to trade-off the amount of time the system bus spends doing real data transfer vs the amount of time it spends on the communication overhead of updating read/write pointers. Larger block sizes tend to reduce communication overhead, at the "expense" of reducing the number of blocks in the queue, which reduces the amount of "slip" (or de-coupling) between the Host and the Graphics Controller.

To reduce traffic on the system memory bus, the driver may want to minimize the frequency of accesses to its copies of the Read and Write Pointers. To minimize reads of the Read Pointer, it can check them once, calculate an amount of free space, and then decrement a local copy of the amount of free space as it adds packets to the queue. When it sees that the free-space is small (queue nearly full), it can start this procedure over again. (Its copy of the Read Pointer may have changed since the last time he read it.) The host also has the option of updating the Graphics Controller's Write Pointer on a less-frequent basis than with every write he does to the packet queue, possibly on a block-basis similar to the Graphics Controller's mechanism. However, if the buffer is running close to empty, any delay in updating the Graphics Controller's Write Pointer may add latency to the Graphics Controller's response to this command packet. Also, the host must be careful to update the Graphics Controller's copy of the Write Pointer if it wants the Graphics Controller to read from the queue until it is empty.

When the queue has become (almost) full, the host will have to poll the Read Pointer until space becomes available. In certain systems (Pentium II for example), this polling will stay within the processor cache, thus avoiding traffic on the system bus, and the snoop logic of the host CPU will take care of maintaining consistency between the main memory and the processor cache when the Graphics Controller performs its bus-mastering write of the Read Pointer. It is important to note that the Read Pointer must reside in PCI space in order for this snoop technique to work. AGP writes are not snooped.

4.5 Chipset Coherency Issues

The Rage128 product revealed a weakness in some motherboard chipsets in that there is no mechanism to guarantee that data written by the CPU to memory is actually in a readable state before the Graphics Controller receives an update to its copy of the Write Pointer. In an effort to alleviate this problem, we've introduced a mechanism into the Graphics Controller that will delay the actual write to the Write Pointer for some programmable amount of time, in order to give the chipset time to flush its internal write buffers to memory.

There are two register fields that control this mechanism: `PRE_WRITE_TIMER` and `PRE_WRITE_LIMIT`. There is also a staging register placed "in front of" the actual Write Pointer register of the CP. All host writes go into the staging register and are held there until one of two events occurs: the down-counter of `PRE_WRITE_TIMER` has expired; or the host has written the staging register `PRE_WRITE_LIMIT`-times, forcing the contents of the staging register into the actual Write Pointer register. The down-counter is seeded with `PRE_WRITE_TIMER` every time the host writes to the Write Pointer register address, and expires when it reaches zero. This implementation does not **guarantee** a certain time-delay between the host write to the Write Pointer, and the Graphics Controller read of the system memory; because the host could flood the Graphics Controller with multiple writes (more than the `PRE_WRITE_LIMIT`) in a short amount of time, thus overriding the time-delay imposed by the `PRE_WRITE_TIMER`. However, since the normal operation of this system is to increase the Write Pointer by some significant amount with each write, it is likely that by the time the `PRE_WRITE_LIMIT` has been reached, the data has in fact been "pushed" through the chipset's write buffer by subsequent writes to the ring buffer in system memory.

Note that programming the `PRE_WRITE_TIMER` and `PRE_WRITE_LIMIT` to zero allows the chip to behave just as the Rage128 did.

The above solution is based on a **time** delay, the assumption being that if the chipset is given enough time, the write buffer will be flushed to memory, and become available for a coherent read.

4.6 Indirect Buffer Management

The Command Processor has the capability to read commands from other locations in memory, outside of the Ring

Buffer. These locations are known as Indirect Buffer1 and Indirect Buffer2. This is accomplished as follows: there is a packet in the Primary command stream (being read from the ring buffer) which sets up the Indirect Buffer1 Address and Size registers of the Command Processor. The writing of the Indirect Buffer1 Size register triggers the Command Processor to begin fetching the new stream from the provided address. The last packet to be parsed from the Primary stream is the one that sets the Indirect Buffer1 Address and Size registers. The CP then begins fetching data from Indirect Buffer1. The data stream in Indirect Buffer1 may set up the Indirect Buffer2 Address and Size registers of the Command Processor. As before, writing of the Indirect Buffer1 Size register triggers the Command Processor to begin fetching the new stream from the provided address. The last packet to be parsed from the Indirect Buffer1 stream is the one that sets the Indirect Buffer2 Address and Size registers. The CP fetches the correct amount of data from Indirect Buffer2 until The Buffer2 Size is exhausted; it then returns to its interpretation of packets from Indirect Buffer1. The CP fetches the correct amount of data from Indirect Buffer1 until the Buffer1 Size is exhausted; it then returns to its interpretation of packets from the Primary Stream (being read from the ring buffer).

4.7 Overview of DMA Operation

The DMA engines in the Command Processor fetch commands from the frame buffer memory which tell them what to do. The command in memory is stored in a structure known as a *Descriptor*, having a four-dword (DWORD) format as shown below:

Ordinal	Name	Bit	Function
0	SRC_ADDR	31:0	Source address
1	DST_ADDR	31:0	Destination address
2	COMMAND	31:0	Command word. (See description below)
3	(Reserved)	31:0	

The COMMAND word has the following format:

31	EOL	End Of List Marker
30	INTDIS	Interrupt Disable
29	DAIC	Destination Address Increment Control
28	SAIC	Source Address Increment Control
27	DAS	Destination Address Space
26	SAS	Source Address Space
25:24	DST_SWAP	Destination Endian Swap Control
23:22	SRC_SWAP	Source Endian Swap Control
20:0	BYTE_COUNT[20:0]	Byte Count of Transfer

There are some constraints on the programming of the Descriptor, as follows: If either the Source or the Destination is in the register address space, or is programmed to be non-incrementing, then the atomic transfer unit is assumed to be a DWORD. Namely, the bottom two-bits of the BYTE_COUNT and the Address will be ignored (assumed "00").

Note that a BYTE_COUNT of zero will perform no operation.

Multiple Descriptors may be stored contiguously in memory to make up a *Descriptor Table (DT)* (see Figure). The last Descriptor in the Descriptor Table must be marked as such so that the DMA engine knows when to stop consuming commands.

The programmer provides the DMA engine with a pointer to the beginning of the Descriptor Table, and the DMA

engine fetches one Descriptor at a time, interprets the command to carry out a transfer, and then moves on to the next Descriptor in the table. As mentioned above, the DMA engine will stop when it reaches the last Descriptor in the table.

There is a bit called CP_SYNC in the Descriptor Address register (DMA_XXX_TABLE_ADDR). If this bit is set, the DMA will “lock-out” the microengine from performing any writes on the register backbone while the DMA is active. This mechanism can be used to synchronize a DMA-driven stream of register writes to the command FIFO, among other things.

A DMA channel may have its operation aborted by writing a ‘1’ to the ABORT_EN bit of the DMA_XXX_STATUS register. It is important that the programmer then poll the ACTIVE bit of that same register, waiting for a value of ‘0’, before writing a ‘0’ to the ABORT_EN bit. Once the ACTIVE bit is ‘0’, the programmer is guaranteed to read-back stable state from all DMA registers.

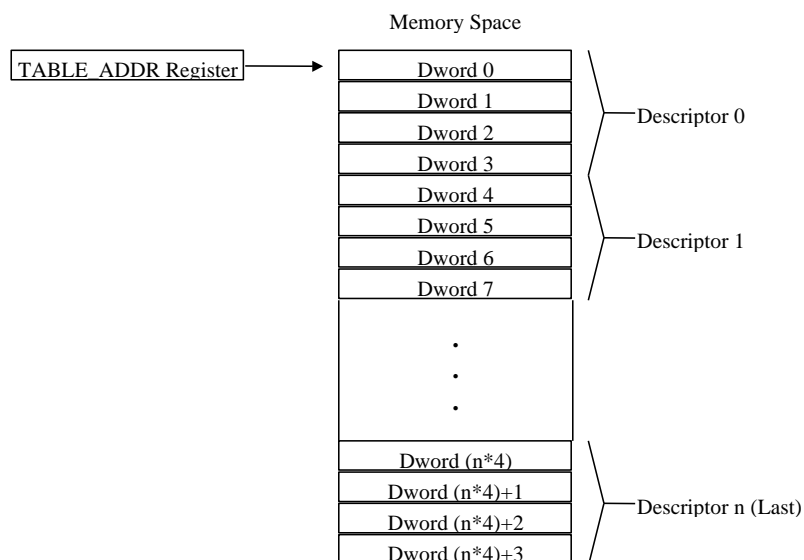

Figure: Descriptor Table Layout in Memory

An alternate method to writing the DMA_XXX_TABLE_ADDR register to initiate a DMA operation is to write the descriptors directly to the CP. This saves the fetching of the descriptor table from memory.

Three registers are provided for each of the DMA engines (CP_XXX_SRC_ADDR, CP_XXX_DST_ADDR, CP_XXX_COMMAND). The contents of these registers have the same fields as the SRC_ADDR, DST_ADDR, and COMMAND DWORDs of the descriptor table entry described above. Except that the EOL is hard-coded TRUE in the COMMAND DWORD. Writing to the CP_XXX_COMMAND register initiates a DMA operation using the descriptor described in all three registers. A table of descriptors can be built from multiple Type-0 packets each containing the SRC, DST, and COMMAND data.

4.8 Resetting the Command Processor

To support recovery from a power-down state the read pointer (CP_RB_RPTR) is writable. The read pointer is initialized by writing the writable read pointer (CP_RB_RPTR_WR). Then, when the write pointer (CP_RB_WPTR) is subsequently written the contents of the writable read pointer (CP_RB_RPTR_WR) are transferred to the active read pointer (CP_RB_RPTR). As a precaution, an enable bit must be set in the control register (CP_RB_CNTL) to allow the contents to transfer to the active read pointer (CP_RB_RPTR). Note that the read pointer still resets to zero to ensure starting at the beginning of the buffer if the host does not initialize the writable read pointer (CP_RB_RPTR_WR).

Therefore, a certain sequence of actions is required of the host in order to perform a “clean” soft reset of the CP:

- 1) Write CP_CSQ_CNTL and CP_CSQ_MODE to zero, effectively disabling the CP.
- 2) Write to the proper RBBM register to assert and then de-assert the Soft Reset signal to the CP.
- 3) Set the RB_RPTR_WR_ENA bit to enable writing of the RPTR if desired not to start from the beginning of the buffer.
- 4) Write the CP_RB_RPTR_WR register if it is desired not to start at the beginning of the buffer.
- 5) Write CP_RB_WPTR, to make it match the RPTR, causing the ring buffer to appear to be empty.
- 6) Clear the RB_RPTR_WR_ENA bit if no further writes of the RPTR are desired.
- 7) Write CP_CSQ_CNTL or CP_CSQ_MODE to set the mode back to whatever you want.

4.9 Command Stream Synchronization

In the RBBM, there is an event engine that can be used to synchronize the sending of transactions to the Register Backbone based on status signals from its clients. The CP however has a mechanism that can directly provide the Host with knowledge of command status. This mechanism is the eight “SCRATCH” registers and their associated functionality.

Associated with the eight “SCRATCH” registers in the CP are a scratch address register and a write mask. When a scratch register is written, the CP will subsequently write its value to a location equal to what is programmed in the SCRATCH_ADDR register plus the number (0 to 7) of the scratch register. The writing of the scratch register’s value by the CP is qualified by the register’s write mask (SCRATCH_UMSK).

So, at the end of processing an Indirect Buffer, for example, a Type-0 packet can be inserted that writes a data pattern to SCRATCH_REG1. The driver software can poll the external location SCRATCH_ADDR+1 and when it changes to the value that was inserted in the Type-0 packet, the Driver will “know” that the CP has completed parsing the indirect buffer up to that point. Note that this status only indicates that the CP is done to that point, the data still may be being used by the rest of the pipeline.

For R5xx an interrupt is added associated with the scratch registers, which is asserted when the scratch register pair selected is written to memory and is greater than or equal to the pair of values written by the Driver.

The CP can receive sync pulses from the back-end of the pipeline (CBA_CP_SYNC, CBB_CP_SYNC, CBC_CP_SYNC, and CBD_CP_SYNC). When a pulse from each is received (pulse pair), the CP will write the targeted scratch register with the corresponding CP_RESYNC_DATA value. The targeted scratch register is determined by the 3-bit CP_RESYNC_ADDR which is a scratch register offset from the SCRATCH_ADDR base address.

Because this function uses the SCRATCH_ADDR and SCRATCH_UMSK values, they must be initialized prior to its use. The CP_RESYNC_ADDR and CP_RESYNC_DATA registers must also be programmed with the target scratch register offset and the appropriate data respectively before the pulses are received. Both the CP_RESYNC_ADDR and CP_RESYNC_DATA values are written into 8-deep FIFOs so that multiple synchronization events can be en-queued in the CP.

If the sync pulses from the CB are asserted before programming the CP_RESYNC_ADDR and CP_RESYNC_DATA, the logic will still work providing that Dynamic Clocking for the CP is disabled. Receipt of the sync pulses by the CP does not cause the clocks to be enabled to the CP, so knowledge of these pulses may not be remembered if Dynamic Clocking is enabled. Writing the CP_RESYNC_ADDR and CP_RESYNC_DATA registers does enable the clocks to the CP. The “busy” signal to the CG will remain asserted as long as there is RESYNC data in the ADDR and DATA FIFOs – keeping the clock enabled to the CP.

4.10 Starting the Indirect Streams

A write to the CP_IB_BUFSZ register triggers the Command Processor to start fetching the command stream from the Indirect1 buffer, instead of from the Primary buffer. The CP will continue to fetch from the Indirect1 buffer, starting at the address in the CP_IB_BASE register, and continuing until the CP_IB_BUFSZ amount is exhausted. Then it will switch back to the Primary stream.

A write to the CP_IB2_BUFSZ register triggers the Command Processor to start fetching the command stream from the Indirect2 buffer, instead of from the Indirect1 buffer. The CP will continue to fetch from the Indirect2 buffer, starting at the address in the CP_IB2_BASE register, and continuing until the CP_IB2_BUFSZ amount is exhausted. Then it will switch back to the Indirect1 stream.

Note that there are some important rules to follow when starting an indirect stream. Firstly, the write to the CP_IB_BUFSZ or CP_IB2_BUFSZ register must be the **last** register-write of a Type 0 or Type 1 packet. The very next packet that is delivered to the Command Stream Interpreter is the first packet of the respective indirect buffer. The second rule is that the respective CP_IB_BASE or CP_IB2_BASE register must have been setup with the proper value before the appropriate CP_IB_BUFSZ or CP_IB2_BUFSZ register is written.

In PIO mode, the BUFSZ register still needs to be written with the size of the indirect buffer. Care must be taken to write this register before the command queue fills in the CP.

4.11 Writing Host Data to the Command Stream Queue

Either or all of the Primary, Indirect1 and Indirect2 streams can be delivered to the Command Processor via host-programmed writes to the Graphics Controller device. There is a range of register-space addresses assigned to each of the three streams, that is, one aperture for the Primary Stream, one for the Indirect1 Stream, and one for the Indirect2 Stream. The act of writing to a location in the aperture causes that data to be enqueued to the Command Stream Queue. Note that the actual address of the written data is inconsequential; the data will be enqueued into the Command Stream Queue in the **order** in which it was received from the host.

Note that each of the three streams can be in one of three delivery modes, resulting in nine possible combinations. The three modes are:

- 1) OFF: The stream is disabled.
- 2) PUSH: The host is writing the stream data to the Command Processor. (also known as Programmed I/O, or PIO mode)
- 3) PULL: The Command Processor is actively fetching the command stream from memory. (also known as Bus Master, or BM mode)

Note that the BUFSZ register must be written to initiate indirect buffer parsing in the “PUSH” mode.

4.12 Writing to the MicroEngine RAM

In order to change a location in the MicroEngine RAM, first load the CP_ME_RAM_ADDR Register with the address of the RAM into which data is to be written. Next, the host performs two writes; the first must be to the CP_ME_RAM_DATAH port, and the second to the CP_ME_RAM_DATAL port. Internally, the Command Processor maintains a 40-bit holding registers which concatenates the lower 8-bits of the DATAH value to the top of the 32-bit DATAL value, and at the end of the write of the DATAL value, the 40-bit value is written to the RAM at the location specified by the RAM Address Register. The RAM Address Register is then auto-incremented to point to the next location in the RAM. This process of writing two data values may be repeated to write to successive RAM locations without re-loading the RAM Address Register.

4.13 Reading from the MicroEngine RAM

In order to read a location in the MicroEngine RAM, first load the CP_ME_RAM_RADDR Register with the address of the RAM from which data is to be read. This write triggers the Command Processor to read the 40-bit data value at that RAM location and transfer it to an internal 40-bit holding register. Also, the RAM Address Register is auto-incremented to point to the next location in the RAM. Next, the host performs two read cycles, the first from the DATAH port, and the second from the DATAL port. At the end of the DATAL cycle, the next location of the RAM is transferred to the 40-bit holding register, and the RAM Address Register is again auto-incremented. This process of reading two values may be repeated to read from successive RAM locations without re-loading the RAM Address Register.

4.14 Starting a DMA Operation

There are two methods to initiate a DMA operation – Descriptor Tables or Direct Descriptor Entry Register Writes.

To program a DMA operation via Descriptor Tables, the programmer has to build the table in the frame buffer first, being sure to mark the last entry of the list as “End Of List”. Then, the programmer can write the starting address of the descriptor table into the Descriptor Table Address Queue (DTAQ) through the `xxx_DMA_TABLE_ADDR` port. The action of writing the first starting address into the DTAQ will trigger the DMA operation.

The type of transfer operation depends on the `DMA_COMMAND` DWORD in the Descriptor. It controls such variables as: the length of the transfer, whether the Source/Destination addresses are in memory-space or register-space, whether the Source/Destination addresses auto-increment with each transfer, and whether an interrupt is generated when the entire Descriptor Table has been processed.

The second method - Direct Descriptor Entry Register Writes – involves writing the three DMA Entry registers. Three registers are provided for each of the DMA engines (`CP_XXX_SRC_ADDR`, `CP_XXX_DST_ADDR`, `CP_XXX_COMMAND`). The contents of these registers have the same fields as the `SRC_ADDR`, `DST_ADDR`, and `COMMAND` DWORDs of the descriptor table entry. Except that the EOL is hard-coded TRUE in the `COMMAND` DWORD. Writing to the `CP_XXX_COMMAND` register initiates a DMA operation using the descriptor described in all three registers. A table of descriptors can be built from multiple Type-0 packets each containing the `SRC`, `DST`, and `COMMAND` data.

5. PM4

5.1 Packet Types

When programming in the PM4 mode, we do not need to write directly to registers to carry out drawing operations on the screen. Instead, what we need to do is to prepare data in the format of PM4 *Command Packets* in the system memory, and let the hardware (Microengine) to do the rest of the job.

Four types of PM4 command packets are currently defined. They are types 0, 1, 2 and 3 as shown in the following figure. A PM4 command packet consists of a *packet header*, identified by field HEADER, and an *information body*, identified by IT_BODY, that follows the header. The packet header defines the operations to be carried out by the PM4 micro-engine, and the information body contains the data to be used by the engine in carrying out the operation. In the following, we use brackets [.] to denote a 32-bit field (referred to as DWORD) in a packet, and braces {.} to denote a size-varying field that may consist of a number of DWORDs. If a DWORD is shared by more than one field, the fields are separated by '|'. The field that appears on the far left takes the most significant bits, and the field that appears on the far right takes the least significant bits. For example, DWORD [HI_WORD | LO_WORD] denotes that HI_WORD is defined on bits 16-31, and LO_WORD on bits 0-15. A C-style notation of referencing an element of a structure is used to refer to a subfield of a main field. For example, MAIN_FIELD.SUBFIELD refers to the subfield SUBFIELD of MAIN_FIELD.

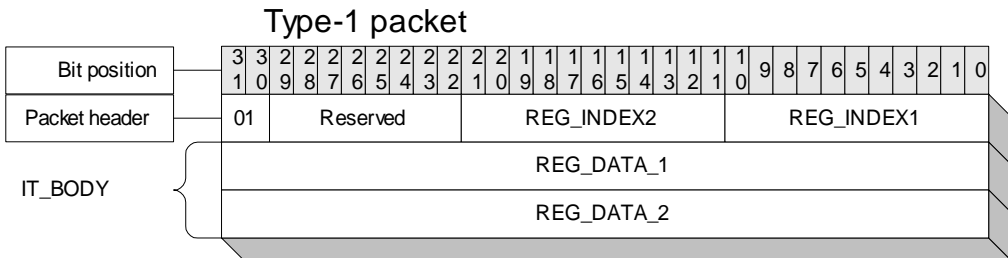
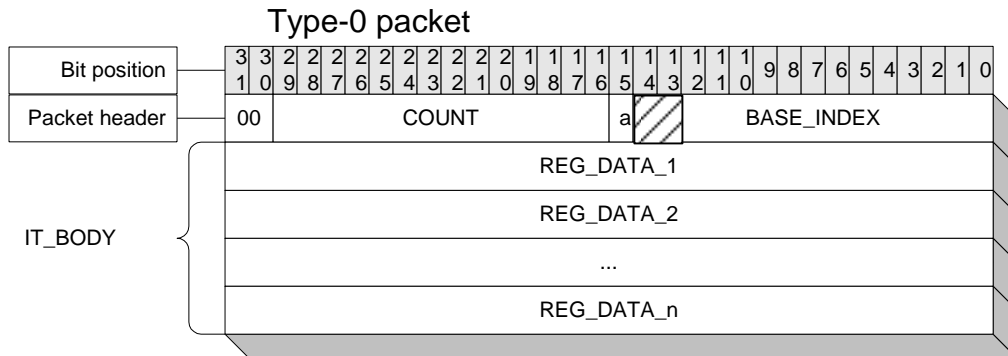

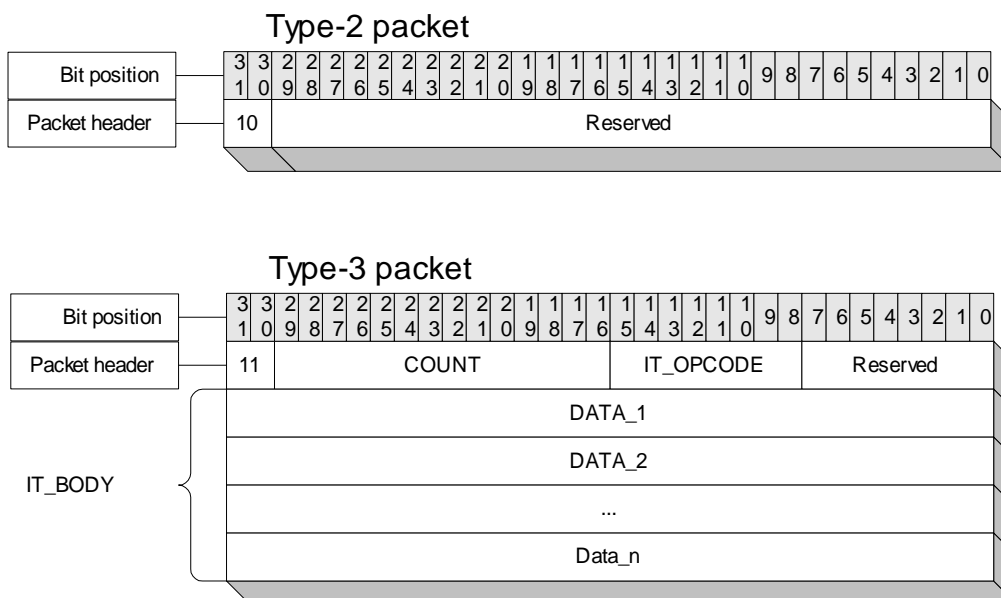

5.1.1 Type-0 Packet

Functionality

Write *N* DWORDs in the information body to the *N* consecutive registers, or to the register, pointed to by the BASE_INDEX field of the packet header.

Format

Ordinal	Field Name
1	[HEADER]
2	[REG_DATA_1]
3	[REG_DATA_2]
	...
N+1	[REG_DATA_N]

Header Fields

Bit(s)	Field Name	Description
12:0	BASE_INDEX	The BASE_INDEX[12:0] correspond to byte address bits [14:2]. So the BASE_INDEX is the DWORD Memory-mapped address. The BASE_INDEX field width supports up to DWORD address: 0x7FFF.
14:13	Reserved	Reserved for future expansion of address space.
15	ONE_REG_WR	0:- Write the data to N consecutive registers. 1:- Write all the data to the same register.
29:16	COUNT	Count of DWORDs in the information body. Its value should be N-1 if there are N DWORDs in the information body.
31:30	TYPE	Packet identifier. It should be zero.

Note: Symbol ‘:-’ reads “defined as.”

Information Body

Bit(s)	Field Name	Description
31:0	REG_DATA_x	The bits correspond to those defined for the relevant register. Note the suffix x of REG_DATA_x stands for an integer ranging from 1 to N.

Comment

The use of this packet requires the complete understanding of the registers to be written.

5.1.2 Type-1 Packet

Functionality

Write REG_DATA_1 and REG_DATA_2 in the information body respectively to the registers pointed to by REG_INDEX1 and REG_INDEX2. Note that this packet cannot address the entire address space. It is recommended that Type 0 packets be used instead.

Format

Ordinal	Field Name
1	[HEADER]
2	[REG_DATA_1]
3	[REG_DATA_2]

Header fields

Bit(s)	Field Name	Description
10:0	REG_INDEX1	The field points to a memory-mapped register that REG_DATA_1 is written to.
21:11	REG_INDEX2	The field points to a memory-mapped register that REG_DATA_2 is written to.
29:22	Reserved	
31:30	TYPE	Packet identifier. It should be 1 (one).

Information Body

Bit(s)	Field Name	Description
31:0	REG_DATA_x	The bits correspond to those defined for the relevant register.

5.1.3 Type-2 Packet

Functionality

This is a filler packet. It has only the header, and its content is not important except for bits 30 and 31. It is used to fill up the trailing space left when the allocated buffer for a packet, or packets, is not fully filled. This allows the microengine to skip the trailing space and to fetch the next packet.

Format

Ordinal	Field Name
1	[HEADER]

Header fields

Bit(s)	Field Name	Description
29:0	reserved	

31:30	TYPE	Packet identifier. It should be 2.
-------	------	------------------------------------

5.1.4 Type-3 Packet

Functionality

Carry out the operation indicated by field IT_OPCODE.

Format

Ordinal	Field Name
1	[HEADER]
2	{IT_BODY}

Header fields

Bit(s)	Field Name	Description
7:0	Reserved	This field is undefined, and is set to zero by default.
15:8	IT_OPCODE	Operation to be carried out. See section B.2 for details.
29:16	COUNT	Number of DWORDs -1 in the information body. It is N-1 if the information body contains N DWORDs.
31:30	TYPE	Packet identifier. It should be 3.

Information Body

The information body IT_BODY will be described extensively in the following section.

5.2 Definition of Type-3 packets

Type-3 packets has a common format in their headers. However, the size of their information body may vary depending on the value of field `IT_OPCODE`. The size of the information body is indicated by field `COUNT`. If the size of the information is N DWORDs, the value of `COUNT` is $N-1$. In the following packet definitions, we will describe the field `IT_BODY` for each packet with respect to a given `IT_OPCODE`, and omit the header. The MSB of the `IT_OPCODE` identifies whether this packet requires the `GUI_CONTROL` field (described later). A 1 in the MSB of the `IT_OPCODE` indicates that GUI control is required. A 0 in the MSB of the `IT_OPCODE` indicates that the `GUI_CONTROL` should be omitted.

5.2.1 Summary of packets

Packet Name	IT_OPCODE	Description
NOP	0x10	Skip N DWORDs to get to the next packet.
PAINT	0x91	Paint a number of rectangles with a colour brush.
BITBLT	0x92	Copy a source rectangle to a destination rectangle.
HOSTDATA_BLT	0x94	Draw a string of large characters on the screen, or copy a number of bitmaps to the video memory.
POLYLINE	0x95	Draw a polyline (lines connected with their ends).
POLYSCANLINES	0x98	Draw polyscanlines or scanlines.
NEXTCHAR	0x19	Print a character at a given screen location using the default foreground and background colours.
PAINT_MULTI	0x9A	Paint a number of rectangles on the screen with one colour. The difference between this function and PAINT is the representation of parameters.
BITBLT_MULTI	0x9B	Copy a number of source rectangles to destination rectangles of the screen respectively.
TRANS_BITBLT	0x9C	2D transparent bitblt operation.
PLY_NEXTSCAN	0x1D	Draw polyscanlines using current settings.
SET_SCISSORS	0x1E	Set up scissors.
PRED_EXEC	0x20	Predicated execute wrapper for a sequence of packets
COND_EXEC	0x21	Conditional execute wrapper for a sequence of packets
WAIT_SEMAPHORE	0x22	Wait in the CP micro-engine for semaphore to be zero
WAIT_MEM	0x23	Wait in the CP micro-engine for GPU-accessible memory semaphore to be zero
3D_DRAW_VBUF	0x28	Draw primitives using vertex buffer
3D_DRAW_IMMD	0x29	Draw primitives using immediate vertices in this packet
3D_DRAW_INDX	0x2A	Draw primitives using vertex buffer and indices in this packet
LOAD_PALETTE	0x2C	Load a palette for 2D scaling.
3D_LOAD_VBPNTNTR	0x2F	Load pointers to vertex buffers
INDX_BUFFER	0x33	Load Indices Using Indirect Buffer #2
3D_DRAW_VBUF_2	0x34	Same as 3D_DRAW_VBUF, but without VAP_VTX_FMT
3D_DRAW_IMMD_2	0x35	Same as 3D_DRAW_IMMD, but without VAP_VTX_FMT
3D_DRAW_INDX_2	0x36	Same as 3D_DRAW_INDX, but without VAP_VTX_FMT
3D_CLEAR_HIZ	0x37	Clear portion of the Hierarchal Z RAM
3D_DRAW_128	0x39	Draw packet to write to 128-bit VAP data port.
MPEG_INDEX	0x3A	MPEG Packet Registers and Index Generation

5.2.2 2D Packets

The information body IT_BODY of 2-D packets may have the following format:

Ordinal	Field Name
1	{SETTINGS}
2	{DATA_BLOCK}

SETTINGS

This field consists of 2 subfields, GUI_CONTROL and SETUP_BODY.

Ordinal	Field Name
1	[GUI_CONTROL]
2	{SETUP_BODY}

- **SETTINGS.GUI_CONTROL**

This field will be used to setup the register DP_GUI_MASTER_CNTL, and it also decides the content of SETTINGS.SETUP_BODY.

Bit(s)	Field Name	Description	Status
0	SRC_PITCH_OFF	The bit controls the pitch and offset of the blitting source. 0:- Use the default pitch and offset, and no datum [SRC_PITCH_OFFSET] is supplied in SETUP_BODY. 1:- Use the datum [SRC_PITCH_OFFSET] supplied in SETUP_BODY to set up a new pitch offset.	
1	DST_PITCH_OFF	The bit controls the pitch and offset of the blitting destination. 0:- Use the default pitch and offset, and no datum [DST_PITCH_OFFSET] is supplied in SETUP_BODY. 1:- Use the datum [DST_PITCH_OFFSET] supplied in SETUP_BODY. The pitch may mean the bitmap pitch and the offset may points the off-screen area of the video memory.	
2	SRC_CLIPPING	This bit controls the clipping parameters of the blitting source. 0:- Use the default clipping parameters, and no relevant clipping data supplied in SETUP_BODY. 1:- Use datum [SRC_SC_BOT_RITE] supplied in SETUP_BODY to set up the bottom and right edges of the clipping rectangle.	
3	DST_CLIPPING	This bit controls the clipping parameters of the blitting destination. 0:- Use the default clipping parameters, and no relevant clipping data supplied in SETUP_BODY. 1:- Use data [SC_TOP_LEFT] and [SC_BOTTOM_RIGHT] supplied in SETUP_BODY to set up a new clipping rectangle.	
7:4	BRUSH_TYPE	Types of brush used in drawing. The type code determines how to supply data to the subfield BRUSH_PACKET in SETUP_BODY. See detailed definition of BRUSH_TYPE in the following.	
11:8	DST_TYPE {Not Used by uCode}	The pixel type of the destination. 0--1 :- (reserved) 2 :- 8 bpp pseudocolor 3 :- 16 bpp aRGB 1555 4 :- 16 bpp RGB 565 5 :- reserved 6 :- 32 bpp aRGB 8888 7 :- 8 bpp RGB 332 8 :- Y8 greyscale 9 :- RGB8 greyscale (8 bit intensity, duplicated for all 3 channels. Green channel is used on writes) 10 :- (reserved) 11 :- YUV 422 packed (VYUY) 12 :- YUV 422 packed (YVYU) 13 :- (reserved)	7 through 15 not supported in 3D pipe

		14 :- aYUV 444 (8:8:8:8) 15 :- aRGB4444 (intermediate format only. Not understood by the Display Controller) Note: choices 7-15 only valid in 3D mode.	
13:12	SRC_TYPE {Not Used by uCode}	The field indicates the pixel type of blitting source. 0:- The source data type is mono opaque, and the fore- and back-ground colours need to be redefined. 1:- The source data type is mono transparent, and only the foreground colour needs to be redefined. 2:- Reserved. 3:- The source pixel type is the same as that given in field DST_TYPE. If bit 27 (SRC_TYPE) is one then the following new sources are available: 4:- 4bpp source clut translation (May not be supported, value reserved) 5:- 8bpp source clut translation 6:- 32 bpp source clut translation (gamma correction) 7:- 64 bpp Obuffer blit	
14	PIX_ORDER {Not Used by uCode}	The bit decides the order of bits (or pixels) in DWORD to be consumed. Only applicable to the monochrome mode. 0 :- Bits to be consumed from the Most Significant Bit (MSB) to the Least Significant Bit (LSB). 1 :- Bits to be consumed from LSB to MSB.	
15	COLOR_CONVT {Not Used by uCode}	Reserved	Not supported in 2D pipe
23:16	WIN31_ROP {Not Used by uCode}	This field tells the GUI engine how the raster operation to be carried out. The code of this field follows the ROP3 code defined by Microsoft. See WIN31 DDK for reference.	
26:24	SRC_LOAD {Not Used by uCode}	The field indicates where the source data come from. 0,1 :- Reserved 2 :- loaded from the video memory (rectangular trajectory) 3 :- loaded through the HOSTDATA registers (linear trajectory) 4 :- loaded through the HOSTDATA registers (linear trajectory & byte-aligned) Note that during 3D/Scale Operations (whenever SCALE_3D_FCN@MISC_3D_STATE_REG is non-zero), this field is ignored and data is always loaded from the 3D/Scaler pipeline.	
27	SRC_TYPE {Not Used by uCode}	Third bit of SRC_TYPE	Compatible 128 code must write zero to this register.
28	GMC_CLR_CMP_FCN_DIS {Not Used by uCode}	0 :- No change to CLR_CMP_FCN_SRC and CLR_CMP_FCN_DST 1 :- clear CLR_CMP_FCN_DST and CLR_CMP_FCN_SRC to 0	TBD
29	Reserved {Not Used by uCode}	Reserved	Reserved
30	GMC_WR_MSK_DIS {Not Used by uCode}	0 :- No Change to DP_WR_MSK/CLR_CMP_MSK 1 :- Set DP_WR_MSK/CLR_CMP_MSK to 0xffffffff	

31	BRUSH_FLAG	This field indicates whether there is a field BRUSH_Y_X field in the SETTINGS.SETUP_BODY. 0:- No such a field in SETTINGS.SETUP_BODY. 1:- There is a field in SETTINGS.SETUP_BODY.	
----	------------	--	--

- **SETTINGS.SETUP_BODY**

This field may contain the following subfields. Their presence depends on the bits 0-7 of **SETTINGS.GUI_CONTROL**.

Ordinal	Field Name	Description
1	[SRC_PITCH_OFFSET]	Bit 30: Select between untiled(0) and tiled (1) Bit 31: select between no microtiling(0) and microtiling(1) Bits 29:22 Pitch in units of 64 bytes, 64 to 16384 bytes across bits 21:0 Offset in units of 1KB, 0 to 4GB-1K
2	[DST_PITCH_OFFSET]	Bit 30: Select between untiled(0) and tiled (1) Bit 31: select between no microtiling(0) and microtiling(1) Bits 29:22 Pitch in units of 64 bytes, 64 to 16384 bytes across bits 21:0 Offset in units of 1KB, 0 to 4GB-1K
3	[SRC_SC_BOT_RITE]	The parameters are used to setup the clipping area of the source. The implied coordinates of the top-left corner of the clipping rectangle is the same as the source. [13:0] :- x-coordinate of the right edge of the clipping rectangle (in number of pixels). [29:16] :- y-coordinate of the bottom edge of the clipping rectangle (in number of scanlines).
4	[SC_TOP_LEFT] [SC_BOT_RITE]	The parameters are used to setup the clipping area of destination. SC_TOP_LEFT: [13:0] :- x-coordinate of the left edge of the clipping rectangle (in number of pixels). [29:16] :- y-coordinate of the top edge of the clipping rectangle (in number of scanlines). SC_BOT_RITE: [13:0] :- x-coordinate of the right edge of the clipping rectangle (in number of pixels). [29:16] :- y-coordinate of the bottom edge of the clipping rectangle (in number of scanlines).
5	{ BRUSH_PACKET }	The content of this field is determined by field SETTINGS.GUI_CONTROL.BRUSH_TYPE . See the following table for the possible content.
6	[BRUSH_Y_X]	[4:0] :- x-coordinate for brush alignment. [12:8] :- y-coordinate for brush alignment. [20:16] :- Initial value used for BRUSH_X pointer in drawing Lines. When POLY_LINE is off , it is reloaded from BRUSH_X at the end of the line. When POLY_LINE is on , it is reloaded from the current Brush pointer at the end of the line. Whenever BRUSH_X is updated, the field should be written with the same value.

- **SETTINGS.SETUP_BODY.BRUSH_PACKET**

Note that all but 6 and 7 are not available for lines, and 6 and 7 are only usable for lines.

BRUSH_TYPE	Description of the brush	Packet size	Packet content
0	A 8 x 8 mono pattern with the foreground and background colours specified in the packet. Here the matrix is represented in the format <i>column-by-row</i> .	4 DWORDs	[BKGRD_COLOR] [FRGRD_COLOR] [MONO_BMP_1] [MONO_BMP_2]
1	A 8 x 8 mono pattern with the foreground colour specified in the packet and the background colour the same as that of the area to be painted.	3 DWORDs	[FRGRD_COLOR] [MONO_BMP_1] [MONO_BMP_2]
2	Reserved	not applicable	
3	Reserved	not applicable	
4	Reserved	not applicable	
5	Reserved	not applicable	
6	A 32 x 1 mono pattern with the foreground and background colours specified in the packet. This pattern corresponds to the PEN of Win95 DDK. And is only usable for lines.	3 DWORDs	[BKGRD_COLOR] [FRGRD_COLOR] [MONO_BMP_1]
7	A 32x1 mono pattern with the foreground colour specified in the packet and the background colour the same as that of the area to be painted. This is PEN as well. And is only usable for lines.	2 DWORDs	[FRGRD_COLOR] [MONO_BMP_1]
8	Removed, see 32x32 in 3D pipe	not applicable	
9	Removed, see 32x32 in 3D pipe	not applicable	
10	A 8x8 colour pattern. The pixel type is given by field SETTINGS.GUI_CONTROL.DST_TYPE.	16* N DWORDs, where N stands for the number of bytes per pixel with exception that a 24-BPP pixel is still represented by 4 bytes.	[COLOR_BMP_1] [COLOR_BMP_2] ... [COLOR_BMP_16*N]
11	Reserved	not applicable	
12	Reserved	not applicable	
13	Use the colour specified in the packet as the solid (plain) colour for the brush, i.e. a colour brush without pattern.	1 DWORD	[FRGRD_COLOR]
14	Use the colour specified in the packet as the solid (plain) colour for the brush, i.e. a colour brush without pattern.	1 DWORD	[FRGRD_COLOR]
15	No brush used.	0	

Brush packet content

Field Name	Description
[FRGRD_COLOR]	The foreground colour of the text in the RGBQUAD format. bits [7:0] :- intensity of Blue; bits [15:8] :- intensity of Green; and bits [23:16] :- intensity of Red. bits [31:25] :- reserved.
[BKGRD_COLOR]	The background colour of the text in the RGBQUAD format. bits [7:0] :- intensity of Blue; bits [15:8] :- intensity of Green; and bits [23:16] :- intensity of Red. bits [31:25] :- reserved.
[MONO_BMP_x]	Raster data of monochrome pixels. One bit represents one pixel. If the number of pixels for the field is less than 32, the pixels take the lower bits. The remaining bits should be filled with 0's.
[COLOR_BMP_x]	Raster data of colour pixels. The representation depends on the pixel type.

DATA_BLOCK

The composition of this field depends on the operation code `IT_OPCODE` given in the header. Section B.2 gives details of `DATA_BLOCK` with respect to `IT_OPCODE`. In the following, the field `SETTINGS` may appear in the definition of a packet, but will not be described further.

5.2.2.1 NOP**Functionality**

Skip a number of DWORDs to get to the next packet.

Format

Ordinal	Field Name
1	[HEADER]
2	{DATA_BLOCK}

DATA_BLOCK

This field may consist of a number of DWORDs, and the content may be anything.

5.2.2.2 PAINT**Functionality**

Paint a number of rectangles with a colour brush.

Format

Ordinal	Field Name
1	[HEADER]
2	{SETTINGS}
3	{DATA_BLOCK}

DATA_BLOCK

Ordinal	Field Name	Description
1	[TOP_1 LEFT_1]	The coordinates of the top-left corner of the 1st rectangle to be painted. LEFT_1: [15:0]:- x-coordinate, ranging from -8192 to 8191. Bits 14 and 15 should be copies of bit 13. TOP_1: [31:16]:- y-coordinate, ranging from -8192 to 8191. Bits 30 and 31 should be copies of bit 29.
2	[BOTM_1 RITE_1]	The coordinates of the bottom-right corner of the 1st rectangle to be painted. RITE_1: [15:0]:- x-coordinate, ranging from -8192 to 8191. Bits 14 and 15 should be copies of bit 13. BOTM_1: [31:16]:- y-coordinate, ranging from -8192 to 8191. Bits 30 and 31 should be copies of bit 29.
...		
2n-1	[TOP_n LEFT_n]	The coordinates of the top-left corner of the n-th rectangle to be painted.
2n	[BOTM_n RITE_n]	The coordinates of the bottom-right corner of the n-th rectangle to be painted.

5.2.2.3 HOSTDATA_BLT
Functionality

Copy a number of bit-packed bitmaps to the video memory. It can be used to print a string of large characters on the screen. In other words, the function supports the LARGE BITGLYPH structure of Windows95 DDK.

Format

Ordinal	Field Name
1	[HEADER]
2	{SETTINGS}
3	{DATA_BLOCK}

DATA_BLOCK

Ordinal	Field Name	Description
1	[FRGD_COLOUR]	Foreground colour in the RGBQUAD format. For mono-to colour expansion only. The field is ineffective if field SRC_TYPE at SETTINGS.GUI_CONTROL is set to a type other than mono opaque or mono transparent (0 or 1).
2	[BKGD_COLOUR]	Background colour in the RGBQUAD format. For mono-to colour expansion only. The field is ineffective if field SRC_TYPE at SETTINGS.GUI_CONTROL is set to a type other than mono opaque or mono transparent (0 or 1).
3	{BIGCHAR_1}	Data block of the 1st character.
...		
m+2	{BIGCHAR_m}	Data block of the m-th character.

- **DATA_BLOCK.BIGCHAR_x**

Ordinal	Field Name	Description
1	[BaseY BaseX]	The coordinate of the top-left corner of the character's bitmap.

		BaseX: [15:0] :- x-coordinate. BaseY: [31:16] :- y-coordinate.
2	[HEIGHT WIDTH]	The geometry of the bitmap. WIDTH: [15:0] :- width of the bitmap. HEIGHT: [31:16] :- height of the bitmap.
3	[NUMBER[13:0]]	The number of DWORDs in the bitmap. It should be m in this case. The max value is 0x3FFF.
4	[RASTER_1]	The 1st DWORD of the mono bitmap data.
...		
m+3	[RASTER_m]	The m-th DWORD of the mono bitmap data.

5.2.2.4 POLYLINE

Functionality

Draw a polyline specified by a set of coordinates (x_0, y_0) , (x_1, y_1) , ..., (x_n, y_n) , where coordinate (x_0, y_0) is the beginning of the polyline, and coordinate (x_n, y_n) is the end.

Format

Ordinal	Field Name
1	[HEADER]
2	{SETTINGS}
3	{DATA_BLOCK}

DATA_BLOCK

Ordinal	Field Name	Description
1	[Y0 X0]	The starting coordinate of the polyline. X0: [15:0] :- x-component of the coordinate. Y0: [31:16] :- y-component.
2	[Y1 X1]	The 2nd coordinate of the polyline. Definition of bits is the same as above.
...		
n+1	[Yn Xn]	The ending coordinate of the polyline. Definition of bits is the same as above.

5.2.2.5 POLYSCANLINES

Functionality

Draw a number of scanlines and polyscanlines. The number can be one. The difference between a scanline and a polyscanline is that a scanline has only one starting x-coordinate and one ending x-coordinate while a polyscanline has a number of starting-ending x-coordinate pairs.

Format

Ordinal	Field Name
1	[HEADER]
2	{SETTINGS}

3	{DATA_BLOCK}
---	--------------

DATA_BLOCK

Ordinal	Field Name	Description
1	[SCAN_COUNT]	The number of scan subpackets identified by SCAN_x, where x denotes the ordinal number of a SCAN subpacket.
2	{ SCAN_1 }	The 1st scanline/polyscanline.
...		
n+1	{ SCAN_n }	The n-th scanline/polyscanline.

• **DATA_BLOCK.SCAN_x**

Ordinal	Field Name	Description
1	[NUM_LINE[13:0]]	The number of line segments in a polyscanline. Maximum is 0x3fff.
2	[HEIGHT TOP]	TOP: [15:0] :- y-coordinate of the polyscanline. HEIGHT: [31:16] :- The thickness of the line measured in pixels.
3	[END_1 START_1]	START_1: [15:0] :- the starting x-coordinate of the 1st line segment. END_1: [31:16] :- the ending x-coordinate of the 1st line segment.
...		
n+2	[END_n START_n]	START_n: [15:0] :- the starting x-coordinate of the n-th line segment. END_n: [31:16] :- the ending x-coordinate of the n-th line segment.

5.2.2.6 NEXTCHAR

Functionality

Print a character at a given screen location using the default foreground and background colours.

Format

Ordinal	Field Name
1	[HEADER]
2	{DATA_BLOCK}

DATA_BLOCK

Ordinal	Field Name	Description
1	[DST_Y DST_X]	The coordinates of the top-left corner of the destination bitmap. DST_X: [15:0] :- x-coordinate, ranging from -8192 to 8191. Bits 14 and 15 should be copies of bit 13. DST_Y: [31:16] :- y-coordinate, ranging from -8192 to 8191. Bits 30 and 31 should be copies of bit 29.
2	[DST_H DST_W]	The width and height of the destination bitmap, expressed in unsigned integers. DST_W: [15:0] :- width. DST_H [31:16] :- height.
3	[BITMAP_DATA_1]	The 1st DWORD of the bitmap data.
...		

N+2	[BITMAP_DATA_n]	The n-th DWORD of the bitmap data.
-----	-----------------	------------------------------------

5.2.2.7 PAINT_MULTI

Functionality

Paint a number of rectangles on the screen with one colour. The colour used is specified in field SETTINGS while the location and geometry of the rectangles are specified in field DATA_BLOCK.

Format

Ordinal	Field Name
1	[HEADER]
2	{SETTINGS}
3	{DATA_BLOCK}

DATA_BLOCK

Ordinal	Field Name	Description
1	[DST_X1 DST_Y1]	The coordinates of the top-left corner of the 1st rectangle. DST_Y1: [15:0]:- y-coordinate, ranging from -8192 to 8191. Bits 14 and 15 should be copies of bit 13. DST_X1: [31:16]:- x-coordinate, ranging from -8192 to 8191. Bits 30 and 31 should be copies of bit 29.
2	[DST_W1 DST_H1]	The width and height of the 1st rectangle, expressed in unsigned integers. DST_H1: [15:0]:- height. DST_W1: [31:16]:- width.
...		
2n-1	[DST_Xn DST_Yn]	The coordinates of the top-left corner of the n-th rectangle. DST_Yn: [15:0]:- y-coordinate, ranging from -8192 to 8191. Bits 14 and 15 should be copies of bit 13. DST_Xn: [31:16]:- x-coordinate, ranging from -8192 to 8191. Bits 30 and 31 should be copies of bit 29.
2n	[DST_Wn DST_Hn]	The width and height of the n-th rectangle, expressed in unsigned integers. DST_Hn: [15:0]:- height. DST_Wn: [31:16]:- width.

5.2.2.8 BITBLT

Functionality

Copy a source rectangle to a destination rectangle of the screen. It is assumed that the geometry of the destination is identical to its source.

Format

Ordinal	Field Name
1	[HEADER]
2	{SETTINGS}

3	{DATA_BLOCK}
---	--------------

DATA_BLOCK

Ordinal	Field Name	Description
1	[SRC_X1 SRC_Y1]	The coordinates of the top-left corner of the 1st source bitmap. SRC_Y1: [15:0]:- y-coordinate, ranging from -8192 to 8191. Bits 14 and 15 should be copies of bit 13. SRC_X1: [31:16]:- x-coordinate, ranging from -8192 to 8191. Bits 30 and 31 should be copies of bit 29.
2	[DST_X1 DST_Y1]	The coordinates of the top-left corner of the 1st destination. The definition of bits is the same as SRC_X1 and SRC_Y1.
3	[SRC_W1 SRC_H1]	The width and height of the 1st source bitmap, expressed in unsigned integers. SRC_H1: [13:0]:- height. SRC_W1: [29:16]:- width.

5.2.2.9 BITBLT_MULTI**Functionality**

Copy a number of source rectangles to destination rectangles of the screen respectively. It is assumed that the geometry of the destination is identical to its source.

Format

Ordinal	Field Name
1	[HEADER]
2	{SETTINGS}
3	{DATA_BLOCK}

DATA_BLOCK

Ordinal	Field Name	Description
1	[SRC_X1 SRC_Y1]	The coordinates of the top-left corner of the 1st source bitmap. SRC_Y1: [15:0]:- y-coordinate, ranging from -8192 to 8191. Bits 14 and 15 should be copies of bit 13. SRC_X1: [31:16]:- x-coordinate, ranging from -8192 to 8191. Bits 30 and 31 should be copies of bit 29.
2	[DST_X1 DST_Y1]	The coordinates of the top-left corner of the 1st destination. The definition of bits is the same as SRC_X1 and SRC_Y1.
3	[SRC_W1 SRC_H1]	The width and height of the 1st source bitmap, expressed in unsigned integers. SRC_H1: [13:0]:- height. SRC_W1: [29:16]:- width.
...		

3n-1	[SRC_Xn SRC_Yn]	The coordinates of the top-left corner of the n-th source bitmap. SRC_Yn: [15:0]:- y-coordinate, ranging from -8192 to 8191. Bits 14 and 15 should be copies of bit 13. SRC_Xn: [31:16]:- x-coordinate, ranging from -8192 to 8191. Bits 30 and 31 should be copies of bit 29.
3n-2	[DST_Xn DST_Yn]	The coordinates of the top-left corner of the n-th destination. The definition of bits is the same as SRC_Xn and SRC_Yn.
3n	[SRC_Wn SRC_Hn]	The width and height of the n-th source bitmap, expressed in unsigned integers. SRC_Hn: [13:0]:- height. SRC_Wn: [29:16]:- width.

5.2.2.10 TRANS_BITBLT

Functionality

Copy pixels from the source rectangle to the destination with transparency.

Format

Ordinal	Field Name
1	[HEADER]
2	{SETTINGS}
3	{DATA_BLOCK}

DATA_BLOCK

Ordinal	Field Name	Description
1	[CLR_CMP_CNTL]	This field decides how the transparent blitting is done. See following for details.
2	[SRC_REF_CLR]	Source reference colour in the RGBQUAD format. This is the colour to be stripped off from the source.
3	[DST_REF_CLR]	Destination reference colour in the RGBQUAD format. This is the colour to be preserved at the destination.
4	[SRC_X1 SRC_Y1]	The coordinates of the top-left corner of the 1st source bitmap. SRC_Y1: [15:0]:- y-coordinate, ranging from -8192 to 8191. Bits 14 and 15 should be copies of bit 13. SRC_X1: [31:16]:- x-coordinate, ranging from -8192 to 8191. Bits 30 and 31 should be copies of bit 29.
5	[DST_X1 DST_Y1]	The coordinates of the top-left corner of the 1st destination. The definition of bits is the same as SRC_X1 and SRC_Y1.
6	[SRC_W1 SRC_H1]	The width and height of the 1st source bitmap, expressed in unsigned integers. SRC_H1: [13:0]:- height. SRC_W1: [29:16]:- width.

- **DATA_BLOCK.CLR_CMP_CNTL**

This field controls how the source pixels are written to the destination, depending on the source and destination reference colours and comparison settings. The source pixels may be filtered against the source reference colour, and the destination pixels with a specific colour may be preserved according to field CLR_CMP_DST.

Bit(s)	Bit-Field Name	Description
2:0	CLR_CMP_SRC	Strip off the source reference colour from the source pixels.

		0 :- Do not strip off source pixels. All source pixels are written to the destination. 1 :- Block the blitting source. No source pixel is written to the destination. 2, 3 :- reserved. 4 :- The source pixels whose colour is equal to the reference colour are written to the destination. 5 :- The source pixels whose colour is NOT equal to the reference colour are written to the destination. 6 :- Reserved. 7 :- The source pixels whose colour is equal to the reference colour will be XORed with the foreground colour of a mono bitmap, and then written to the destination. That is, destPixel = srcPixel XOR foregrndColor if srcPixel is equal to the foreground colour of a mono bitmap, specifically text. This is referred to as flipping sometimes.
7:3	Reserved	
10:8	CLR_CMP_DST	Preserve pixels at the destination. 0 :- Do not preserve the destination pixels. All pixels from the source are written to the destination. 1 :- Preserve all the destination pixels. No source pixel is written to the destination. 2, 3 :- Reserved. 4 :- The destination pixels whose colour is equal to the reference colour are preserved. No source pixel is written on top of the pixels. 5 :- The destination pixels whose colour is NOT equal to the reference colour are preserved. 6, 7 :- Reserved.
23:11	Reserved	
25:24	CMP_ENABLE	The bits controls what type of operation to be carried out. 0 :- Enable function CLR_CMP_DST. 1 :- Enable function CLR_CMP_SRC 2 :- Enable both CLR_CMP_SRC and CLR_CMP_DST. The final decision is based on the agreement between decisions made separately. 3 :- Reserved.
31:26	Reserved	

5.2.2.11 PLY_NEXTSCAN

Functionality

Draw a number of scanlines or polyscanlines using the current settings.

Format

Ordinal	Field Name	Description
1	[HEADER]	The packet header
2	[HEIGHT TOP]	TOP: [15:0] :- y-coordinate of the scanline/polyscanline. HEIGHT: [31:16] :- The thickness of the line measured in pixels.
3	[END_1 START_1]	START_1: [15:0] :- the starting x-coordinate of the 1st dash. END_1: [31:16]:- the ending x-coordinate of the 1st dash.
...		
n+2	[END_n START_n]	START_n: [15:0] :- the starting x-coordinate of the 1st dash. END_n: [31:16]:- the ending x-coordinate of the 1st dash.

5.2.2.12 LOAD_PALETTE

Functionality

Set up the 3D engine scaler and load a palette for a consequent 2D scaling operation.

Format

Ordinal	Field Name	Description
1	[HEADER]	The packet header
2	[SCALE_DATATYPE]	1:- The palette has 16 entries (4 bpp palette). 2:- The palette has 256 entries (8 bpp palette).
3	[COLOR_1]	The 1 st entry of the palette. Data is in destination format (i.e. ARGB8888, RGB565, RGB555,...)
4	[COLOR_2]	The 2 nd entry of the palette. Bits are defined as above.
...		
n+2	[COLOR_n]	The n-th entry of the palette. n = 16 (4bpp) or 256 (8bpp)

5.2.2.13 SET_SCISSORS

Functionality

Set the scissors to the given parameters.

Format

Ordinal	Field Name	Description
1	[HEADER]	The packet header
2	[TOP_LEFT]	[13:0] :- x-coordinate of the left edge of the clipping rectangle (in number of pixels). [29:16] :- y-coordinate of the top edge of the clipping rectangle (in number of scanlines).
3	[BOTTOM_RIGHT]	[13:0] :- x-coordinate of the right edge of the clipping rectangle (in number of pixels). [29:16] :- y-coordinate of the bottom edge of the clipping rectangle (in number of scanlines).

5.2.3 3D Packets

5.2.3.1 3D_DRAW_VBUF

Functionality

Draws a set of primitives using a vertex buffer(s) pointed to by state data.

Format

Ordinal	Field Name	Description
1	[HEADER]	Header of the packet
2	[VAP_VTX_FMT]	** Not Written to Hardware, Microcode Throws Away **
3	[VAP_VF_CNTL]	Primitive type and other control (See VAP_VF_CNTL register in register spec) Number of Vertices is bits: 31:16

5.2.3.2 3D_DRAW_IMMD

Functionality

Draws a set of primitives using vertices stored in packet.

Format

Ordinal	Field Name	Description
1	[HEADER]	Header of the packet
2	[VAP_VTX_FMT]	** Not Written to Hardware, Microcode Throws Away **
3	[VAP_VF_CNTL]	Primitive type and other control (See VAP_VF_CNTL register in register spec) Number of Vertices is bits: 31:16
4 to end	Vertex data	Up to 16,380 DWORDs of vertex data.

5.2.3.3 3D_DRAW_INDX

Functionality

Draws a set of primitives using a vertex buffer(s) pointed to by state data, index from indices in packet. Indices are either 16-bit or 32-bit.

Format

Ordinal	Field Name	Description
1	[HEADER]	Header of the packet
2	[VAP_VTX_FMT]	** Not Written to Hardware, Microcode Throws Away **
3	[VAP_VF_CNTL]	Primitive type and other control (See VAP_VF_CNTL register in register spec) Number of Vertices is bits: 31:16
4 to end	[indx16 #2 indx16 #1] or [indx32]	Up to or 32,760 16-bit indices or 16,380 32-bit indices to vertex data pointed to by state registers. The INDEX_SIZE field in the VAP_VF_CNTL register indicates whether the indices are 16-bit or 32-bit. See INDX_BUFFER packet for support of more indices.

5.2.3.4 3D_DRAW_VBUF_2

Functionality

Draws a set of primitives using a vertex buffer(s) pointed to by state data.

Format

Ordinal	Field Name	Description
1	[HEADER]	Header of the packet
2	[VAP_VF_CNTL]	Primitive type and other control (See VAP_VF_CNTL register in register spec) Number of Vertices is bits: 31:16

5.2.3.5 3D_DRAW_IMMD_2

Functionality

Draws a set of primitives using vertices stored in packet.

Format

Ordinal	Field Name	Description
1	[HEADER]	Header of the packet
2	[VAP_VF_CNTL]	Primitive type and other control (See VAP_VF_CNTL register in register spec) Number of Vertices is bits: 31:16
3 to end	Vertex data	Up to 16,381 DWORDs of vertex data

5.2.3.6 3D_DRAW_IND_2

Functionality

Draws a set of primitives using a vertex buffer(s) pointed to by state data, index from indices in packet.

Format

Ordinal	Field Name	Description
1	[HEADER]	Header of the packet
2	[VAP_VF_CNTL]	Primitive type and other control (See VAP_VF_CNTL register in register spec) Number of Vertices is bits: 31:16
3 to end	[indx16 #2 indx16 #1] or [indx32 #1]	Up to or 32762 16-bit indices or 16,381 32-bit indices to vertex data pointed to by state registers. The INDEX_SIZE field in the VAP_VF_CNTL register indicates whether the indices are 16-bit or 32-bit. See INDX_BUFFER packet for support of more indices.

5.2.3.7 3D_DRAW_128

Functionality

Draws a set of primitives using a vertex buffer(s) pointed to by state data, index from indices in packet. Data/Indices are written to 128-bit VAP vector data port to take advantage of the 128-bit data path for sending data. The packet should only be used in bus master mode.

Vector mode operates as follows:

1. Data will be written to the destination register (VAP_POR_DATA_IDX_128) one DWORD at a time until the source address of the data is aligned to a vector (128 bits).
2. Once aligned, the data will be written 128-bits per clock to the destination register. The CP does grouping of the data such that it will wait until a full vector is available if the MC is slow in returning the data that was requested.
3. If the last DWORDs of a packet do not fill a vector, they will still be written in one clock, but the DWORD write mask will be set accordingly.

Format

Ordinal	Field Name	Description
1	[HEADER]	Header of the packet
2	[VAP_VF_CNTL]	Primitive type and other control (See VAP_VF_CNTL register in register spec) Number of Vertices is bits: 31:16
3 to end	<i>Data or Indices</i>	See other 3D_DRAW packets for details.

5.2.3.8

5.2.3.9 3D_LOAD_VBPNTNTR

Functionality

Load the vertex arrays pointers.

Format

Ordinal	Field Name	Description
1	[HEADER]	Header of the packet
2	VTX_NUM_ARRAYS	Number of arrays
3	VTX_AOS_ATTR01	Control for the first two arrays
4	VTX_AOS_ADDR0	Pointer to first array
5	VTX_AOS_ADDR1	Pointer to second array
6	VTX_AOS_ATTR23	And so on....
7	VTX_AOS_ADDR2	
8	VTX_AOS_ADDR3	
9	VTX_AOS_ATTR45	
10	VTX_AOS_ADDR4	
11	VTX_AOS_ADDR5	
12	VTX_AOS_ATTR67	
13	VTX_AOS_ADDR6	
14	VTX_AOS_ADDR7	
15	VTX_AOS_ATTR89	
16	VTX_AOS_ADDR8	
17	VTX_AOS_ADDR9	
18	VTX_AOS_ATTR1011	
19	VTX_AOS_ADDR10	
20	VTX_AOS_ADDR11	

5.2.3.10 3D_CLEAR_HIZ

Functionality

Clear HIZ RAM.

Format

Ordinal	Field Name	Description
1	[HEADER]	Header of the packet
2	START	Start
3	COUNT[13:0]	Count[13:0] – Maximum is 0x3FFF.
4	CLEAR_VALUE	The value to write into the HIZ RAM.

5.2.3.11 INDX_BUFFER

Functionality

Initiates Indirect Buffer #2 (IB #2) to fetch data that is written to the destination address. The main reason for this packet is to fetch indices from an index buffer. The packet however can be used to fetch any type of data and write it to destination address(s) in the chip.

To process an index buffer, first issue a 3D_DRAW_INDX packet with only the VAP_VTX_FMT and VAP_VF_CNTL DWORDs (i.e. count = 1). Then process an INDX_BUFFER packet to supply the indices that would have otherwise been in the 3D_DRAW_INDX packet. Note: For a 3D_DRAW_INDX_2 packet, the VAP_VTX_FMT is not present and the count in the header should be zero.

The maximum size of the Indirect #2 Buffer is 8,192K DWORDs – as determined by the BUFFER_SIZE field. So the maximum number of indices supported is 8,192K 32-bit or 16,384K 16-bit indices. These maximums may be further limited by the design of the Vertex Fetcher/Vertex Cache. See the VAP specification for details.

Format

Ordinal	Field Name	Description
1	[HEADER]	Header of the packet
2	[ONE_REG_WR SKIP_COUNT DESTINATION]	ONE_REG_WR – Bit 31 (Set for upper-word-aligned buffers) SKIP_COUNT – Bits 18:16: Number of DWORDs to discard at start of data buffer DESTINATION Address – Bits 12:0
3	BUFFER_BASE[31:2]	Base Address of Buffer – Written to CP_IB2_BASE
4	BUFFER_SIZE[22:0]	Size of Buffer in DWORDs – Written to CP_IB2_BUFSZ to initiate the Indirect Buffer #2. Note that the (BUFFER_SIZE – 1) also overwrites the CNT register in the micro engine so that the parser will not finish with this packet until all the data from the IB #2 is transferred. <u>For misaligned data, this number must be increased by 1.</u>

5.2.3.12 MPEG_INDEX

Functionality

Packed register writes for MPEG and Generation of Indices.

Format

Ordinal	Field Name	Description
1	[HEADER]	Header field of the packet.
2	[MASK]	DWORD write Mask: Bits 15:0 are “present” bits to indicate whether to write the register: bit[0] VAP_PVS_CODE_CNTL_0 present bit[1] VAP_PVS_CODE_CNTL_1 present bit[2] VAP_PROG_STREAM_CNTL_0 present bit[3] VAP_PROG_STREAM_CNTL_1 present bit[4] VAP_PROG_STREAM_CNTL_2 present bit[5] VAP_PROG_STREAM_CNTL_3 present bit[6] VAP_OUT_VTX_FMT_0 present bit[7] VAP_OUT_VTX_FMT_1 present bit[8] VAP_VTX_NUM_ARRAYS present bit[9] RS_COUNT present bit[10] RS_INST_COUNT present bit[11] TX_ENABLE present bit[12] US_CODE_ADDR_0 present bit[13] US_CODE_ADDR_1 present bit[14] US_CODE_ADDR_2 present bit[15] US_CODE_ADDR_3 present bit[16] US_CONFIG present bit[17] RB3D_DSTCACHE_CTLSTAT present bit[18] RB3D_COLOROFFSET0 present bit[19] RB3D_COLORPITCH0 present
Conditional	[Register Values]	Values to Write into Registers. Only present in packet if corresponding

3 up to 22		“present” bit is set in the MASK.
Next	[VF_CNTL]	Written Unconditional to VAP_VF_CNTL register
Next+1	[NUM_INDICES]	Number of Index Base Values (0x3FFF Maximum)
Next+2 to Next+2+ NUM_INDICES	[FIRST_INDEX]	First Index of Quad. (0x0000 to 0xFFFC) For each “First Index”, CP will generate the other 3 indices and output: FIRST_INDEX FIRST_INDEX+1 FIRST_INDEX+2 FIRST_INDEX+3
Last Values	[DUMMY]	Any value is fine. Any number of dummy values are supported.

5.2.4 PRED_EXEC

Functionality

Perform a predicated execution of a sequence of packets (type 0, 2, and type 3) on select devices.

Format

Ordinal	Field Name	Description
1	[HEADER]	Header field of the packet.
2	[DEVICE_SELECT EXEC_COUNT]	DEVICE_SELECT: [31:24] – bitfield to select one or more device upon which the subsequent predicated packets will be executed EXEC_COUNT: [22:0] – total number of DWORDs of subsequent predicated packets. This count wraps the packets that will be predicated by the device select.

5.2.4.1 WAIT_SEMAPHORE

Functionality

Wait for a semaphore to be zero before continuing to process the subsequent command stream. There are four microcode ram slots set aside for use as semaphores. These are at offset 0xFC-0xFF.

Notes

The driver/application executing on the CPU can write non-zero values at any time to semaphore memory. The application can write a non-zero value to cause the CP micro-engine to pause at the next WAIT_SEMAPHORE packet in the command stream. This has the affect of pausing all GPU rendering that is queued in the indirect and ring buffers. The application can then write a zero to the semaphore to allow the micro-engine to proceed.

The application can write to the semaphore memory by a direct (PIO) register write to two registers:

1. Write the semaphore offset (0xFC, 0xFD, 0xFE, or 0xFF) to the CP_ME_RAM_ADDR register.
2. Write the semaphore value (zero or non-zero) to the CP_ME_RAM_DATA register.

Format

Ordinal	Field Name	Description
1	[HEADER]	Header field of the packet.
2	Semaphore offset	This is the desired semaphore to test in the wait loop. This can be any one of 0xFC, 0xFD, 0xFE, 0xFF.
3	Semaphore reset	Optional. This value, if present, is written to the semaphore offset once the wait loop has been satisfied (i.e., once the semaphore is zero).

5.2.5 Miscellaneous Packets

5.2.5.1 COND_EXEC

Functionality

Perform a conditional execution of a sequence of packets (type 0, 2, and type 3) based on a boolean stored in GPU-accessible video memory.

This packet use the Indirect Buffer #2 (IB2) to read the boolean in memory. Therefore, this packet can not be initiated from an IB2.

Notes

Care must be taken to make certain that EXEC_COUNT contains the exact number of DWORDs for the subsequent packets that are to be conditionally executed. The microengine will start parsing the DWORD immediately following EXEC_COUNT DWORDs. If this is not a packet header, the device will encounter corruption or hang.

Format

Ordinal	Field Name	Description
1	[HEADER]	Header field of the packet.
2	TWO	<i>This value must be 2</i>
3	EXEC_COUNT	EXEC_COUNT: [22:0] – total number of DWORDs of subsequent conditional packets. This count wraps the packets that will be conditionally executed.

5.2.5.2 WAIT_MEM

Functionality

Wait for a GPU-accessible memory semaphore to be zero before continuing to process the subsequent command stream. The semaphore can reside in any GPU-accessible memory (local or non-local). The base address of the semaphore must be aligned to a DWORD boundary. The semaphore in memory consists of two DWORDs.

This packet has no ability to increment, decrement or otherwise change the contents of the memory semaphore.

The memory semaphore consists of two DWORDs: the actual semaphore and an extra DWORD with a fixed value of two. The extra DWORD is required and guarantees that the command processor micro-engine can loop properly in order to repeatedly test the semaphore value as necessary. The semaphore is organized as follows:

Semaphore value
Fixed value of 2

This packet use the Indirect Buffer #2 (IB2) to read the memory semaphore. Therefore, this packet can not be initiated from an IB2.

Notes

If both ordinal 3 (SEM_LEN) and the DWORD in memory following the semaphore value is not equal to two, the CP micro-engine will become confused and ultimately hang the hardware.

The driver/application executing on the CPU can write non-zero values at any time to semaphore memory. The application can write a non-zero value to cause the CP micro-engine to pause at the next WAIT_MEM packet in the

command stream. This has the affect of pausing all GPU rendering that is queued in the indirect and ring buffers. The application can then write a zero to the semaphore to allow the micro-engine to proceed.

Format

Ordinal	Field Name	Description
1	[HEADER]	Header field of the packet.
2	SEM_ADDR[31:2]	Memory semaphore device address (DWORD aligned) This value is written to the CP_IB2_BASE in order to read the semaphore
3	SEM_LEN	Memory semaphore length <i>This value MUST be 2</i> This value is written to the CP_IB2_BUFSIZ in order to read the semaphore the first time

6. Vertex Shaders

6.1 Introduction

The VAP includes the Vertex Fetcher and Vertex Cache which take commands and vertex data from a command stream and formats it into vertices and primitives. Typically, the commands are stored in a ring buffer and the vertex data is stored as a separate array in memory, although there are other possibilities described later. The VAP begins operation when a command to render a set of primitives is received. Depending on the command, the VAP will either expect vertex data to be sent, or it will perform the memory accesses to read the vertex data on its own. The format of the vertex data is described later in this section.

The VAP includes a Programmable Vertex Shader (PVS) Engine which performs programmable operations on vertices which are then subsequently assembled and clipped. This programmable processing path will also be used to perform all Fixed-Function vertex processing after driver generation of a shader from fixed-function state settings.

The VAP includes a Clip Engine which will clip primitives (using the PVS-processed vertices) to the 6 frustum planes as well as to 6 User-Defined Clip Planes. The VAP includes a Viewport Transform Engine (VTE) which performs the perspective divide and viewport transformation operations on the vertex data and a Reciprocal Engine (RCP) which performs an IEEE 23-bit mantissa accurate $1/X$ function.

6.2 Input

The input to the VAP is a *Command Packet* which contains two parts: a command to render some set of primitives (like a list of triangles), and a set of vertex data. As described later, the vertex data may be sent to the VAP or the Vertex Fetcher may fetch the data. There are a number of different data formats which are possible. Data may be stored as an array of structures (AOS), a structure of arrays (SOA), or in a strided vertex format. The AOS mode is what has been used up to DX6. In AOS mode, all of the data for a vertex is stored sequentially as one contiguous block of memory as shown in Figure. In SOA mode, the data for each parameter (like x or w) is stored as a separate array. To get all of the data for a vertex, one must look into several different arrays. For example, assume that we have eight vertices which have the parameters X, Y, W, S, and T. In SOA mode the data would be stored in five different arrays as shown in Figure. In the strided vertex format, data is stored in several different arrays. Each array holds a variable number of parameters. For example, the first array might hold the x, y, and z coordinates. A second array might hold the diffuse color, a third array might hold the S and T coordinates for a texture map. Figure shows how a strided vertex with x, y, z, w, S, and T might be stored. The holes in the xyz array are not required but are shown to indicate the flexibility allowed with the strided vertex format.

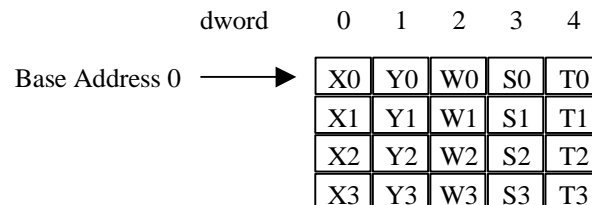

Figure: AOS Vertex Data Storage

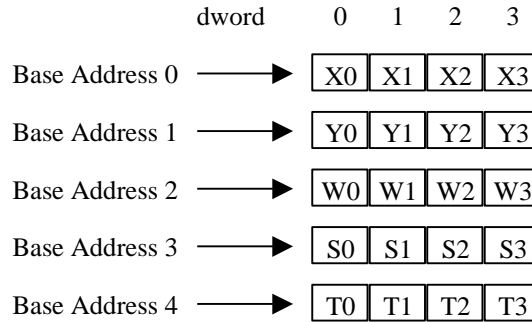

Figure: SOA Vertex Data Storage

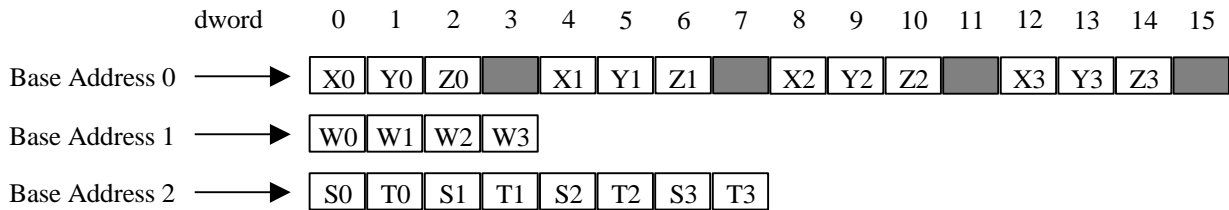

Figure: Strided Vertex Data Storage

To represent all of these formats, the Vertex Fetcher architecture allows for a vertex to be described as *multiple arrays of structures*. Each array is described with a *base address*, a *count* and a *stride*. The base address points to the beginning of the array. The count indicates the number of dwords of vertex data in this array. The stride gives the number of dwords to the next structure in the array of structures. The AOS vertex from Figure with 5 parameters would be represented with a single array which consists of 5 dwords with a stride of 5 dwords. The SOA vertex from Figure would be represented with 5 arrays. Each array would have a count of 1 and a stride of 1. The strided vertex from Figure would be represented with three arrays. The first array would have a count of 3 and a stride of 4. The second array would have a count of 1 and a stride of 1. The third array would have a count of 2 and a stride of 2. A given implementation of this architecture may have a different maximum number of arrays of structures. If only AOS is supported, then only one array is required. To support a strided vertex format with three textures, 7 arrays would be required (xyz, w, diffuse, specular, S0T0, S1T1, S2T2.) To support a true SOA mode, each parameter would require its own array.

The access to vertex data may be immediate or by an index. In immediate mode, the base address of an array of vertex data is provided. The vertex data should be read in the order in which it is stored to produce the desired primitives. In indexed mode, a base address to the beginning of the vertex data is provided along with a set of indices. The indices are used to access vertices in any order.

The vertex indices are clamped between a minimum and maximum state value which is supplied by the driver. This prevents making requests to illegal or unavailable memory addresses.

Finally, the vertex data can be embedded as part of the command stream, or it can be stored in a separate array. The figure below shows all of the possible vertex data storage modes along with implementation details for each mode.

The table below describes the parameters that may be in a vertex, as supplied to the graphics controller device.

NOTE: With the R300 PVS-only vertex processing path and PSC-only input vertex data mapping path, the TCL (or PVS) input memories have no pre-defined mapping to vertex values. This is completely determined by the driver FF->PVS conversion process. Due to this fact, the table below is fairly meaningless to the vertex process. It is retained as a guide to help describe the fixed-function possibilities for vertex data.

Type	Parameter	Description	Format	Applicable Interface (PRE-TNL / POST-TNL / BOTH)**
Position0 XY	X0	The x coordinate of the vertex	IEEE floating point	BOTH
	Y0	The y coordinate of the vertex	IEEE floating point	BOTH
Position0 Z	Z0	The z coordinate of the vertex	IEEE floating point	BOTH
Position0 W	W0	W or RHW (1/Homog W) coordinate of the vertex	IEEE floating point	BOTH
Vertex Blending Weight(s)	BW0-4	0-4 Blend Weights	IEEE floating point	PRE-TNL
Per-Vertex Matrix Select	PVMS	Vertex Blending Matrix Selects	8888 packed fixed point	PRE-TNL
Vertex Normal 0	Nx0	The x coordinate of the vertex normal	IEEE floating point	PRE-TNL
	Ny0	The y coordinate of the vertex normal	IEEE floating point	PRE-TNL
	Nz0	The z coordinate of the vertex normal	IEEE floating point	PRE-TNL
Point Size Modifier	PS	Point Size Modifier – Point Sprites – Post-TCL only	IEEE floating point	BOTH
Discrete Fog	F	Fog value – Post TCL only	IEEE floating point	POST-TNL
Shininess0	Shine0	Used for GL Material Per-Vertex Support	IEEE floating point	PRE-TNL
Shininess1	Shine1	Used for GL Material Per-Vertex Support	IEEE floating point	PRE-TNL
Color 0	ARGB	Typically Diffuse color and alpha weight	Usually 8888, but can be three or four separate IEEE floating point values **	BOTH

Color 1	ARGB	Typically Specular color and fog/alpha weight	Usually 8888, but can be three or four separate IEEE floating point values **	BOTH
Color 2	ARGB	Typically Used for GL Material Per-Vertex Support	Usually 8888, but can be three or four separate IEEE floating point values **	PRE-TNL
Color 3	ARGB	Typically Used for GL Material Per-Vertex Support	Usually 8888, but can be three or four separate IEEE floating point values **	PRE-TNL
Color 4	ARGB	Typically Used for GL Material Per-Vertex Support	Usually 8888, but can be three or four separate IEEE floating point values **	PRE-TNL
Color 5	ARGB	Typically Used for GL Material Per-Vertex Support	Usually 8888, but can be three or four separate IEEE floating point values **	PRE-TNL
Color 6	ARGB	Typically Used for GL Material Per-Vertex Support	Usually 8888, but can be three or four separate IEEE floating point values **	PRE-TNL
Color 7	ARGB	Typically Used for GL Material Per-Vertex Support	Usually 8888, but can be three or four separate IEEE floating point values **	PRE-TNL
Texture Coordinate Set 0	S0	The 1st coordinate for texture number 0 (usually the single dimension horizontal component S)	IEEE floating point	BOTH
	T0	The 2nd coordinate for texture number 0 (usually the two dimension vertical component T)	IEEE floating point	BOTH
	R0	The 3rd coordinate for texture number 0 (The 3 rd & 4 th components can have many uses)*	IEEE floating point	BOTH
	Q0	The 4th coordinate for texture number 0 (The 3 rd & 4 th components can have many uses)*	IEEE floating point	BOTH
Texture Coordinate	S1	The 1st coordinate for texture number 1	IEEE floating point	BOTH

Set 1		(usually the single dimension horizontal component S)		
	T1	The 2nd coordinate for texture number 1 (usually the two dimension vertical component T)	IEEE floating point	BOTH
	R1	The 3rd coordinate for texture number 1 (The 3 rd & 4 th components can have many uses)*	IEEE floating point	BOTH
	Q1	The 4th coordinate for texture number 1 (The 3 rd & 4 th components can have many uses)*	IEEE floating point	BOTH
.
.
.
Texture Coordinate Set 5	S5	The 1st coordinate for texture number 5 (usually the single dimension horizontal component S)	IEEE floating point	BOTH
	T5	The 2nd coordinate for texture number 5 (usually the two dimension vertical component T)	IEEE floating point	BOTH
	R5	The 3rd coordinate for texture number 5 (The 3 rd & 4 th components can have many uses)*	IEEE floating point	BOTH
	Q5	The 4th coordinate for texture number 5 (The 3 rd & 4 th components can have many uses)*	IEEE floating point	BOTH
Position1 XY	X1	The x coordinate of the vertex for blending	IEEE floating point	PRE-TNL
	Y1	The y coordinate of the vertex for blending	IEEE floating point	PRE-TNL
Position1 Z	Z1	The z coordinate of the vertex for blending	IEEE floating point	PRE-TNL

Position1 W	W1	W or RHW (1/Homog W) coordinate of the vertex for blending	IEEE floating point	PRE-TNL
Vertex Normal 1	Nx1	The x coordinate of the vertex normal	IEEE floating point	PRE-TNL
	Ny1	The y coordinate of the vertex normal	IEEE floating point	PRE-TNL
	Nz1	The z coordinate of the vertex normal	IEEE floating point	PRE-TNL

Figure: Vertex Parameters

** The Applicable Interface column is provided to specify which values are inputs to the TCL process and/or the Raster Process. All of the values can appear in the FVF at the same time, but PRE-TNL values are ignored by the raster process and POST-TNL values are ignored by the TCL process. In the unlikely circumstance that POST-TNL values are provided in the FVF as inputs to the TCL process, there will be the ability to pass these values around the TCL process.

6.3 Vector Order and Vector ID's

With the move to a PSC-only and PVS-only Vertex Process, there is no fixed definition of data (or location of data) in the input vertex memory. Therefore, the destination vector locations in the PSC are fully flexible and map directly into the corresponding location in the input vertex memory. The PSC also allows for write_mask and swizzle capabilities to allow for more complex fixed-function and/or shader usage.

The special vector known as the NULL vector is used to keep the pipeline flow the same when there are no vectors to be processed. It is a sort-of "special" vector that each engine knows to ignore it as far as processing is concerned, but it is used because we need to send some kind of token down the pipeline for synchronization purposes.

The NULL vector is a vector that is not to undergo vector processing, but which will carry information in its associated flags, such as endOfPacket. It is used when a vertex has been deleted (for culling, clipping, or other potential reasons) and there is no valid vertex to be sent with the control information.

For the case of TCL_BYPASS (or when there is no TCL present in the HW), the PSC destination vector locations shall map directly to the semantically defined locations of the GA input memories. In this mode, the discrete fog and point size terms can use the write_enable and or swizzle capabilities of PSC to get the terms into the appropriate channels.

6.4 VAP Registers

6.4.1 VAP Vertex Data Port Registers

The DATA and IDX PORT registers are written with either primitive vertex data or primitive vertex indices after a “trigger” write has occurred. A “trigger” write is a write to the VAP_VF_CNTL register with a non-zero prim_type.

The correct (expected) number of data words or index words must be written to these registers or undefined behavior will result.

For R300, there is a new DATA/IDX port register added for 128-bit access. This register is only accessible via a PM4 Type3 packet and can only be used for indexed TRI_LIST and LINE_LIST. Other than the prim-type limitations, using this 128-bit register (or PM4 Type 3 packet opcode) is identical to using the standard method.

The PRIM_WALK field in the VAP_VF_CNTL register defines what method of vertex data or indx updates are to occur.

1 = Indexes (Indices embedded in command stream; vertex data to be fetched from memory)

In this mode, vertex indices are written to the DATA/IDX port registers. Data is fetched using the AOS registers corresponding to the indices in the input list. The number of indices expected is $VAP_VF_CNTL.NUM_VERTICES - 1$. This mode does not use the VAP_VTX_SIZE register. The size of the vertices is determined by the AOS register setup.

2 = Vertex List (Vertex data to be fetched from memory)

This mode does not require any vertex data or vertex indices written to the DATA/IDX port registers. Data is fetched using the AOS registers for the indices from 0 to $VAP_VF_CNTL.NUM_VERTICES - 1$. Identical to Indexes mode, except indices are internally generated.

3 = Vertex Data (Vertex data embedded in command stream)

In this mode, the vertex data is written to the DATA port registers. The number of DWORDS expected is $VAP_VTX_SIZE.DWORDS_PER_VTX * (VAP_VF_CNTL.NUM_VERTICES - 1)$. **The VAP_VTX_SIZE register is new to R300.** In R100 / R200, this size was derived from the VAP_VTX_FMT_0/1.

6.4.2 VAP Control Register

The PVS_NUM_SLOTS should be set to the minimum of

- the MAX_SLOTS, (POR is 10)
- the $INPUT_VTX_MEM_SIZE / INPUT_VECTORS_PER_VTX$ (POR is 128 / Var)
- the $OUTPUT_VTX_MEM_SIZE / OUTPUT_VECTORS_PER_VTX$ (POR is 128 / Var)

These equations assume the input and output vertex data has been packed. If not, use the MAX_INPUT_VECTOR_USED instead of INPUT_VECTORS_PER_VTX

The PVS_NUM_CNTLRS should be set to the minimum of

- the MAX_CNTLRS, (POR is 6)
- the $TEMP_VTX_MEM_SIZE / TEMP_VECTORS_PER_VTX$ (POR is 128 / Var)

These equations assume the temp vertex data has been packed. If not, use the MAX_TEMP_VECTOR_USED instead of TEMP_VECTORS_PER_VTX.

When modifying either of PVS_NUM_SLOTS or PVS_NUM_CNTLRS, a flush must be inserted prior to the update.

The PVS_NUM_FPUS will typically remain constant for a given chip, but can be used for performance testing.

The Shader HW will support up to a max of 32 vectors-per-vertex of input data and 32-vectors-per-vertex of temp data as long as the NUM_SLOTS and NUM_CNTLRS are set to obey the above-described rules.

New R5xx Fields

The TCL_STATE_OPTIMIZATION bit enables a hardware optimization to improve small batch and multiple instance performance. The TCL_STATE_OPTIMIZATION is a bit which should be set all the time. The bit can be reset to return operation to pre-R5xx status.

6.4.3 R300 Edge Flag Support Description

Edge Flags refers to the bits which are provided, generated and/or modified during the primitive process which affect which edges (lines) or points of a triangle are drawn when in a wireframe or point fill mode. Edge Flags are not applicable to line or point primitive types, but are applicable to all 3 or more-sided primitives (i.e quad, polygon, etc). R300 will support edge flags for wireframe rendering as follows :

1. Prim Type initialization of edge flags is done by the vertex fetcher logic. Edge flags are initialized by the vertex fetcher based on the VAP_VF_CNTL.PRIM_TYPE field. The edge flags values for points and lines are not used during the triangle fill process, so are irrelevant. The edge flags for all triangle primitive types are all 3 set. For more complex prim types like quads and polygons, only the exterior of the primitive is supposed to be drawn, so the vertex fetcher applies the edge flags in a way which only sets the bits which correspond to an external edge of the supplied primitive.
2. Clipping modification of edge flags is done by the clipping processor according to the OpenGL specification. Basically, the rule is that edges introduced by clipping (which would lie along a clip plane) will always have their corresponding edge flag set and edges which are fragments of initial edges would retain their original edge flags. The boundary edges introduced by clipping may be either always set or never based on the VAP_CLIP_CNTL.BOUNDARY_EDGE_FLAG_ENA bit.

6.4.4 Input Vertex Format Registers

The VAP_VTX_FMT_0 and VAP_VTX_FMT_1 registers were used for 2 reasons on R200:

1. Decoding / Data Conversion / Data Direction of Vertex Stream Data from output of Cache to Vector ID's
2. Computation of Dwords/Vtx for Command Stream load of vertex data.

These registers will no longer exist for R300. They are replaced as follows:

- The Decoding / Data Conversion / Data Direction will be controlled completely by the Programmable Stream Control logic. R300 will contain the additional functionality of component swizzle and write-mask specification to ensure full control of input stream.
- The computation of Dwords/Vtx will be replaced by the VAP_VTX_SIZE register which must be loaded by the driver when using command stream vertex data.

6.4.5 TCL Output Vertex Format Registers

The purpose of these controls is to indicate which vertex data should be transmitted from the PVS output vertex

memories, and from which vector locations they come. The PVS output vertex memories are not directly mapped to semantic values to enable the split-vertex mode described later. The RASTER_VTX_FMT_0/1 registers define which values will be transmitted from PVS to CLIP/Setup to GA to Raster.

The locations of the vectors in the PVS output memory must be packed based on the VAP_OUT_VTX_FMT_0/1 register settings. Only the fields which are present in the OVFRs should be packed in the output memory. The packing order is as follows: Position is always in location 0, Point Size (if present) is next (Point Size consumes an entire vector in the memory, the X-channel is the value used by the raster), Colors (0-3) are next (if present), and Textures (0-7) are next (if present). For example if the OVFR specified POS, PNT_SIZE, C0, C2, T1 and T5, these vectors should be mapped (by the shader output operand offsets) to Output Memory locations 0-5 respectively.

For Points (Sprites) using Tex Gen (GB_ENABLE.TEX#_SOURCE == STUFF), the VAP_OUT_VTX_FMT_1.TEX# should not be set. This is because, in general, there is no texture coordinate data transferred from VAP to GA for this case. In the case of point clipping with tex gen, VAP will send these texture coordinates to the GA even though the OVFR bit is not set, as follows:

OVFR COUNT	STUFF TEX	DESIRED CHANGED RESULT
0	0	No texture ever
0	>0	Clipper and/or GA creates (stuffs) texture
>0	0	Normal texture (use vertex/pvs texture)
>0	>0	Normal texture (use vertex/pvs texture)

There is also the ability to pack 2 2-dimensional textures into a single 4-component texture for the VAP->GA interface by only specifying one texture and mapping the raster state to think it is two textures.

6.4.6 Vertex State Control

This vector controls how the per-vertex state is processed. This input method is designed for OpenGL Immediate Mode and Display List Processing.

UPDATE_USER_COLOR_0/1_ENA are deleted from R300 since they are not needed, only one user color is required.

The COLOR#_ASSEMBLY_CNTL change from 2-bit fields on R200 to 1-bit fields on R300 since there is only 1 USER COLOR.

6.4.7 Programmable Input Stream Control Registers

These registers control the post-vertex-cache mapping of input vertex stream data to the vector ids for TCL or SE input memories. These registers replace the R200 Input Vertex Format Registers. Terminology: A vertex is composed of multiple (up to 16 for R300) streams. A stream can be composed of multiple elements (where an element is pos or norm or texcoord). The control data is arranged as 16 sets of element control data. There is not necessarily a one-for-one mapping of stream to element. The stream control shall be set up in the order that the data is received (or fetched).

The DataType specifies the number of DWORDS and format for each input element.

The SkipDwords specifies the number of DWORDS to skip (discard from the input stream) after the corresponding

element has been processed. This allows multiple non-contiguous elements to reside within one stream. **NOTE: There is not support for skipping DWORDS prior to the first element, the assumption is that the driver can prevent this from occurring.**

There are two sets of PSC control registers, the VAP_PROG_STREAM_CNTL_0-7 are identical to the R200 registers of the same name. R300 adds VAP_PROG_STREAM_CNTL_EXT_0-7 which are extensions to the first set of registers to allow a swizzle and write_mask capability. The expectation is that the EXT registers will not be updated frequently, but **they must be updated at least once to provide default control.**

The DstVecLoc specifies the destination vector location (TCL / SE input vector address) for the given element.

The data type of FLOAT_8 has been added to R300 to permit using input vertices greater than 16 vectors. By making sure that the VAP_CNTL.PVS_NUM_SLOTS and VAP_CNTL.PVS_NUM_CNTLRS are appropriately sized, it is possible to use up to 32 vectors for the input vertex representation.

6.4.8 PVS State Flush Register

Since the driver is given control over multi-state updates to PVS Code and Constant memories, there is the need for the driver to be able to force a “flush” of the state data. When this register address is written, the State Block will force a flush of TCL processing so that both versions of TCL state are available before updates are processed. This register is write only, and the data that is written is unused.

6.4.9 PVS Vertex Timeout Register

A condition can occur in the HW, in pathological vertex reuse cases, where when many primitives are sent which do not use any new verts, the HW could hang. The solution for this hang is to wait a programmable number of clocks when in the condition of primitive buffer full and waiting on vertices. After this number of clocks has passed without receiving any new vertex data, the accumulated vertex data (less than 4 vertices) will be submitted to the PVS engines. This register defaults to 0xFFFFFFFF.

6.4.10 VECTOR Indx/Data Update Register Pair

The Vector Indx Data pair is used to update all TCL vector state memories.

There are basically 2 vector memories, the PVS Constant Memory and the PVS Code Memory.

The index register contains the octword offset to write to (or read from) on the subsequent DATA_REG write/read. All writes/reads must start octword aligned. An internal Dword counter is incremented each time a write or read occurs to/from the DATA_REG. The Dword counter is reset when the index register is written (or read). When the dword counter rolls from 3 back to 0, the index register value (octword address) is incremented. (Writes to the DATA_REG_128 register do not use or affect the dword counter. The DATA_REG_128 register is not readable.

The VAP_PVS_VECTOR_DATA_REG_128 register is very similar to the VAP_TCL_VECTOR_DATA_REG, but allows 128-bit writes into the vector memory. There may be some restrictions when writing to this register (i.e. only 128-bit aligned, 128-bit updates allowed).

The vertex shader instruction store increased from 256 to 1024 for R5xx VS3.0.

To account for the increased shader instruction store, the Offsets Used to get to the various memories (and elements of memories) are as follows:

```
#define VERTEX_SHADER_CONST_VECS 256
#define VERTEX_SHADER_CODE_LINES 1024 // R300 256

#define PVS_CODE_START 0
```

```

#define PVS_CONST_START          1024 // R300 512
#define UCP_START_OFFSET        1536 // R300 1024
#define POINT_VPORT_SCALE_OFFSET 1542 // R300 1030
#define POINT_GEN_TEX_OFFSET    1543 // R300 1031
    
```

6.4.11 State-Vector Engine State Data

The input vector state data required for TCL is listed in the table below. Each entry will consist of 4 single precision *IEEE* floating-point vector values. The entire StVe_Vector memory is accessed via an index/data register pair. When updating multiple DWORDS through this path, the PM4 packet bit which prevents auto-incrementation should be used so that all words are written to the data register.

UCP0	XYZW	User clip plane 0	4 IEEE fp
UCP1	XYZW	User clip plane 1	4 IEEE fp
:	:	:	
UCP5	XYZW	User clip plane 5	4 IEEE fp
Point Sprite Viewport Scale / Misc	XYZW	Viewport scaling parameters for Point Sprite Expansion in Clip Coords X = X-Radius Expansion Y = Y-Radius Expansion Z = State Size Multiply Constant W = Culling Radius Expansion (SQRT(XRadExp ^2 + YradExp ^2)	4 IEEEfp
Point Tex Gen Corner Values	XYZW	Texture values to apply to points when tex gen is on X = Lower Left Corner S-Value Y = Lower Left Corner T-Value Z = Upper Right Corner S-Value W = Upper Right Corner T-Value ** These values may be updated using the VAP_PVS_VECTOR_DATA_REG or via the GA_POINT_S0,T0,S1,T1 Registers. Note that updates using the VAP_PVS_VECTOR_DATA_REG will not update the GA registers.	4 IEEEfp

VECTOR MEMORY DESCRIPTIONS

There are two vector memories.

The vertex shader instruction store increased from 256 to 1024 for R5xx VS3.0.

The PVS_CODE memory which will be 1024 entries deep and can operate as a ring (similar to R200), is linearly addressed using offsets 0-1023. Auto-incrementing writes to this memory segment will auto-wrap back to 0 from 1023.

The PVS_CONST memory will be 256+8 entries deep. The first 256 entries of this memory will operate as a ring (similar to R200/R300), and are linearly addressed using offsets 1024-1535. Auto-incrementing writes to this memory segment will auto-wrap back to 1024 from 1535.

The last 8 entries of this memory are used for Clipping data which currently includes the User-Clip Planes , Point Sprite Viewport Scale vector, and Point Sprite Gen Tex Corner values. These entries will be updated starting at address 1536 through 1543. Since the PVS_CONST will auto-wrap at 1535 for constant updates, the UCP writes must start with an index update to 1536 or above. Auto-incrementing writes will auto-wrap back to 1536 from 1542 (NOT 1543). This wrap-around probably will never be used, but, note that the wrap-around intentionally excludes the Point Gen Tex vector since it is considered raster state.

These memories are not double-buffered in the code and constant range of addresses. For the code and const memories, it is expected that the driver will insert a flush if the currently being-loaded shader code or const overlaps the immediately preceding shader code or const. Updates to the UCP / PS_VPORT_SCALE / Point Gen Tex values are double-buffered and therefore no flush is required.

6.4.12 Scalar Indx / Data Registers

These memories and registers no longer exist for R300. The only data in them that is still relevant is the guard band data which now resides in dedicated registers as described below.

6.4.13 VAP_GB_VERT_CLIP_ADJ

The VAP_GB_* registers will only be single-buffered which means that a VAP_PVS_STATE_FLUSH_REG write must precede updates to these registers.

6.4.14 Programmable Vertex Shader Control Registers

The VAP_PVS_CNTL register allows control over which instructions in the PVS code store are executed with respect to the current shader.

The VAP_PVS_CONST_CNTL register allows control over which address ranges in the PVS const store (STVE) are used with respect to the current shader.

6.4.15 Vertex Blending Control Register

The COLOR2_IS_TEXTURE and COLOR3_IS_TEXTURE bits enable the R5xx VAP VS3.0 to support 10 general output vectors. For pre-R5xx, VAP supported 4 color vectors and 8 texture vectors to output to the pixel shader. During new clip vertex generation, the color interpolation supported color clamping and flat shading and the texture interpolation supported point texture coordinate generation and cylindrical wrap. In order to create general output vectors, color vectors required point texture coordinate generation and cylindrical wrap processing while texture vectors required color clamping and flat shading.

6.4.16 Texture to Color Control Registers

The TEX_RGB_SHADE_FUNC_(0-7), TEX_ALPHA_SHADE_FUNC_(0-7), and TEX_RGBA_CLAMP_(0-7) bits enable the R5xx VAP VS3.0 to support 10 general output vectors. For pre-R5xx, VAP supported 4 colors and 8 textures to output to the pixel shader. During new clip vertex generation, the color interpolation supported color clamping and flat shading and the texture interpolation supported point texture coordinate generation and cylindrical wrap. In order to create general output vectors, color vectors required point texture coordinate generation and cylindrical wrap processing while texture vectors required color clamping and flat shading.

The TEX_RGB_SHADE_FUNC_(0-7), TEX_ALPHA_SHADE_FUNC_(0-7), and TEX_RGBA_CLAMP_(0-7) bits enable the R5xx VAP VS3.0 to support color type interpolation during clipping on texture vectors. The bits enable flat shading or color clamping selectively on all 8 texture vectors. These bits only support clipper functionality of flat shading. The rasterizer has separate register bits to enable flat shading at pixel interpolation.

6.4.17 VAP_VTE_CNTL

This register is used to control the functionality of the VAP Viewport Transform Engine.

6.4.18 GA_COLOR_CONTROL

This register is used by the clipper to control flat shading of all 4 colors and alphas based off of the provoking vertex.

6.4.19 GA_ROUND_MODE

This register specifies the rounding mode for geometry & color SPFP to FP conversions. Only the RGB and ALPHA_CLAMP fields are used by VAP.

6.4.20 GA_POINT_S0/T0/S1/T1

These registers are used to control the texture coordinates for texture coordinate generation. These are only used by VAP for point clipping.

6.4.21 GB_ENABLE

This register is used by VAP to control when and how point textures are generated for clipping.

6.4.22 SU_TEX_WRAP

This register is used by VAP when clipping in order to perform cylindrical wrap clipping calculations.

6.5 R3xx-R5xx Programmable Vertex Shader Description

6.5.1 OVERVIEW

The R300 PVS model is a superset of the R200 PVS model. Differences are noted below.

R200->R300 Notable Shader Model Differences at Shader Definition Level

1. Constant Store Size Increase from 192 to 256
2. Code Store Size Increase from 128 to 256
3. Ability to increase Input Size from 16 to 32 vectors-per-vertex
4. Ability to increase Temp Register Size from 12 to 32 vectors-per-vertex
5. Increase support from 6 Output Textures to 8
6. Increase support from 2 Output Colors to 4 (4th color only used for 2-sided lighting)
7. Ability to perform flow control instructions of jump, loop and subroutine

R200->R300 Notable Shader Model Differences at Driver Compilation Level

1. Requirement to Manage NUM_SLOTS & NUM_CONTROLLERS based on Input, Output and Temp Register sizes relative to the respective vectors-per-vertex.
2. Requirement to “pack” output vectors based on OVFR.
3. Discrete Fog resides in one of Color 0-3 alpha.
4. Addition of Alternate Temp Memory. Can be used as additional standard Temp Memory.
5. Addition of Dual-Op Vector/Math Capability along with Alternate Temp Reg Memory
6. Ability to write back into Input Memory from Shader (For HOS Evaluation Shader)
7. Ability to use address register with Input, Output, and Temp registers as src and dest operands. There is not a current known use for this, but it was simple to add.

The R5xx VS3.0 PVS model is a superset of the R300 PVS VS2.0 model. Differences are noted below:

1. Ability to support dynamic flow control through the use of predication opcodes, predication bit, predicated writes, and a nested false count maintained in a temporary memory location.
2. Ability to support predication register through predication opcodes, predication bit, and predicated writes or use CONDITIONAL vector opcodes where sources are conditionally written or conditionally selected.
3. Code store size increase from 256 to 1024.
4. Temporary memory size increase from 72 to 128 (supports 4 threads and 32 vectors per thread).
5. Input memory size increase from 72 to 128 (supports 4 threads and 32 vectors per thread).
6. Output memory size increase from 72 to 128.
7. Static control flow nested loops and subroutines (4 deep loops and 4 deep subroutines)
8. Ability to access input, temporary, and output memories with inner most loop index.
9. Added new loop repeat type where the fixed-point loop index is not loaded at loop initialization. FLI is inherited from parent loop.
10. Added new source input modifier (absolute value).
11. Added new instruction modifier saturate to clamp outputs between 0 and 1.

The programmable vertex shader (PVS) is a model which replaces the standard DirectX / OGL vertex processing pipeline. It replaces only the per-vertex operations (i.e. transformation, lighting, texture coordinate generation, texture transform, fog), but does not replace any of the primitive operations (i.e. primitive assembly, clipping, backface culling, 2-sided lighting). The functional model for the PVS HW is as shown in the following diagram. For R300, 2-sided lighting is achieved by writing up to 4 output colors (both front and back color results) and allowing the setup engine to select the appropriate color(s) based on the facedness of the triangle.

The general model of the PVS is that all operands are of a vector type (4 floating point values). When there are scalar operations, generally they emit the scalar result on all 4 channels of the output vector.

The input vertex memory (IVM) represents the data which is provided on a per-vertex basis (i.e. position, normal, color, etc). This vertex data does not have any semantic attachment from the perspective of the shader HW. All

vertex attributes are generic. **There is a total of 128 vectors of IVM memory where up to 32 vectors (16 is typical) may be used per vertex. (See description of slot/controller dependencies below).**

The constant state memory (CSM) represents the constant values which are used in the shader process (i.e rotation matrices, light positions, etc). This data also has no semantic attachment from the perspective of the shader HW. **There are 256 vectors of constant memory available.**

The temporary register memory (TRM) represents the intermediate storage of temporary values computed during the shader process. **There are a total of 128 vectors of TRM memory where up to 32 vectors (12 is typical) may be used per vertex. (See description of slot/controller dependencies below).**

The alternate temporary register memory (ATRM) was added to R300 to allow both a vector engine operation and a math engine operation to output unique results simultaneously. The ATRM can be used in the same manner as the TRM for regular vector operations except there is only a single read port on the ATRM memory, thus only 1 unique source operand of an instruction may come from ATRM memory. The ATRM memory is the only memory that the math portion of a dual-math operation can write. **There are a total of 20 vectors of ATRM memory where up to 20 vectors (4 is typical) may be used per vertex. (See description of slot/controller dependencies below). (See description of dual math op for ATRM limitations).**

There are 4 address registers arranged as a vector (A0.x,y,z,w) which are signed integer fixed point values. The address registers can only be used as an offset to the address into the constant memory. The address registers are loaded using a MOV instruction from any of the IVM, CSM, TRM or ATRM. This special MOV instruction will perform a floating point to fixed point conversion of the selected source vector. There are two separate MOV instructions for unique float to fix conversion. One is a truncate to minus infinity (the floor() C function), the other is a round and truncate to minus infinity (val + 0.5f, followed by floor() C function. The value is clamped between the range of -256 and 255. When this value is added to the constant address of the current operation, the result is tested for in the range of 0 to MAX_SHADER_CONST where MAX_SHADER_CONST is determined by the driver as the maximum constant address provided by the shader declaration. If the resultant address is out of the range 0 to MAX_SHADER_CONST, (0,0,0,0) is returned on the data path. There is a 2-bit address register select for each source operand which is used to select between the x,y,z,w components of the address register vector. Only a single address register (component) may be used for CSM offsets across all of the source operands of a given instruction. If the address registers are used for offsets to IVM, TRM, ATRM, or OVM, there is no limitation on the number of address registers which can be used.

The output vertex memory (OVM) represents the data that is computed or passed by the shader program. These locations have semantics attached since they are passed through the clipping, viewport transform, rasterization process. The locations in the OVM are as follows:

PVS_OUT_POS	The output x,y,z,w position. This output vector must be written to by all shaders.
PVS_OUT_PT_SIZE	The output scalar point sprite size modifier. X-comp only.
PVS_OUT_CLR(0-3)	The output r,g,b,a colors. Support for 4.
PVS_OUT_TEX(0-7)	The output s,t,r,q textures. Support for 8.
PVS_OUT_FOG	The output scalar discrete fog. X-component only.

There are a total of 128 vectors of OUT memory. These values are mapped based on the compression described below. (See description of slot/controller dependencies below).

For R300, the driver must remap the shader output memory attributes to be “packed” into the first sequential output vectors based on the OVFR register definition. For example, if the only attributes present in the OVFR are Pos, Pt_Size, Clr1 and Tex 2, then these values must be written to output vectors 0-3. The order of the vectors, when present, is as listed above. Note that Fog does not have an associated vector, it can be placed in any of color 0-3 alpha channel. There is a GB_SELECT.FOG_SELECT setting in the raster to control where fog comes from.

Operations are defined generally as

```
PVS_OP DST_OP.write_mask SRC_OP_A.modifier SRC_OP_B.modifier
SRC_OP_C.modifier
```

Different PVS ops have differing numbers of source operands. The number of source operands for each instruction is specified below with the function descriptions.

One strict limitation of the PVS model is that a single operation may only use one unique address from the IVM, CSM, or ATRM. One, Two, or Three addresses may be used from the TRM (although 3 unique addresses from the TRM on a single instruction will take 2 cycles in the HW). More than one source operand may utilize the IVM, CSM, or ATRM memory as long as they all access the same vector address.

Each source operand has a modifier which can be applied on a per-component basis. There are two basic types of source operand modification, Swizzle and negation. The swizzle operation is performed first. For each component x,y,z,w it is possible to define independently which component gets mapped to these components, including a 0.0 or 1.0 value. So for each component you can select from (X, Y, Z, W, 0.0, 1.0). Following the swizzle operation, it is possible to specify a negation of the value on a per-component basis.

The destination operand has a write mask which allows any or all of the vector components to be updated. This is particularly useful when performing scalar output operations to pack the result into a single component of a vector value (since the scalar results are generally emitted on all component channels).

6.5.2 SLOT AND CONTROLLER MANAGEMENT

For R5xx, the input memory size, the temporary memory size, and the output memory size have been increased from 72 to 128 vectors. As stated below, with larger memories, the PVS design can run more efficiently with more NUM_SLOTS and more NUM_CNTRS.

The R300 PVS design has a degree of flexibility which allows the driver to increase the effective per-vertex sizes of the IVM, TRM, ATRM, and OVM memories at the expense of reduced performance. There are two variables in this performance tradeoff for R300: (NOTE: a vertex group is 8 vertices per group for R5xx since 8 vector engines)

- a. the number of slots (NUM_SLOTS): the max number of vertex groups that can reside from the input of vertex data to the IVM to the output of vertex data from the OVM, and
- b. the number of controllers (NUM_CNTRLRS): the max number of vertex groups that are available for vector engine processing at any given time.

The IVM and OVM memory flexibility is affected by NUM_SLOTS, while the TRM and ATRM memory flexibility is affected by the NUM_CNTLRS. In general, the higher the values for NUM_SLOTS and NUM_CNTLRS, the more efficient (higher performance) the PVS engine will run. The values for NUM_SLOTS and NUM_CNTLRS are restricted by the vectors-per-vertex required for the active vertex shader program.

The equations for determining valid values for these terms are as follows:

$$\text{NUM_SLOTS} \leq \text{MIN}(10, \text{IVM_SIZE} / \text{IVM_VEC_PER_VTX}, \text{OVM_SIZE} / \text{OVM_VEC_PER_VTX})$$

Where IVM_SIZE = 128, OVM_SIZE = 128 and IVM_VEC_PER_VTX and OVM_VEC_PER_VTX are vertex shader dependent values.

$$\text{NUM_CNTLRS} \leq \text{MIN}(5, \text{TRM_SIZE} / \text{TRM_VEC_PER_VTX}, \text{ATRM_SIZE} / \text{ATRM_VEC_PER_VTX})$$

Where TRM_SIZE = 128, ATRM_SIZE = 20, and TRM_VEC_PER_VTX and ATRM_VEC_PER_VTX are vertex shader dependent values.

Note that NUM_SLOTS and NUM_CNTLRS are permitted to be set too low, but there is a performance penalty for setting them lower.

Note that when changing NUM_SLOTS or NUM_CNTLRS, a flush of the PVS engine is required by writing the VAP_PVS_STATE_FLUSH_REG.

6.5.3 VS3.0 DYNAMIC FLOW CONTROL USING R5xx PREDICATION LOGIC

VS3.0 dynamic flow control is implemented on R5xx in a manner similar to R400 where vector engine operations and math engine operations are used to manipulate a predication bit to mask writes to the temporary memory, the output memory, the input memory, the alternate temporary memory, and the address register. The operations are designed to use a temporary memory location as a stack counter to keep the count of false branches. For nested if/else/endif branches, the operations receive as input the stack counter as well as the boolean operation to determine whether the predication bit is set and whether the stack counter is incremented or decremented. Within the if/else/endif construct, the ALU operations are predicated which kills the writes if the predication bit is not set.

A possible implementation of nested if/else/endif constructs is as follows:

```

if ( A.x == 0 ) {
    if ( A.y > 0 ) {
        B = C;
    } else {
        B = D;
    }
} else {
    If ( A.z >= 0 ) {
        B = E;
    } else {
        B = F;
    }
}

```

	TEMP.w = ME_PRED_SET_EQ	A.xxxx
	TEMP.w = VE_PRED_SET_GT_PUSH	TEMP.000w, A.000y
	B = C	with pred_enable = 1 and pred_sense = 1
	TEMP.w = ME_PRED_SET_INV	TEMP.000w
	B = D	with pred_enable = 1 and pred_sense = 1
	TEMP.w = ME_PRED_SET_POP	TEMP.000w
	TEMP.w = ME_PRED_SET_INV	TEMP.000w
	TEMP.w = VE_PRED_SET_GTE_PUSH	TEMP.000w, A.000z
	B = E	with pred_enable = 1 and pred_sense = 1
	TEMP.w = ME_PRED_SET_INV	TEMP.000w
	B = F	with pred_enable = 1 and pred_sense = 1
	TEMP.w = ME_PRED_SET_POP	TEMP.000w
	TEMP.w = ME_PRED_SET_POP	TEMP.000w

First level “if” statements turn in to ME_PRED_SET_EQ, ME_PRED_SET_GT, ME_PRED_SET_GTE, or ME_PRED_SET_NEQ depending on the boolean expression. The first level “If” statements appropriately initialize

the predication bit and false branch counter to 0 or 1 depending on the result of the boolean expression. Second level or deeper “If” statements turn in to VE_PRED_SET_EQ_PUSH, VE_PRED_SET_GT_PUSH, VE_PRED_SET_GTE_PUSH, or VE_PRED_SET_NEQ_PUSH. These “If” statements require the false branch counter as an additional input to determine the final status of the predication bit and the output false branch counter. For these “If” statements, the predication bit will only be set if the input false branch counter is 0 and the boolean expression is true. “Else” statements turn into ME_PRED_SET_INV, which also require the false branch counter as an input and only set the predication bit if this counter is 1. If the input false branch counter is 0, the ME_PRED_SET_INV sets the output false branch counter to 1 for later nesting and resets the predication bit. “Endif” statements turn into ME_PRED_SET_POP, which decrement and clamp the false branch counter to 0 if negative.

The ME_PRED_SET_CLR and ME_PRED_SET_RESTORE operations can be used for loop break statements. The ME_PRED_SET_CLR resets the predication bit and outputs maximum float to set the false branch counter to an extremely high number to disable successive operations in a breaked loop. The ME_PRED_SET_RESTORE operation can be used to restore the predication bit and the false branch counter after exiting a breaked loop.

In the R300 architecture, the best performance is achieved by trying to interlace computations so that an operations source is not the destination of the preceding operation. In the above example, the false branch stack counter stored in TEMP.w is a very popular source and destination operand, and R5xx performance would be better optimized by finding other operations to interlace between them.

6.5.4 VS3.0 PREDICATION AND SIMPLE DYNAMIC FLOW CONTROL USING R5xx CONDITIONAL OPCODES

In a manner similar to R400, R5xx has conditional moves, writes, or muxes to support VS3.0 predication and simple dynamic flow control. For predication support in VS3.0, a temporary memory vector can be used in place of a predication bit. VE_COND_WRITE_EQ, VE_COND_WRITE_GT, VE_COND_WRITE_GTE, and VE_COND_WRITE_NEQ have two input vector source operands where the first source operand is a conditional component write mask for the writing of the second source vector into the destination vector. An example of VS3.0 predication being supported with a conditional move or write is as follows:

```
P = pred_set_gt(A.xyzw,Bxyzw);          TEMPxyzw = VE_SET_GREATER_THAN(A.xyzw,Bxyzw);
(P) Cxyzw = Dxyzw;                    Cxyzw = VE_COND_WRITE_NEQ(TEMPxyzw,Dxyzw);
(!P) Cxyzw = Exyzw;                  Cxyzw = VE_COND_WRITE_EQ(TEMPxyzw,Exyzw);
```

Conditional mux opcodes include VE_COND_MUX_EQ, VE_COND_MUX_GT, and VE_COND_MUX_GTE have three input vector source operands where the first source operand is a component mux select selecting between the second and third source vectors to write the destination vector. The above example can simplified to the following:

```
TEMPxyzw = VE_SET_GREATER_THAN(A.xyzw,Bxyzw);
Cxyzw = VE_COND_MUX_EQ(TEMPxyzw,Exyzw,Dxyzw);
```

The primary limitation of the conditional mux opcodes is that only two of the three source operands can come from temporary memory since the temporary memory has only two read ports. A possible solution is using the input memory as a temporary location for one of the three source operands (the input memory can be written by the vector and math engine). Also, VE_COND_MUX operations could be reverted into two VE_COND_WRITE opcoders as above.

6.5.5 PVS FLOW CONTROL CAPABILITY

R300 adds the DX9 support for Vertex Shader Flow control. There are 3 types of flow control instructions: JMP, LOOP and JSR. Up to 16 total JMP, LOOP, and JSR instructions are allowed for any one shader program.

A JMP is a simple conditional JMP from one instruction to another instruction. Only forward jumps are allowed by DX9. The hardware is capable of backward jumps, but they are not recommended. There is not actually a conditional jump in R300, if the Boolean jump bit is not set, the the driver should disable the JMP.

A JSR instruction is a conditional Jump to Subroutine. Similar to the JMP, if the JSR Boolean control is disabled, the driver should disable the JSR. Upon reaching the activation instruction, (the JSR), a jump is made to the subroutine label (the jump address). The RET instruction is temporarily “activated” in the HW such that when the RET instruction is reached, it jumps back to the location specified in the VAP_PVS_FLOW_CNTL_ADDRS# register.

A LOOP instruction allows a set of instructions to be executed multiple times. Upon reaching the loop start instruction, the loop count is initialized and the fixed-point loop index register is initialized. The Loop End instruction address is temporarily “activated” such that when that instruction is reached, the loop count is decremented, the fixed-point loop index register is incremented (by inc_value) and it jumps back to the location specified in the VAP_PVS_FLOW_CNTL_ADDRS# register. When loop count is decremented to 0, the LOOP_END instruction is taken out of the temporarily activated list.

R5xx VS3.0 required the following changes to the PVS flow control capability:

1. Loops and subroutines can be nested up to four levels deep. The official definition is 4 levels of loops and 4 levels of subroutines. The actual R5xx implementation supports 8 total between loops and subroutines (any combination not to exceed 8). Some special points with regard to loop and subroutine nesting:
 - o Only the inner-most fixed-point loop index register is accessible for memory addressing.
 - o The inner-most fixed-point loop index is visible within all nested subroutines.
 - o The fixed-point loop index is initialized for a loop on the activation address for the loop.
2. R5xx support VS3.0 capability for fixed-point loop index addressing for constant memory, input memory, output memory and temporary memory. VS3.0 requires support for constant memory, input memory, and output memory. Address clamping is only provided for constant memory, and therefore shader validation should verify all fixed-point loop index register addressing is within input, output, or temporary boundaries for that vertex and loop.
3. R5xx supports VS3.0 capability for the loop repeat construct. The loop repeat is similar to a general loop except the fixed-point loop index is not initialized at the activation of the loop. The loop repeat inherits the fixed-point loop index from the above nested loop. Though the init value is not used, the loop step value is still used for the loop repeat. This enables the possibility for creative dual loop indexing of memories, but the general VS3.0 functionality would set the step value to 0. Upon loop repeat completion, the original fixed-point loop index is popped back to its pre-loop repeat value. Loop repeats can be nested and use the fixed-point loop index under a general loop.
4. R5xx VS3.0 supports 16 flow control instructions. VS3.0 treats flow control instructions in the same manner as ALU instructions and therefore has a logical maximum of 512 flow control instructions if no ALU instructions were used. However, the 16 R5xx flow control registers can really equate to approximately 32 VS3.0 flow control instructions since an R5xx loop instruction includes the loop begin and the loop end and a R5xx subroutine call includes the call, the subroutine start, and the subroutine return.

*NOTE: When a loop count is set to 0, the driver must change the loop instruction to a jump instruction to jump over the loop, since the control flow in the HW is done at the end of the loop.

Details on the language syntax are described below.

Caveats:

When a loop count is changed to 0, the driver must change this loop to be a jump to the end-of-loop label.

Jump Instruction

`jump b#, labelname;`

1. *b#* is a boolean flow control constant register signified by "b" and "#" can range from 0 to 15
2. *labelname* must be defined downstream and terminated with a ":"
3. There are 16 flow control constant registers of 1bit boolean type
4. Jumps are conditional (the jump will only occur if the value in the specified boolean flow control constant is '1')

Example

```
mul
mad
jump b2, end;
  mad
  rcp
end:
mul
out
```

Subroutine Call Instruction

`call b#, labelname;`

1. *b#* is a boolean flow control constant register signified by "b" and "#" can range from 0 to 15
2. *labelname* must be defined downstream and terminated with a ":"
3. There are 16 flow control constant registers of 1bit boolean type
4. Subroutine calls are conditional (the call will only occur if the value in the specified flow control constant is non-zero)
5. A subroutine block is defined as the code between the label referenced when called to the return from subroutine instruction
6. Loop instructions are allowed inside the subroutine block as long as the end of loop label is also within the same subroutine block
7. Nested subroutines and loops are allowed to a depth of 8 total.
8. A parent fixed-point index is visible through all subroutine nesting.

Example

```
call b5 normalize;
```

Return from Subroutine

```
ret;
```

1. The "ret" instruction is used to indicate the end of a subroutine

Example

```
normalize:
    dp3 r0.w, r0, r0;
    rsq r0.w r0.w;
    mul r0, r0, r0.w;
    ret;
```

Loop Instruction

```
loop i#, labelname;
```

1. *i#* is an integer flow control constant register signified by "i" and "#" can range from 0 to 15
2. The 'i' register is comprised of three components *i#.c* loop count (range 0 to 255), *i#.i* initial value (range from 0 to 255), and *i#.s* step value (range from -128 to 127) which when referenced as *i#* is an integer scalar defined by $i# = i#.i + n * i#.s$ where *n* is the number of times the loop has been traversed. The loop value is clamped to be in the range (-256 – 255) if it over/underflows.
3. For the "loop" instruction, only the first component (initial value) of the "i" register is used and the *i#.s* step value is ignored and treated as '1'
4. *labelname* must be defined downstream and terminated with a ":"
5. The loop will be traversed *i#.c* times regardless of the *i#.i* and *i#.s* values
6. A zero value *i#.c* loop count is treated as??? so may not be supported (the driver may be required to preprocess this case to be a jump to the end-of-loop label)
7. Jump instructions are allowed within a loop block as long as the jump target label is also within the same loop block
8. Jump Subroutine instructions are allowed within a loop block
9. Nested subroutines and loops are allowed to a depth of 8 total.

Example

```
mul
mad
loop i13, endloop;
    mad
    mul
endloop:
mul
out
```

Loop Instruction With Auto-Increment

```
iloop i#, labelname;
```

1. *i#* is an integer flow control constant register signified by "i" and "#" can range from

0 to 15

2. The 'i' register is comprised of three components *i#.c* loop count (range 0 to 255), *i#.i* initial value (range from 0 to 255), and *i#.s* step value (range from -128 to 127) which when referenced as *i#* is an integer scalar defined by $i\# = i\#.i + n * i\#.s$ where *n* is the number of times the loop has been traversed. The loop value is clamped to be in the range (-256 – 255) if it over/underflows.
3. *labelname* must be defined downstream and terminated with a ":"
4. The loop will be traversed *i#.c* times regardless of the *i#.i* and *i#.s* values
5. A zero value *i#.c* loop count is treated as??? so may not be supported (the driver may be required to preprocess this case to be a jump to the end-of-loop label)
6. Jump instructions are allowed within an *iloop* block as long as the jump target label is also within the same *iloop* block
7. Jump Subroutine instructions are allowed within an *iloop* block
8. Nested subroutines and loops are allowed to a depth of 8 total.
9. With nested loops, only the inner-most fixed-point loop index is accessible for ALU source operand addressing. The resulting address is not clamped for the input, output, and temporary memories so shader validation is required to ensure all addressing using the fixed-point loop index is within the boundaries for that vertex and loop.
10. A loop repeat construct does not initialize the fixed-point loop index. The loop repeat inherits the fixed-point loop index from the above nested loop. Though the init value is not used, the loop step value is still used for the loop repeat. This enables the possibility for creative dual loop indexing of memories, but the general VS3.0 functionality would set the step value to 0. Upon loop repeat completion, the original fixed-point loop index is popped to its pre-loop repeat value.

Example

```
mul
mad
iloop i5, endloop;
    mul
    mad r0, r0, c[i5]; // faster to use loop counter than a0
    add
endloop:
mul
out
```

6.5.6 DUAL MATH OP USAGE

The R300 PVS design enables the ability to use both the Vector Engine and the Math Engine on the same clock. An instruction which combines a Vector Engine and a Math Engine instruction will be termed a Dual-Math Instruction. A Dual-Math Instruction has the following restrictions:

The Vector Instruction of a Dual-Math Inst must not use more than 2 source operands because the Math Instruction definition is stored in the 3rd source operand bits of the instruction field.

The Math Instruction of a Dual-Math Inst must have 2 or less source scalar operands which must both come from a single source vector. Swizzles enable the two scalar operands to come from any components of the single source vector.

The Vector Instruction of a Dual-Math Inst cannot have the destination operand use the ATRM memory.

The Math Instruction of a Dual-Math Inst can only use the ATRM memory as the destination operand and can only write to locations 0-3 and cannot use relative addressing (address register).

The combined instructions source operands must conform to the same memory restrictions as a single op (1 unique src from CSM, IVM, ATRM, 2 unique src from TRM (3 unique src from TRM only allowed for single op Vector Macro inst)).

6.5.7 **VECTOR INSTRUCTIONS**

VE_DOT_PRODUCT: 2 VECTOR SOURCE OPERANDS

$$\text{OUT.X} = ((\text{IN_A.X} * \text{IN_B.X}) + (\text{IN_A.Y} * \text{IN_B.Y}) \\ + (\text{IN_A.Z} * \text{IN_B.Z}) + (\text{IN_A.W} * \text{IN_B.W}));$$

$$\text{OUT.Y} = \text{OUT.Z} = \text{OUT.W} = \text{OUT.X}$$

VE_MULTIPLY: 2 VECTOR SOURCE OPERANDS

$$\text{OUT.X} = \text{IN_A.X} * \text{IN_B.X};$$

$$\text{OUT.Y} = \text{IN_A.Y} * \text{IN_B.Y};$$

$$\text{OUT.Z} = \text{IN_A.Z} * \text{IN_B.Z};$$

$$\text{OUT.W} = \text{IN_A.W} * \text{IN_B.W};$$

VE_ADD: 2 VECTOR SOURCE OPERANDS

$$\text{OUT.X} = \text{IN_A.X} + \text{IN_B.X};$$

$$\text{OUT.Y} = \text{IN_A.Y} + \text{IN_B.Y};$$

$$\text{OUT.Z} = \text{IN_A.Z} + \text{IN_B.Z};$$

$$\text{OUT.W} = \text{IN_A.W} + \text{IN_B.W};$$

VE_MULTIPLY_ADD: 3 VECTOR SOURCE OPERANDS (MACRO IF 3 UNIQUE TEMPS)

$$\text{OUT.X} = (\text{IN_A.X} * \text{IN_B.X}) + \text{IN_C.X};$$

$$\text{OUT.Y} = (\text{IN_A.Y} * \text{IN_B.Y}) + \text{IN_C.Y};$$

$$\text{OUT.Z} = (\text{IN_A.Z} * \text{IN_B.Z}) + \text{IN_C.Z};$$

$$\text{OUT.W} = (\text{IN_A.W} * \text{IN_B.W}) + \text{IN_C.W};$$

VE_DISTANCE_VECTOR: 2 VECTOR SOURCE OPERANDS
$$\text{OUT.X} = 1.0;$$
$$\text{OUT.Y} = \text{IN_A.Y} * \text{IN_B.Y};$$
$$\text{OUT.Z} = \text{IN_A.Z};$$
$$\text{OUT.W} = \text{IN_B.W};$$

Potentially useful as follows (XX = Don't Care, D = Depth)

$$\text{IN_A} = (\text{XX}, D * D, D * D, \text{XX})$$
$$\text{IN_B} = (\text{XX}, 1 / D, \text{XX}, 1 / D)$$
$$\text{OUT} = (1.0, D, D * D, 1 / D) \text{ for light attenuation multiply.}$$
VE_FRACTION: 1 VECTOR SOURCE OPERAND
$$\text{OUT.X} = \text{IN_A.X} - \text{FLOOR}(\text{IN_A.X});$$
$$\text{OUT.Y} = \text{IN_A.Y} - \text{FLOOR}(\text{IN_A.Y});$$
$$\text{OUT.Z} = \text{IN_A.Z} - \text{FLOOR}(\text{IN_A.Z});$$
$$\text{OUT.W} = \text{IN_A.W} - \text{FLOOR}(\text{IN_A.W});$$

This function returns the positive difference between a floating point number and the largest integer number less than the floating point number.

VE_MAXIMUM: 2 VECTOR SOURCE OPERANDS
$$\text{OUT.X} = \text{MAX}(\text{IN_A.X}, \text{IN_B.X});$$
$$\text{OUT.Y} = \text{MAX}(\text{IN_A.Y}, \text{IN_B.Y});$$
$$\text{OUT.Z} = \text{MAX}(\text{IN_A.Z}, \text{IN_B.Z});$$
$$\text{OUT.W} = \text{MAX}(\text{IN_A.W}, \text{IN_B.W});$$
VE_MINIMUM: 2 VECTOR SOURCE OPERANDS
$$\text{OUT.X} = \text{MIN}(\text{IN_A.X}, \text{IN_B.X});$$
$$\text{OUT.Y} = \text{MIN}(\text{IN_A.Y}, \text{IN_B.Y});$$
$$\text{OUT.Z} = \text{MIN}(\text{IN_A.Z}, \text{IN_B.Z});$$

OUT.W = MIN(IN_A.W, IN_B.W);

VE_SET_GREATER_THAN_EQUAL: 2 VECTOR SOURCE OPERANDS

OUT.X = (IN_A.X >= IN_B.X) ? 1.0 : 0.0;

OUT.Y = (IN_A.Y >= IN_B.Y) ? 1.0 : 0.0;

OUT.Z = (IN_A.Z >= IN_B.Z) ? 1.0, 0.0;

OUT.W = (IN_A.W >= IN_B.W) ? 1.0, 0.0;

VE_SET_LESS_THAN: 2 VECTOR SOURCE OPERANDS

OUT.X = (IN_A.X < IN_B.X) ? 1.0, 0.0;

OUT.Y = (IN_A.Y < IN_B.Y) ? 1.0, 0.0;

OUT.Z = (IN_A.Z < IN_B.Z) ? 1.0, 0.0;

OUT.W = (IN_A.W < IN_B.W) ? 1.0, 0.0;

VE_MULTIPLYX2_ADD: 3 VECTOR SOURCE OPERANDS (MACRO IF 3 UNIQUE TEMPS)

OUT.X = (2.0 * (IN_A.X * IN_B.X)) + IN_C.X;

OUT.Y = (2.0 * (IN_A.Y * IN_B.Y)) + IN_C.Y;

OUT.Z = (2.0 * (IN_A.Z * IN_B.Z)) + IN_C.Z;

OUT.W = (2.0 * (IN_A.W * IN_B.W)) + IN_C.W;

VE_MULTIPLY_CLAMP: 3 VECTOR SOURCE OPERANDS (NO MACRO -> NO 3 UNIQUE TEMPS)

```
IF(C.W < (A.W * B.W)) {
    OUT.X = C.W;
} ELSE IF(C.X >= (A.X * B.X)) {
    OUT.X = C.X;
} ELSE {
    OUT.X = A.X * B.X;
}
```

OUT.Y = OUT.Z = OUT.W = OUT.X;

This function is used for point sprite clamping. May or may not be useful for other functions.

VE_FLT2FIX_DX: 1 VECTOR SOURCE OPERAND

OUT.X = FLOOR(IN_A.X);

OUT.Y = FLOOR(IN_A.Y);

OUT.Z = FLOOR(IN_A.Z);

OUT.W = FLOOR(IN_A.W);

This function is a component-wise float to fixed conversion which returns the largest integer less than the input value. This function is used to load the address register.

VE_FLT2FIX_DX_RND: 1 VECTOR SOURCE OPERAND

OUT.X = FLOOR(IN_A.X + 0.5);

OUT.Y = FLOOR(IN_A.Y + 0.5);

OUT.Z = FLOOR(IN_A.Z + 0.5);

OUT.W = FLOOR(IN_A.W + 0.5);

This function is a component-wise float to fixed conversion which returns the nearest integer to the input value. This function is used to load the address register.

VE_PRED_SET_EQ_PUSH: 2 VECTOR SOURCE OPERANDS

IF((IN_B.W==0) && (IN_A.W==0)) {

 PREDICATE_BIT = 1;

 OUT.W = 0;

} ELSE {

 PREDICATE_BIT = 0;

 OUT.W = IN_A.W + 1.0;

}

OUT.X = OUT.Y = OUT.Z = OUT.W;

VE_PRED_SET_GT_PUSH: 2 VECTOR SOURCE OPERANDS

IF((IN_B.W>0) && (IN_A.W==0)) {

```
PREDICATE_BIT = 1;

OUT.W = 0;

} ELSE {

    PREDICATE_BIT = 0;

    OUT.W = IN_A.W + 1.0;

}

OUT.X = OUT.Y = OUT.Z = OUT.W;
```

VE_PRED_SET_GTE_PUSH: 2 VECTOR SOURCE OPERANDS

```
IF( (IN_B.W>=0) && (IN_A.W==0) ) {

    PREDICATE_BIT = 1;

    OUT.W = 0;

} ELSE {

    PREDICATE_BIT = 0;

    OUT.W = IN_A.W + 1.0;

}

OUT.X = OUT.Y = OUT.Z = OUT.W;
```

VE_PRED_SET_NEQ_PUSH: 2 VECTOR SOURCE OPERANDS

```
IF( (IN_B.W!=0) && (IN_A.W==0) ) {

    PREDICATE_BIT = 1;

    OUT.W = 0;

} ELSE {

    PREDICATE_BIT = 0;

    OUT.W = IN_A.W + 1.0;

}

OUT.X = OUT.Y = OUT.Z = OUT.W;
```

VE_COND_WRITE_EQ4 : 2 VECTOR SOURCE OPERANDS

```
WRITE_ENABLE[0] = ( IN_A.X==0 ) ? 1 : 0;
```



```
WRITE_ENABLE[1] = ( IN_A.Y==0 ) ? 1 : 0;
WRITE_ENABLE[2] = ( IN_A.Z==0 ) ? 1 : 0;
WRITE_ENABLE[3] = ( IN_A.W==0 ) ? 1 : 0;
OUT = IN_B;
```

VE_COND_WRITE_GT4 : 2 VECTOR SOURCE OPERANDS

```
WRITE_ENABLE[0] = ( IN_A.X>0 ) ? 1 : 0;
WRITE_ENABLE[1] = ( IN_A.Y>0 ) ? 1 : 0;
WRITE_ENABLE[2] = ( IN_A.Z>0 ) ? 1 : 0;
WRITE_ENABLE[3] = ( IN_A.W>0 ) ? 1 : 0;
OUT = IN_B;
```

VE_COND_WRITE_GTE4 : 2 VECTOR SOURCE OPERANDS

```
WRITE_ENABLE[0] = ( IN_A.X>=0 ) ? 1 : 0;
WRITE_ENABLE[1] = ( IN_A.Y>=0 ) ? 1 : 0;
WRITE_ENABLE[2] = ( IN_A.Z>=0 ) ? 1 : 0;
WRITE_ENABLE[3] = ( IN_A.W>=0 ) ? 1 : 0;
OUT = IN_B;
```

VE_COND_WRITE_NEQ4 : 2 VECTOR SOURCE OPERANDS

```
WRITE_ENABLE[0] = ( IN_A.X!=0 ) ? 1 : 0;
WRITE_ENABLE[1] = ( IN_A.Y!=0 ) ? 1 : 0;
WRITE_ENABLE[2] = ( IN_A.Z!=0 ) ? 1 : 0;
WRITE_ENABLE[3] = ( IN_A.W!=0 ) ? 1 : 0;
OUT = IN_B;
```

VE_COND_MUX_EQ4 : 3 VECTOR SOURCE OPERANDS

// only 2 unique input vectors can be from temporary storage

```
OUT.X = ( IN_A.X==0 ) ? IN_B.X : IN_C.X;
OUT.Y = ( IN_A.Y==0 ) ? IN_B.Y : IN_C.Y;
OUT.Z = ( IN_A.Z ==0 ) ? IN_B.Z : IN_C.Z;
```

OUT.W = (IN_A.W==0) ? IN_B.W : IN_C.W;

VE_COND_MUX_GT4 : 3 VECTOR SOURCE OPERANDS

// only 2 unique input vectors can be from temporary storage

OUT.X = (IN_A.X>0) ? IN_B.X : IN_C.X;

OUT.Y = (IN_A.Y>0) ? IN_B.Y : IN_C.Y;

OUT.Z = (IN_A.Z >0) ? IN_B.Z : IN_C.Z;

OUT.W = (IN_A.W>0) ? IN_B.W : IN_C.W;

VE_COND_MUX_GTE4 : 3 VECTOR SOURCE OPERANDS

// only 2 unique input vectors can be from temporary storage

OUT.X = (IN_A.X>=0) ? IN_B.X : IN_C.X;

OUT.Y = (IN_A.Y>=0) ? IN_B.Y : IN_C.Y;

OUT.Z = (IN_A.Z >=0) ? IN_B.Z : IN_C.Z;

OUT.W = (IN_A.W>=0) ? IN_B.W : IN_C.W;

VE_SET_GREATER_THAN: 2 VECTOR SOURCE OPERANDS

OUT.X = (IN_A.X > IN_B.X) ? 1.0 : 0.0;

OUT.Y = (IN_A.Y > IN_B.Y) ? 1.0 : 0.0;

OUT.Z = (IN_A.Z > IN_B.Z) ? 1.0, 0.0;

OUT.W = (IN_A.W > IN_B.W) ? 1.0, 0.0;

VE_SET_EQUAL: 2 VECTOR SOURCE OPERANDS

OUT.X = (IN_A.X == IN_B.X) ? 1.0 : 0.0;

OUT.Y = (IN_A.Y == IN_B.Y) ? 1.0 : 0.0;

OUT.Z = (IN_A.Z == IN_B.Z) ? 1.0, 0.0;

OUT.W = (IN_A.W == IN_B.W) ? 1.0, 0.0;

VE_SET_NOT_EQUAL: 2 VECTOR SOURCE OPERANDS

OUT.X = (IN_A.X != IN_B.X) ? 1.0 : 0.0;

OUT.Y = (IN_A.Y != IN_B.Y) ? 1.0 : 0.0;

OUT.Z = (IN_A.Z != IN_B.Z) ? 1.0, 0.0;

OUT.W = (IN_A.W != IN_B.W) ? 1.0, 0.0;

NOTES

- * A Vector Move Instruction can be accomplished via a VE_ADD with other source operand set to (0,0,0,0).
- * A 3-Component Dot Product can be accomplished via a VE_DOT_PRODUCT with 4th components forced to 0.0.

6.5.8 SCALAR INSTRUCTIONS

The scalar (math) instructions have changed their src operands somewhat for R300. The general rules are as follows:

1. Only w channels of src operands are available for math ops
2. For all 1 source operand instructions, the input is IN_A.W (except for ME_EXP_BASEE_FF because of rule 3 below)
3. All source operands which are powers (e^x , 2^x , x^y , etc) will be on IN_C.W, all source operands which are bases will be on IN_A.W and all sources which are clamps will be on IN_B.W. As long as the compiler (driver) replicates the last valid src operand to all unused src operands, the behavior looks clean as follows:
 - i. 1 source operand instructions (like e^x), the x would be in IN_C.W, but it can appear as if in IN_A.W as long as this value is replicated
 - ii. 2 source operand instructions (like x^y), the base is in the IN_A.W, and the pow is in IN_C.W, but it can appear as if in IN_B.W as long as this value is replicated.

All of the function definitions below are written with the assumption that the last valid source operand is replicated to the “unused” source operands. The HW does not always use the source operands specified, sometimes it relies on the replication. These will be noted in comments below.

ME_EXP_BASE2_DX: 1 SCALAR SOURCE OPERAND

```

OUT.X = 2 ^ FLOOR(IN_A.W);

IF (IN_A.W > 128.0) {

    OUT.Y = 0.0; //NOTE: THIS IS NOT EQUIV TO DX BEHAVIOR

} ELSE {

    OUT.Y = FRAC(IN_A.W);

}

OUT.Z = 2 ^ (IN_A.W);

OUT.W = 1.0;
```

ME_LOG_BASE2_DX: 1 SCALAR SOURCE OPERAND

```

IF(IN_A.W == 0.0) {
    OUT.X = MINUS_MAX_FLOAT;
```

```

        OUT.Y = 1.0;

        OUT.Z = MINUS_MAX_FLOAT;

        OUT.W = 1.0;

    } ELSE {

        OUT.X = Unbiased exponent of ABS(IN_A.W) as float(i.e. 4.0 -> 2.0);

        OUT.Y = mantissa of IN_A.W as float (1.0 <= OUT.Y < 2.0);

        OUT.Z = LOG2(ABS(IN_A.W));

        OUT.W = 1.0;

    }

```

ME_EXP_BASEE_FF: 1 SCALAR SOURCE OPERAND

OUT.X = $e^{(IN_A.W)}$; //NOTE WAS IN_A.X FOR R200 *FROM C.W, IN_A.W if operand replicate

```
OUT.Y = OUT.Z = OUT.W = OUT.X;
```

ME_LIGHT_COEFF_DX: 3 SCALAR SOURCE OPERANDS (NO MACRO -> NO 3 UNIQUE TEMPS)

This function was a single vector source operand for R200. Now it uses 3 vector source operands (w components only).

The 3 operands may be the same vector using different swizzles to emulate R200 behavior.

```

        OUT.X = 1.0;

        OUT.Y = MAX(IN_B.W, 0.0);

        IF(IN_B.W > 0) {

            IN_C.W = CLAMP(IN_C.W, -128.0, 128.0);

            OUT.Z = (MAX(IN_A.W, 0.0)) ^ IN_C.W;

        } ELSE {

            OUT.Z = 0.0;

        }

        OUT.W = 1.0;

```

ME_POWER_FUNC_FF: 2 SCALAR SOURCE OPERANDS (IN ONE VECTOR)

```

IF(IN_A.W < 0.0) {
    OUT.X = - (ABS(IN_A.W) ^ IN_B.W); //IN_B.W is from IN_C.W, but same if operand
replicate
} ELSE {
    OUT.X = IN_A.W ^ IN_B.W;
}

```

OUT.Y = OUT.Z = OUT.W = OUT.X;

Special cases (in order of detection) are (using x^n notation):

$0.0^{-n} \rightarrow$ Plus Infinity

$0.0^n \rightarrow 0.0$

$x^{0.0} \rightarrow 1.0$

$\text{Inf}^{-n} \rightarrow 0.0$

$\text{Inf}^n \rightarrow \text{Inf}$

IF ($x > 1.0$ and $n == -\text{Inf}$) $\rightarrow 0.0$

IF ($x < 1.0$ and $n == -\text{Inf}$) $\rightarrow \text{Inf}$

IF ($x > 1.0$ and $n == \text{Inf}$) $\rightarrow \text{Inf}$

IF ($x < 1.0$ and $n == \text{Inf}$) $\rightarrow 0.0$

ME_RECIP_DX: 1 SCALAR SOURCE OPERAND

OUT.X = $1.0 / \text{IN_A.W}$

OUT.Y = OUT.Z = OUT.W = OUT.X;

An input of 0.0 yields a result of MAX_FLOAT.

ME_RECIP_FF: 1 SCALAR SOURCE OPERAND

OUT.X = $1.0 / \text{IN_A.W}$

OUT.Y = OUT.Z = OUT.W = OUT.X;

An input of 0.0 yields a result of zero.

ME_RECIP_SQRT_DX: 1 SCALAR SOURCE OPERAND

OUT.X = $1.0 / \text{SQRT}(\text{ABS}(\text{IN_A.W}))$

OUT.Y = OUT.Z = OUT.W = OUT.X;

An input of 0.0 yields a result of MAX_FLOAT.

ME_RECIP_SQRT_FF: 1 SCALAR SOURCE OPERAND

OUT.X = 1.0 / SQRT(ABS(IN_A.W))

OUT.Y = OUT.Z = OUT.W = OUT.X;

An input of 0.0 yields a result of zero.

ME_MULTIPLY: 2 SCALAR SOURCE OPERANDS (IN ONE VECTOR)

OUT.X = IN_A.W * IN_B.W;

OUT.Y = OUT.Z = OUT.W = OUT.X;

ME_EXP_BASE2: 1 SCALAR SOURCE OPERAND

OUT.X = 2.0 ^ (IN_A.W); */*FROM C.W, IN_A.W if operand replicate*

OUT.Y = OUT.Z = OUT.W = OUT.X;

ME_LOG_BASE2: 1 SCALAR SOURCE OPERAND

OUT.X = LOG2(ABS(IN_A.W));

OUT.Y = OUT.Z = OUT.W = OUT.X;

An input of 0.0 yields a result of MINUS_MAX_FLOAT.

ME_POWER_FUNC_FF_CLAMP_B: 3 SCALAR SOURCE OPERANDS (NO MACRO)

IF (IN_A.W < IN_B.W) { *//IN_B.W is the clamp value.*

OUT.X = 0.0;

} ELSE {

SAME BEHAVIOR AS ME_POWER_FUNC_FF WITH IN_A.W as base and IN_C.W as power (not IN_B.W).

}

OUT.Y = OUT.Z = OUT.W = OUT.X;

ME_POWER_FUNC_FF_CLAMP_B1: 3 SCALAR SOURCE OPERANDS (NO MACRO)

IF (IN_A.W < IN_B.W) { *//IN_B.W is the clamp value.*

OUT.X = 0.0;

} ELSE IF (IN_A.W > 1.0) {

```

    OUT.X = 1.0;
} ELSE {
    SAME BEHAVIOR AS ME_POWER_FUNC_FF WITH IN_A.W as base and IN_C.W as
power (not IN_B.W).
}
OUT.Y = OUT.Z = OUT.W = OUT.X;

```

ME_POWER_FUNC_FF_CLAMP_01: 2 SCALAR SOURCE OPERANDS

```

IF (IN_A.W <= 0.0) {
    OUT.X = 0.0;
} ELSE IF (IN_A.W > 1.0) {
    OUT.X = 1.0;
} ELSE {
    SAME BEHAVIOR AS ME_POWER_FUNC_FF
}
OUT.Y = OUT.Z = OUT.W = OUT.X;

```

ME_SIN: 1 SCALAR SOURCE OPERAND

```
OUT.X = SIN(IN_A.W);
```

```
OUT.Y = OUT.Z = OUT.W = OUT.X;
```

The hardware implementation of SIN/COS clamps the input, including nans and infs, to $-\pi$ to $+\pi$ before computing the output, so for any inputs outside that range, $\cos(x) = -1$ and $\sin(x) = 0$. Except for inputs of zero where $\sin(0) = 0$, the minimum value that this function will output is $\pm 0x33800000$. In other words, the absolute value of the output is clamped to $0x33800000$ minimum except for $\sin(0)$ and $\sin(\pm\pi)$.

ME_COS: 1 SCALAR SOURCE OPERAND

```
OUT.X = COS(IN_A.W);
```

```
OUT.Y = OUT.Z = OUT.W = OUT.X;
```

The hardware implementation of SIN/COS clamps the input, including nans and infs, to $-\pi$ to $+\pi$ before computing the output, so for any inputs outside that range, $\cos(x) = -1$ and $\sin(x) = 0$. Except for inputs of zero where $\sin(0) = 0$, the minimum value that this function will output is $\pm 0x33800000$. In other words, the absolute value of the output is clamped to $0x33800000$ minimum except for $\sin(0)$ and $\sin(\pm\pi)$.

ME_LOG_BASE2_IEEE: 1 SCALAR SOURCE OPERAND

OUT.X = LOG2(ABS(IN_A.W));

OUT.Y = OUT.Z = OUT.W = OUT.X;

An input of 0.0 yields a result of minus infinity.

ME_RECIP_IEEE: 1 SCALAR SOURCE OPERAND

OUT.X = 1.0 / IN_A.W

OUT.Y = OUT.Z = OUT.W = OUT.X;

An input of 0.0 yields a result of infinity.

ME_RECIP_SQRT_IEEE: 1 SCALAR SOURCE OPERAND

OUT.X = 1.0 / SQRT(ABS(IN_A.W))

OUT.Y = OUT.Z = OUT.W = OUT.X;

An input of 0.0 yields a result of infinity.

ME_PRED_SET_EQ: 1 SCALAR SOURCE OPERAND

```
IF(IN_A.W==0) {  
    PREDICATE_BIT = 1;  
    OUT.X = OUT.Y = OUT.Z = OUT.W = 0;  
} ELSE {  
    PREDICATE_BIT = 0;  
    OUT.X = OUT.Y = OUT.Z = OUT.W = 1;  
}
```

ME_PRED_SET_GT: 1 SCALAR SOURCE OPERAND

```
IF(IN_A.W > 0) {  
    PREDICATE_BIT = 1;  
    OUT.X = OUT.Y = OUT.Z = OUT.W = 0;  
} ELSE {  
    PREDICATE_BIT = 0;  
    OUT.X = OUT.Y = OUT.Z = OUT.W = 1;  
}
```

ME_PRED_SET_GTE: 1 SCALAR SOURCE OPERAND

```
IF(IN_A.W >= 0) {  
    PREDICATE_BIT = 1;  
    OUT.X = OUT.Y = OUT.Z = OUT.W = 0;  
} ELSE {  
    PREDICATE_BIT = 0;  
    OUT.X = OUT.Y = OUT.Z = OUT.W = 1;  
}
```

ME_PRED_SET_NEQ: 1 SCALAR SOURCE OPERAND

```
IF(IN_A.W != 0) {  
    PREDICATE_BIT = 1;  
    OUT.X = OUT.Y = OUT.Z = OUT.W = 0;  
} ELSE {  
    PREDICATE_BIT = 0;  
    OUT.X = OUT.Y = OUT.Z = OUT.W = 1;  
}
```

ME_PRED_SET_CLR: 0 SCALAR SOURCE OPERANDS

```
PREDICATE_BIT = 1;  
OUT.X = OUT.Y = OUT.Z = OUT.W = MAX_FLOAT;
```

ME_PRED_SET_INV: 1 SCALAR SOURCE OPERAND

```
IF(IN_A.W==1) {  
    PREDICATE_BIT = 1;  
    OUT.X = OUT.Y = OUT.Z = OUT.W = 0;  
} ELSE {  
    PREDICATE_BIT = 0;  
    IF(IN_A.W==0) {  
        OUT.X = OUT.Y = OUT.Z = OUT.W = 1;  
    }
```

```

    } ELSE {
        OUT.X = OUT.Y = OUT.Z = OUT.W = IN_A.W;
    }
}

```

ME_PRED_SET_POP: 1 SCALAR SOURCE OPERAND

```

OUT.W = IN_A.W - 1.0;
IF(OUT.W < 0) {
    PREDICATE_BIT = 1;
    OUT.W = 0;
} ELSE {
    PREDICATE_BIT = 0;
}
OUT.X = OUT.Y = OUT.Z = OUT.W;

```

ME_PRED_SET_RESTORE: 1 SCALAR SOURCE OPERAND

```

IF(IN_A.W==0) {
    PREDICATE_BIT = 1;
    OUT.X = OUT.Y = OUT.Z = OUT.W = 0;
} ELSE {
    PREDICATE_BIT = 0;
    OUT.X = OUT.Y = OUT.Z = OUT.W = IN_A.W;
}

```

6.5.9 PVS INSTRUCTION DEFINITION

The memory selects (or register type) valid selections are as follows:

SOURCE REG_TYPES:

```

PVS_SRC_REG_TEMPORARY      = 0; //Intermediate storage
PVS_SRC_REG_INPUT          = 1; //Input Vertex Storage

```

```

PVS_SRC_REG_CONSTANT    = 2; //Constant State Storage
PVS_SRC_REG_ALT_TEMPORARY = 3; //Alternate Intermediate Storage

```

The valid swizzle selects are as follows:

```

PVS_SRC_SELECT_X        = 0; //Select X Component
PVS_SRC_SELECT_Y        = 1; //Select Y Component
PVS_SRC_SELECT_Z        = 2; //Select Z Component
PVS_SRC_SELECT_W        = 3; //Select W Component
PVS_SRC_SELECT_FORCE_0  = 4; //Force Component to 0.0
PVS_SRC_SELECT_FORCE_1  = 5; //Force Component to 1.0

```

For R5xx VS3.0, the PVS_SRC_ABS_XYZW bits enables the absolute value for the four components of the source vector.

For R5xx VS3.0, the PVS_DST_VE_SAT and PVS_DST_ME_SAT bits enable a zero to one saturate clamp for all four component of the output.

For R5xx VS3.0, the PVS_DST_PRED_ENABLE and PVS_DST_PRED_SENSE bits enable predicated writes for the temporary memory, the output memory, the alternate temporary memory, the address register, and the input memory. The PVS_DST_PRED_ENABLE enables the feature while PVS_DST_PRED_SENSE determines the polarity of the predication bit for the write to be enabled. When the predication bit matches the predication sense, the predicated write is enabled. For dual vector/math engine operations, both operations are predicated.

The PVS_DST_MACRO_INST bit was meant to be used for MACROS such as a vector-matrix multiply, but currently is only set for the following cases:

- A VE_MULTIPLY_ADD or VE_MULTIPLYX2_ADD instruction with all 3 source operands using unique PVS_REG_TEMPORARY vector addresses. Since R300 only has two read ports on the temporary memory, this special case of these instructions is broken up (by the HW) into 2 operations.
- When the MACRO enable bit is set, the opcode (lower 6 bits is remapped as follows:

```

PVS_MACRO_OP_2CLK_MADD = 0
PVS_MACRO_OP_2CLK_M2X_ADD = 1

```

The PVS_DST_MATH_INST is used to identify whether the instruction is a Vector Engine instruction or a Math Engine instruction.

The PVS_DST_OPCODE values are listed below:

```

VECTOR_NO_OP           = 0
VE_DOT_PRODUCT         = 1

```

VE_MULTIPLY	= 2
VE_ADD	= 3
VE_MULTIPLY_ADD	= 4
VE_DISTANCE_VECTOR	= 5
VE_FRACTION	= 6
VE_MAXIMUM	= 7
VE_MINIMUM	= 8
VE_SET_GREATER_THAN_EQUAL	= 9
VE_SET_LESS_THAN	= 10
VE_MULTIPLYX2_ADD	= 11
VE_MULTIPLY_CLAMP	= 12
VE_FLT2FIX_DX	= 13
VE_FLT2FIX_DX_RND	= 14
// NEW R5xx OPCODES - below	
VE_PRED_SET_EQ_PUSH	= 15
VE_PRED_SET_GT_PUSH	= 16
VE_PRED_SET_GTE_PUSH	= 17
VE_PRED_SET_NEQ_PUSH	= 18
VE_COND_WRITE_EQ	= 19
VE_COND_WRITE_GT	= 20
VE_COND_WRITE_GTE	= 21
VE_COND_WRITE_NEQ	= 22
VE_COND_MUX_EQ	= 23
VE_COND_MUX_GT	= 24
VE_COND_MUX_GTE	= 25
VE_SET_GREATER_THAN	= 26
VE_SET_EQUAL	= 27
VE_SET_NOT_EQUAL	= 28
MATH_NO_OP	= 0
ME_EXP_BASE2_DX	= 1
ME_LOG_BASE2_DX	= 2
ME_EXP_BAS2_FF	= 3
ME_LIGHT_COEFF_DX	= 4
ME_POWER_FUNC_FF	= 5
ME_RECIP_DX	= 6
ME_RECIP_FF	= 7
ME_RECIP_SQRT_DX	= 8
ME_RECIP_SQRT_FF	= 9
ME_MULTIPLY	= 10
ME_EXP_BASE2_FULL_DX	= 11
ME_LOG_BASE2_FULL_DX	= 12
ME_POWER_FUNC_FF_CLAMP_B	= 13
ME_POWER_FUNC_FF_CLAMP_B1	= 14
ME_POWER_FUNC_FF_CLAMP_01	= 15
ME_SIN	= 16
ME_COS	= 17
// NEW R5xx OPCODES - below	
ME_LOG_BASE2_IEEE	= 18
ME_RECIP_IEEE	= 19
ME_RECIP_SQRT_IEEE	= 20
ME_PRED_SET_EQ	= 21
ME_PRED_SET_GT	= 22
ME_PRED_SET_GTE	= 23

ME_PRED_SET_NEQ	= 24
ME_PRED_SET_CLR	= 25
ME_PRED_SET_INV	= 26
ME_PRED_SET_POP	= 27
ME_PRED_SET_RESTORE	= 28

DEST REG_TYPES:

PVS_DST_REG_TEMPORARY	= 0; //Intermediate storage
PVS_DST_REG_A0	= 1; //Address Register Storage
PVS_DST_REG_OUT	= 2; //Output Memory. Used for all outputs
PVS_DST_REG_OUT_REPL_X	= 3; //Output Memory & Replicate X to all channels
PVS_DST_REG_ALT_TEMPORARY	= 4; //Alternate Intermediate Storage
PVS_DST_REG_INPUT	= 5; //Output Memory & Replicate X to all channels

The PVS_REG_A0 may only be used as the destination operand register type when using the VE_FLT2FIX_DX or the VE_FLT2FIX_DX_RND opcodes.

For R300, PVS_REG_OUT_* is replaced by the single PVS_REG_OUT and the PVS_DST_OFFSET field will be used to place data in the appropriate vectors. This allows the PVS Output Vertex memories to be variable format for the variable vertex methodology. The PVS_REG_OUT_REPL_X is equivalent to PVS_REG_OUT except that it forces the X channel to be replicated onto all 4 output channels. This capability is used to allow the mapping of Point-Sprite and Discrete Fog to any output memory channel from an instruction with a unique x-channel output.

The PVS_DST_DUAL_MATH_OP bit must be set when combining Vector and Math Engine operations.

The PVS_DST_ADDR_MODE and DST_ADDR_SEL are the same as the SRC operand definitions.

The PVS_DST_OPCODE_MSB is the most significant bit of the PVS_DST_OPCODE field to be used for the math engine for dual ops. This enables math engine operations 16 through 28 to be used during dual ops.

For R5xx VS3.0, a PVS_SRC_ABS_XYZW bits enables the absolute value for the two components of the dual op math engine source vector.

7. Fragment Shaders

7.1 Introduction

This section describes the functional behavior of the Universal Shaders of on R5xx.

7.2 Instructions

There are 512 instruction slots. A program can begin execution at any address. In the absence of flow control, programs will increment the program counter after each instruction. The program counter wraps at 512 automatically, so it is valid to load shader programs which utilize the bottommost and topmost regions of the instruction store.

Each instruction can be one of four types:

US_INST_TYPE_ALU	Arithmetic and Logic Unit instruction
US_INST_TYPE_OUTPUT	Output instruction (with ALU functionality)
US_INST_TYPE_FC	Flow Control instruction
US_INST_TYPE_TEX	Texture instruction

ALU and OUTPUT instructions both have full RGB and Alpha math functionality. The only functional difference between them is that ALU instructions can set the predicate bits, and OUTPUT instructions can write to the output registers. There is no way to do both in the same instruction. Internally, the sequencer must treat instructions that have potential outputs specially for scheduling. The last executed instruction of the shader program must also be an OUTPUT instruction, even if it's not outputting anything interesting.

The first OUTPUT instruction will reserve space in the output register fifo. This space is limited, therefore issuing an OUTPUT earlier than necessary may cause threads to stall earlier than necessary. You should not set an ALU instruction as type OUTPUT unless it is actually writing to an output register, or it is the last instruction of the program.

Flow control instructions and texture instructions each have their own interpretation of the bits in the instruction word.

The active shader should reside in the range `US_CODE_RANGE.CODE_ADDR` to `US_CODE_RANGE.CODE_ADDR + US_CODE_RANGE.CODE_SIZE`, inclusive (note that `US_CODE_RANGE.CODE_SIZE` is the size of the shader program, minus one). You may setup additional shaders in advance outside of this range, but the current shader should not attempt to execute code outside of this range.

The shader has an offset, `US_CODE_OFFSET.OFFSET_ADDR`, associated with it that is added to various instruction addresses, minimizing the number of registers you may need to update when relocating a shader. Each pixel starts the shader at instruction `US_CODE_ADDR.START_ADDR + US_CODE_OFFSET.OFFSET_ADDR` (instruction addresses are always modulo 512). Execution continues until the program counter reaches `US_CODE_SIZE.END_ADDR + US_CODE_OFFSET.OFFSET_ADDR`. It does not matter how many pixels in the group are active (even none), the program will end after that instruction is executed. The instruction at the end

address must be an OUTPUT instruction (even if the output mask is zero), and should always wait for the texture unit semaphore by setting the TEX_SEM_WAIT bit (see below). At the time of termination, the contents of the output registers are sent to the render targets.

Multiple shaders can be loaded into the instruction memory. Switching between them only requires changing global registers like US_CODE_ADDR, US_CODE_RANGE, US_CODE_OFFSET, US_PIXSIZE, and US_FC_CTRL.

Updates to shader code outside the currently active program are safe, and do not stall the pipeline. If you intend to overwrite the active shader, however, the pixel shader pipe must be flushed so that pixels running the old shader get out before the update. Register writes to US_CODE_ADDR, US_CODE_RANGE, US_CODE_OFFSET, and/or US_PIXSIZE should flush the pixel shader pipe.

The US instruction and ALU constant registers cannot be written to directly, due to addressing limitations elsewhere in the pipe. A vector mechanism is provided in the GA block for writing to the US registers. Details on writing the US registers are provided toward the end of this document.

7.3 Instruction Words

US_INST_TYPE_ALU / US_INST_TYPE_OUTPUT (6 registers):

- US_CMN_INST_*
- US_ALU_RGB_ADDR_*
- US_ALU_ALPHA_ADDR_*
- US_ALU_RGB_INST_*
- US_ALU_ALPHA_INST_*
- US_ALU_RGBA_INST_*

US_INST_TYPE_FC (3 registers):

- US_CMN_INST_*
- US_FC_INST_*
- US_FC_ADDR_*

US_INST_TYPE_TEX (4 registers):

- US_CMN_INST_*
- US_TEX_INST_*
- US_TEX_ADDR_*
- US_TEX_ADDR_DXDY_*

The FC and TEX words overlap with the ALU/OUTPUT words in instruction memory. The unused memory locations for FC and TEX are ignored by US; they may be left uninitialized, or set to zero, with no ill effect. However, the driver should take care to write to all registers that are required by each instruction type.

Within US_CMN_INST_*, the fields effective for each instruction type are indicated by *s:

	ALU	OUTPUT	FC	TEX
TYPE	*	*	*	*
TEX_SEM_WAIT	*	*	*	*
RGB_PRED_SEL	*	*	*	*
RGB_PRED_INV	*	*	*	*
ALPHA_PRED_SEL	*	*		*
ALPHA_PRED_INV	*	*		*

WRITE_INACTIVE	*	*		*
LAST	*	*	*	*
NOP	*	*		
RGB_WMASK	*	*		*
ALPHA_WMASK	*	*		*
RGB_OMASK	*	*		
ALPHA_OMASK	*	*		
RGB_CLAMP	*	*		
ALPHA_CLAMP	*	*		
ALU_RESULT_SEL	*	*		
ALU_RESULT_OP	*	*		
ALU_WAIT			*	*
STAT_WE	*	*		*

7.3.1 Synchronization of instruction streams

The US allows you to freely intermix instructions of multiple types. It will process the three types (ALU/Output, Texture, and FC) in parallel whenever possible. Instructions need to be synchronized when an instruction of one type depends on the output of another type. The cases where explicit synchronization may be required are:

- TEX instruction dependent on ALU for source register or predicate. Synchronized with the ALU_WAIT bit.
- FC instruction dependent on ALU for predicate or ALU result. Synchronized with the ALU_WAIT bit.
- ALU instruction dependent on TEX for lookup result. Synchronized using the texture semaphore.

A texture or FC instruction that uses a result computed by a prior ALU instruction should set the ALU_WAIT bit. This forces processing for the thread to stall until pending ALU instructions are complete. A latency of about 30 cycles is imposed on the thread.

Note that a static FC instruction never needs to set ALU_WAIT since it never depends on a result computed within the shader. Also, an ALU instruction never needs to set ALU_WAIT -- dependencies amongst ALU instructions are resolved internally.

The texture semaphore is used to synchronize the output of a texture instruction with a subsequent ALU or texture instruction that uses that result. Since the latency for a texture fetch is difficult to anticipate in advance, the texture semaphore mechanism is more complex than ALU_WAIT. The texture semaphore is described in more detail below.

7.4 ALU Instructions

An ALU instruction actually consists of an RGB vector instruction and an Alpha scalar instruction.

There are only a few operations that only one or the other unit can compute, but in each case there is a special instruction the other engine can use to copy the result.

7.4.1 Sources

Each instruction can specify the addresses for 6 different sources – 3 RGB vectors and 3 Alpha scalars. Each source can either come from one of 128 temporary registers (which can be modified during the shader, and be different for each pixel), or from one of 256 constant registers (which can only be changed between geometry packets). In addition, a source can be an inline constant. The loop variable (aL) may be added to any combination of source addresses, but may not be added to an inline constant.

Each color register (temporary and constant) consists of a 3-component RGB vector and a scalar Alpha value.

Inline constants are unsigned floating-point values with 4 bits of exponent (with bias 7) and 3 bits mantissa. Inline constants represent finite values only -- there is no representation for NaN or infinity. Inline constants can express denormal values though. Also, the bit pattern 0x0 represents 2^{-10} , rather than zero. Example values are shown below:

	EXPONENT	MANTISSA
2^{-10}	0x0	0x0
2^{-9}	0x0	0x1
2^{-8}	0x0	0x2
2^{-7}	0x1	0x4
2^{-6}	0x7	0x0
1	0xf	0x0
256	0xf	0x0
480	0xf	0x7

You can obtain negative inline constants and the value zero using the input modifiers and swizzles, described below.

Each source is specified with three fields. Valid encodings of these fields are shown below (for source 0, in this example):

	ADDR0[7]	ADDR0[6:0]	ADDR0_CONST	ADDR0_REL
register N	0	N	0	0
register N + aL	0	N	0	1
constant N	N / 128	N % 128	1	0
constant N + aL	N / 128	N % 128	1	1
inline const X	1	X	0	0

Note that inline constants set the MSB of ADDR0 and clear ADDR0_CONST.

7.4.2 Presubtract

Each RGB and Alpha instruction has a presubtract operation, which does some extra math on incoming data from the first or from the first and second sources. The available operations are:

US_SRCOP_OP_BIAS	$1 - 2 * \text{src0}$
US_SRCOP_OP_SUB	$\text{src1} - \text{src0}$
US_SRCOP_OP_ADD	$\text{src1} + \text{src0}$
US_SRCOP_OP_INV	$1 - \text{src0}$

The RGB presubtract happens on all three components in parallel. The Alpha presubtract is scalar.

If any presubtract result is used in the instruction, and one of the sources being used in a presubtract is written in the previous instruction, and the previous instruction is an ALU or output instruction, a NOP needs to be inserted between the two instructions. Do this by setting the NOP flag in the previous instruction, so the NOP does not consume an instruction slot. This allows the HW the extra cycle necessary to resolve the dependencies involved in doing this extra math (there are additional cases where NOP may need to be set, noted below).

NOP is never required if the previous instruction is a texture lookup.

7.4.3 *Inputs*

Each math operation has zero to three inputs. Each input can be configured to select a source and swizzle its channels. There are fields to configure 6 inputs per instruction: 3 for RGB and 3 for Alpha. An instruction can read in at most 12 independent colour components (9 RGB components and 3 alpha components).

7.4.3.1 *Select*

Each input selects from src0, src1, src2, or the presubtract result ("srcp"). One can conceive of the selects assembling a 4-component vector as seen below. The swizzle selects (see next section) determine which of the four values are chosen to actually take part in the computations.

```

src0 = { rgb_addr0->r
        { rgb_addr0->g
        { rgb_addr0->b
        { alpha_addr0->a

src1 = { rgb_addr1->r
        { rgb_addr1->g
        { rgb_addr1->b
        { alpha_addr1->a

src2 = { rgb_addr2->r
        { rgb_addr2->g
        { rgb_addr2->b
        { alpha_addr2->a

srcp = { rgb_srcp_result.r = rgb_srcp_op(rgb_addr0->r, rgb_addr1->r)
        { rgb_srcp_result.g = rgb_srcp_op(rgb_addr0->g, rgb_addr1->g)
        { rgb_srcp_result.b = rgb_srcp_op(rgb_addr0->b, rgb_addr1->b)
        { alpha_srcp_result.a = alpha_srcp_op(alpha_addr0->a, alpha_addr1->a)

```

The RGB and alpha units each take three operands, A, B, and C. These operands are selected with the RGB_SEL_x and ALPHA_SEL_x fields. Note that src0, src1 and src2 are fetched from a combination of the RGB and alpha source addresses. If the RGB unit swizzles in an alpha component, the alpha component will always come from alpha_addr*. Similarly, if the alpha unit swizzles in an RGB component, it will always come from rgb_addr*.

7.4.3.2 *Swizzle*

Each component of each input can specify one of seven values. Each component can select R, G, B, or A from the selected source, or it can choose 0, 0.5, or 1. The RGB unit has 3 components, so there are three swizzle select fields per input. The Alpha unit only has 1 swizzle select per input.

The RGB unit always uses the RGB selectors (RGB_SEL_x) and, except for one case noted below, the red (RED_SWIZ_x), green (GREEN_SWIZ_x), and blue (BLUE_SWIZ_x) swizzle selects. The alpha unit always uses the alpha selectors (ALPHA_SEL_x) and the alpha (ALPHA_SWIZ_x) swizzle selects.

DP4 is a special case in that it is an RGB operation which operates on 4 components instead of 3. The fourth input component is configured with the Alpha's select (ALPHA_SEL_x) and swizzle (ALPHA_SWIZ_x). This is the only case where the Alpha's swizzle has an effect on the RGB computation's input.

7.4.3.3 Input Modifier

Each input has a modifier applied to it. The modifier can be one of:

US_IMOD_OFF	No modification
US_IMOD_NEG	Negate
US_IMOD_ABS	Take absolute value
US_IMOD_NAB	Take negative of absolute value

7.4.4 The Operation

Following are the possible math operations the ALU can perform. The three inputs are denoted by A, B, and C.

US_OP_RGB_SOP / US_OP_ALPHA_DP	Get results from the other unit's unique ops. In the case of RGB_SOP, the result is replicated to all three channels. RGB's unique ops all have scalar results, so ALPHA_DP simply copies that scalar result to its alpha destination. RGB_SOP is only valid if the alpha operation is a transcendental operation: EX2, LN2, RCP, RSQ, SIN, COS. ALPHA_DP is only valid if the RGB operation is a dot product: DP3, DP4, D2A.
US_OP_RGB_MAD / US_OP_ALPHA_MAD	$A * B + C$
US_OP_RGB_MIN / US_OP_ALPHA_MIN	$A < B ? A : B$ Minimum of A and B.
US_OP_RGB_MAX / US_OP_ALPHA_MAX	$A >= B ? A : B$ Maximum of A and B.
US_OP_RGB_CND / US_OP_ALPHA_CND	$C > 0.5 ? A : B$
US_OP_RGB_CMP / US_OP_ALPHA_CMP	$C >= 0 ? A : B$
US_OP_RGB_FRC / US_OP_ALPHA_FRC	$A - \text{floor}(A)$ floor(A) is the largest integer value less than or equal to A.
US_OP_RGB_MDH / US_OP_ALPHA_MDH	$A * B + C$ Where: A is forced to topleft.src0 (source select and swizzles ignored)

	<p>C is forced to topright.src0 (source select and swizzles ignored)</p> <p>MDH operates on a quad of pixels at a time; A and C will be the same value for each pixel within a quad, and the result will also be the same if B is a constant value.</p> <p>Used to computes change in horizontal direction between neighboring pixels. For example, to get the difference (topright.r0 - topleft.r0) set: src0 = r0 B = -1 Note that input modifiers work on all three inputs.</p> <p>If src0 is computed in the previous instruction, then a NOP needs to be inserted between the two instructions. Do this by setting the NOP flag in the previous instruction. This is not required if the previous instruction is a texture lookup.</p>
US_OP_RGB_MDV / US_OP_ALPHA_MDV	<p>$A * B + C$ Where: A is forced to topleft.src0 (source select and swizzles ignored) C is forced to bottomleft.src0 (source select and swizzles ignored)</p> <p>MDV operates on a quad of pixels at a time; A and C will be the same value for each pixel within a quad, and the result will also be the same if B is a constant value.</p> <p>Used to computes change in vertical direction between neighboring pixels. For example, to get the difference (bottomleft.r0 - topleft.r0) set: src0 = r0 B = -1 Note that input modifiers work on all three inputs.</p> <p>If src0 is computed in the previous instruction, then a NOP needs to be inserted between the two instructions. Do this by setting the NOP flag in the previous instruction. This is not required if the previous instruction is a texture lookup.</p>
US_OP_RGB_DP3	<p>$A.r*B.r + A.g*B.g + A.b*B.b$ Results are broadcast to all 3 channels. Use US_OP_ALPHA_DP to get result into Alpha.</p>
US_OP_RGB_DP4	<p>$A.r*B.r + A.g*B.g + A.b*B.b + A.a*B.a$ Results are broadcast to all 3 channels. Use US_OP_ALPHA_DP to get result into Alpha. Note that ".a" actually comes from the alpha instruction's swizzle and select (see the section on swizzle above).</p>
US_OP_RGB_D2A	<p>$A.r*B.r + A.g*B.g + C.b$ Results are broadcast to all 3 channels. Use US_OP_ALPHA_DP to get result into Alpha.</p>
US_OP_ALPHA_EX2	<p>$2 \wedge A$</p>

	Use US_OP_RGB_SOP to get result into RGB.
US_OP_ALPHA_LN2	$\log_2(A)$ Use US_OP_RGB_SOP to get result into RGB.
US_OP_ALPHA_RCP	$1 / A$ Use US_OP_RGB_SOP to get result into RGB.
US_OP_ALPHA_RSQ	$1 / \text{squareRoot}(A)$ Use US_OP_RGB_SOP to get result into RGB. Note that the SM3 specification defines reciprocal square root as $1 / \text{squareRoot}(\text{abs}(A))$ -- this can be achieved by using the input modifier for A.
US_OP_ALPHA_SIN	$\sin(A * 2\pi)$ Use US_OP_RGB_SOP to get result into RGB.
US_OP_ALPHA_COS	$\cos(A * 2\pi)$ Use US_OP_RGB_SOP to get result into RGB.

7.4.5 Instruction modifiers

Each instruction can have an output modifier applied to its result:

US_OMOD_U1	Multiply by 1
US_OMOD_U2	Multiply by 2
US_OMOD_U4	Multiply by 4
US_OMOD_U8	Multiply by 8
US_OMOD_D2	Divide by 2
US_OMOD_D4	Divide by 4
US_OMOD_D8	Divide by 8
US_OMOD_DISABLED	No modification

Each instruction can also be optionally clamped to the range 0 to 1. This happens after the above output modifier.

7.4.5.1 *Disabling the output modifier*

The multiply/divide output modifiers all convert NaN values into a standardized NaN (0x7fffffff) and squash any denormal values to plus or minus zero. For most ALU operations this is acceptable, however a MOV instruction needs to preserve the source exactly. For this, you can disable the output modifier for the MIN, MAX, CMP and CND instructions. With US_OMOD_DISABLED, the result is not modified at all; the value is neither multiplied nor divided, and clamping is not applied.

This allows a MOV to be implemented using any of the following instructions, with US_OMOD_DISABLED set:

```
MIN(src, src)
MAX(src, src)
CND(src, src, 0)
CMP(src, src, 0)
```

US_OMOD_DISABLED is not valid with any other ALU operation.

7.4.6 Writemasks

There are a number of writemasks for each instruction:

RGB_WMASK	3 bits; write R,G,B to register destination.
ALPHA_WMASK	1 bit; write A to register destination.
RGB_OMASK	bits; write R,G,B to output or to predicate bits.
ALPHA_OMASK	1 bit; write A to output or to predicate bits.
W_OMASK	1 bit; write A to W output.
WRITE_INACTIVE	1 bit; if set, ignores flow control pixel mask when writing. Affects ALU and texture instructions. If in doubt, this bit should be cleared.
STAT_WE	4 bits; Mask R,G,B,A to increment sign-count performance counter.
RGB_PRED_SEL	3 bits; Sets one of six modes that specify which of the 4 predicate bit(s) to AND with the RGB writemask (and output mask when applicable). One of: NONE - no predication RGBA - normal predication RRRR - replicate R predicate bit GGGG - replicate G predicate bit BBBB - replicate B predicate bit AAAA - replicate A predicate bit
RGB_PRED_INV	1 bit; Inverts selected RGB predicate bit(s). Should be zero if RGB_PRED_SEL is set to NONE.
ALPHA_PRED_SEL	3 bits; like RGB_PRED_SEL, but used to control predication for the alpha unit's write mask.
ALPHA_PRED_INV	1 bit; Inverts selected alpha unit predicate bit. Should be zero if ALPHA_PRED_SEL is set to NONE.
IGNORE_UNCOVERED	1 bit; if set, excludes uncovered pixels (outside triangle or killed via TEXKILL) from TEX lookups and flow control decisions. Affects texture and flow control instructions. If in doubt, this bit should be cleared.
ALU_WMASK	1 bit; if set, update the ALU result. Similar to the predicate write mask.

Flow control instructions only have one predicate select, using the RGB_PRED_SEL and RGB_PRED_INV fields. ALU/Output instructions can use different predicate selects for the RGB (vector) computation and the alpha (scalar) computation. For texture instructions, the RGB results from the texture unit will be influenced by RGB_PRED_SEL/RGB_PRED_INV, and the alpha result from the texture unit will be influenced by the ALPHA_PRED_SEL/ALPHA_PRED_INV fields.

7.4.7 Destination

The destination address refers to a temporary register. The loop variable (aL) may optionally be added to the address before writing. The predicate select in RGB_PRED_SEL, RGB_PRED_INV, ALPHA_PRED_SEL, and ALPHA_PRED_INV will be applied when writing to the destination.

7.4.8 Output

With OUTPUT instructions, the TARGET field indicates where the result of the instruction should be written. When in cached write mode (the default mode), the following options are available:

US_RNDR_TGT_A	Write to render target A register
US_RNDR_TGT_B	Write to render target B register
US_RNDR_TGT_C	Write to render target C register
US_RNDR_TGT_D	Write to render target D register

The US_OUT_FMT_* registers describe render targets A through D. The results are stored and the final value is sent out when the program terminates. If a channel in an output target is written more than once, the final value written is what will be sent out. The RGB and alpha unit may write to different targets in the same instruction.

The output may be predicated using PRED_SEL and PRED_INV.

7.4.9 Setting Predicate Bits

Each instruction may optionally set one or more predicate bits. ALU instructions (as opposed to OUTPUT instructions) interpret the OMASK fields as a predicate writemask. The TARGET field determines when to set the bits associated with each channel:

US_PRED_OP_EQUAL	Set when channel is zero
US_PRED_OP_LESS	Set when channel is negative
US_PRED_OP_GREATER_EQUAL	Set when channel is non-negative
US_PRED_OP_NOT_EQUAL	Set when channel is non-zero

The enumeration's names are based on the assumption that they will be primarily used after a subtraction of two values. That's not the only possible use, of course. The RGB and alpha units may use different functions to set the predicate in the same instruction.

In order to achieve the remaining common comparisons, <= and >, one can simply reverse the order of the values being subtracted, or reverse both signs, and use the >= and < operations respectively.

You can simultaneously write to the predicate register and a temporary register, and you can perform a predicated temporary register write if you are also writing the predicate register. However, the old value of the predicate will only be applied to the temporary register's write mask; it will not be applied to the predicate write mask. In other words, if the predicate is 0x7, your temporary write mask is 0xf and your predicate write mask is 0xf, you will write only RGB components to the temporary register, but you will write to all 4 predicate bits.

If the instruction result is clamped, the comparison happens on the post-clamped result. If output modifier is disabled, denormals may be compared -- denormals are equivalent to zero.

7.4.10 ALU Result

Every instruction has an "ALU result." In order to use it, an ALU instruction must write an ALU result, and a it must be consumed by the next flow control instruction. The ALU result is preserved across other ALU/texture

instructions that do not write a new ALU result, but is NOT preserved across flow control instructions; therefore the ALU result must be consumed by the first flow control statement after it is written.

The ALU result is a single bit. The channel source for the ALU result is selected by the ALU_RESULT_SEL field:

US_ALU_RESULT_SEL_RED
US_ALU_RESULT_SEL_ALPHA

How to interpret the floating point result to set the ALU result bit is specified by the ALU_RESULT_OP field, which is similar to the interpretation of the TARGET field for setting the predicate bits:

US_ALU_RESULT_OP_EQUAL	Set when channel is zero
US_ALU_RESULT_OP_LESS	Set when channel is negative
US_ALU_RESULT_OP_GREATER_EQUAL	Set when channel is non-negative
US_ALU_RESULT_OP_NOT_EQUAL	Set when channel is non-zero

The ALU instruction that updates the ALU result must set the ALU_WMASK bit.

If the instruction result is clamped, the comparison happens on the post-clamped result. If output modifier is disabled, denormals may be compared -- denormals are equivalent to zero.

7.5 Texture Instructions

Texture instructions are simpler than ALU or flow control instructions. Texture instructions have one destination temporary address, 1 to 3 source temporary addresses, a sampler ID, and an opcode and control bits specifying how to lookup the texture. Most texture configuration is handled in the per-sampler configuration.

As with ALU temporary addresses, the loop variable (aL) may be added to any texture temporary address (source and destination). Texture source addresses allow arbitrary swizzles from RGBA to STRQ coordinate space, and the RGBA result from the texture unit may also be swizzled. Unlike with ALU instructions, the texture swizzles cannot be used to select constant inputs (0, 0.5, 1). Texture source addresses always read from the temporary registers; they cannot read from the constant bank.

Texture instructions feature a texture semaphore mechanism to synchronize texture lookup with instructions using the result of the lookup. See below for more information.

You may choose to limit which channels of a texture lookup are written by using the write masks RGB_WMASK and ALPHA_WMASK. These write masks may be predicated; the RGB results from the texture unit are predicated with RGB_PRED_SEL and RGB_PRED_INV, while the alpha result from the texture unit is predicated with ALPHA_PRED_SEL and ALPHA_PRED_INV.

Texture instructions have an UNSCALED bit that to control whether the texture coordinates are scaled by the texture dimensions before lookup. In typical usage, this bit is cleared for normal texture lookups which supply coordinates in the range [0.0, 1.0], and set for texture lookups which supply coordinates that are prescaled to the texture dimensions.

7.5.1 Operations

There are currently 7 texture operations available.

US_TEX_INST_NOP	Perform no operation. The source addresses are ignored, and nothing is written to the destination address. A texture NOP may acquire the texture semaphore, so NOP can be used for synchronization purposes.
US_TEX_INST_LOOKUP	A standard texture lookup. Reads the coordinates from SRC_ADDR and writes the results of the lookup to DST_ADDR.
US_TEX_INST_KILL_LT_0	Kill the pixel if any components in SRC_ADDR are less than zero. Note that the source swizzles are ignored in this case; if you want to limit which channels are examined, you may use the write masks in WMASK_RGB, WMASK_ALPHA, and/or predication. Nothing is written to the destination address, but the coverage mask may be updated.
US_TEX_INST_LOOKUP_PROJ	Lookup a projected texture. Q is used for the projective divide.
US_TEX_INST_LOOKUP_LODBIAS	Lookup a texture, biasing the LOD that is computed.
US_TEX_INST_LOOKUP_LOD	Lookup a texture, using the value specified in the Q coordinate of the input as an explicit LOD value.
US_TEX_INST_LOOKUP_DX DY	Lookup a texture, computing a LOD based on slopes given. This is the only opcode that uses the DX_ADDR and DY_ADDR source addresses. These registers contain the slope values the texture unit should use when determining the slope.

7.5.2 Semaphore

The semaphore is used to synchronize texture lookups with their subsequent use in the shader program.

Each texture instruction has a bit, TEX_SEM_ACQUIRE, specifying whether it should hold the texture semaphore until the looked-up data comes back and is written to the destination temporary register. All shader instructions have another semaphore bit, TEX_SEM_WAIT, that specifies whether to wait on the semaphore so its (dependent) source data is up to date. You may take advantage of the texture semaphore to perform various independent computations while waiting on the texture operation to complete.

Hardware disallows more than one ACQUIRE operation at a time, so if you set TEX_SEM_ACQUIRE on a lookup, you must also set TEX_SEM_WAIT for that instruction. WAIT has no cost if there are no outstanding ACQUIRE operations. For an instruction with TEX_SEM_WAIT and TEX_SEM_ACQUIRE both set, the wait happens first.

There is only one texture semaphore, however you may use it to protect multiple texture lookups, as long as the lookups are themselves independent. When a texture instruction sets TEX_SEM_ACQUIRE, the texture unit ensures that that particular lookup, and all prior lookups, have completed before releasing the semaphore. Therefore, to protect several texture lookups, you may set TEX_SEM_ACQUIRE only on the last texture lookup, and set TEX_SEM_WAIT on the first instruction that uses any of the results. This example illustrates the usage:

	INSTRUCTION	TEX_SEM_WAIT	TEX_SEM_AQUIRE
0:	r4 = TEXLD(s0, r1)	0	0
1:	r5 = TEXLD(s1, r2)	0	0
2:	r6 = TEXLD(s2, r3)	1	1

3:	$r1 = r1 + 1$	0	
4:	$r2 = r2 + 1$	0	
5:	$r3 = r3 + 1$	0	
6:	$r4 = r4 + 1$	1	

In the above example, note that instruction 2 waits for the semaphore to ensure the semaphore is available before acquiring it.

Remember that the last instruction of the shader program must set `TEX_SEM_WAIT`, to ensure that the texture unit is ready to process the next quad. It is invalid to terminate the shader while holding the texture semaphore from a texture lookup.

7.6 Flow Control

Each flow control instruction is essentially a conditional jump. Various optional stack operations allow all the different kinds of traditional flow control statements. In particular, flow control instructions allow branch statements (if/else/endif blocks), loop statements (with an optional loop register, `aL`), and subroutine calls. Optimizers may be able to combine these basic types of instructions, and utilize more esoteric flow control modes.

HW supports two flow control modes, "partial" and "full". Partial flow control mode enables twice as many contexts as full mode, but partial flow control mode has a limited nesting depth of branch statements, and does not support loops or subroutine calls. Partial flow control mode should be used unless the program requires branch statements nested more than 6 deep, or the program requires loops or subroutines. If full flow control mode is used, then your shader must declare at least two temporary registers (the `US_PIXSIZE.PIXSIZE` field must be greater than or equal to 1). The `US_FC_CTRL` register, described below, controls the behaviour of all flow control statements in a program including whether to use partial or full flow control mode.

See the Fields section below for descriptions of fields that affect the jump condition and the various flow control stacks. Following that are the values of those fields for the most common types of flow control operations.

7.6.1 *Dynamic Flow Control*

As the US is a SIMD engine, applying the same instruction to a group of pixels, dynamic flow control must be implemented with pixel masks. If a pixel wants to take a jump because it failed an IF condition, but its neighbors in the pixel group don't want to jump, the pixel must be masked off for a time until that branch of the IF statement is completed. Only if all pixels fail the IF condition would the program counter actually be changed. Conversely, if some pixels don't want to jump to a subroutine, they must be masked off for the entire subroutine. Only if none of the pixels want to jump would the call be skipped. A break statement within a loop masks off passing pixels until the loop is complete, and the program counter is only changed if all pixels want to jump.

These pixel masks are organized into stacks so flow control blocks may be nested. The operations on these stacks are encoded in the flow control instructions as flags, instead of having one set of opcodes which hard-wire the stack behavior. This orthogonality allows for more creative control of the shader's behavior, and provides opportunity for optimizations in shaders that use a lot of flow control.

Jump conditions can be based off of a boolean constant, the result of the previous ALU operation, and/or a predicate bit. Booleans are constant across all pixels, so dynamic flow control is only achieved with predicates and conditionals (ALU result). Any ALU instruction can specify whether to write the ALU result and what channel supplies the data for the result. The ALU result is only valid until another ALU instruction writes to the result, or a

flow control instruction is encountered. The predicate bits can be set anywhere and are preserved across flow control instructions, but there are only 4 of them.

Flow control predication cannot be per-channel. One of the replicate swizzles must be used for predication of flow control instructions (all other types of instructions can be predicated per channel). Flow control instructions use the RGB_PRED_SEL and RGB_PRED_INV fields to compute the predicate.

7.6.2 The Stacks, and Branch Counters

The HW maintains two separate stacks for flow control.

Address Stack	Purely an address stack. No other state is maintained. Popping the address stack overrides the instruction address field of the flow control instruction. The address stack will only be modified if the flow control instruction decides to jump.
Loop Stack	Stores an internal iteration count, loop variable (aL), and a pixel mask per frame. The only way to access the iteration count is with the LOOP/ENDLOOP and REP/ENDREP operations. The only way to alter the aL variable is with the LOOP/ENDLOOP ops. The only way to read the aL variable is with relative addressing. The only way to alter the pixel mask is with the BREAK or CONTINUE instruction.

Each stack's size is dependent on whether the program is in partial or full flow control mode. Stack overflows and underflows produce undefined behaviour in the hardware. The stack sizes are:

	PARTIAL	FULL
Loop stack	n/a	4
Address stack	n/a	4

The loop stack is maintained in such a way that an inner REP block will continue to see the loop variable from an outer LOOP block. Nested LOOP blocks will shadow the loop variable. The loop variable is not valid if you are not in at least one LOOP block.

In addition to the two stacks, hardware maintains an Active Bit and a Branch Counter for each pixel that indicate whether the pixel is active and, if it was disabled by a conditional statement (if, else), how long before it can be reactivated. If the active bit is unset, the pixel is inactive and the branch counter indicates the number of conditional blocks we must exit before the pixel can be activated again. The maximum value of this counter is dependent on whether the program is in partial or full flow control mode. The limits (which determine maximum safe nesting depth) are:

	PARTIAL	FULL
Branch counter	0..3	0..31
Maximum depth	4	32

The branch counter can be incremented and decremented directly by any flow control instruction based on whether the pixel agrees with the jump decision. Manipulating the branch counter may affect the active bit. Incrementing the counter on an active pixel will disable the pixel by clearing the active bit, and set the branch counter to zero. Decrementing the counter of an inactive pixel to a negative value will set the active bit, reactivating the pixel. The branch counter is ignored in hardware while the active bit is set.

Pixels disabled by looping statements (BREAKLOOP, BREAKREP, and CONTINUE) are also tracked with "loop inactive" counters, however unlike the branch counter, the loop counters cannot be manipulated directly.

Since only conditional (if, else) and loop statements maintain active pixel masks, to call a function based on a condition requires the shader to use the branch counters on CALL and RETURN so the pixel active mask will be updated on the conditional call. If you know ahead of time that *all* calls to a particular subroutine will be unconditional calls, you can omit the branch counter manipulation on that subroutine's return and on any calls to that subroutine. The benefit of this is unclear, unless you are nearing the upper limit on the branch counter.

Returns within dynamic branches and/or loops (nested in the subroutine) are not supported. A return can be made conditional (by incrementing the branch stack counter on stay), but the hardware does not support returning within other conditional blocks that might partially mask it. If a branch is entirely static (based on a constant boolean), you may put a return within a branch (just get the branch counter decrement right). This cannot be done inside loops, however.

7.6.3 *Fields*

7.6.3.1 *Fields controlling conditions on the jump*

JUMP_FUNC	2x2x2 table indicating when to jump
Bit 0	= Jump when (!alu_result && !predicate && !boolean).
Bit 1	= Jump when (!alu_result && !predicate && boolean).
Bit 2	= Jump when (!alu_result && predicate && !boolean).
Bit 3	= Jump when (!alu_result && predicate && boolean).
Bit 4	= Jump when (alu_result && !predicate && !boolean).
Bit 5	= Jump when (alu_result && !predicate && boolean).
Bit 6	= Jump when (alu_result && predicate && !boolean).
Bit 7	= Jump when (alu_result && predicate && boolean).

Common JUMP_FUNC values:

0x00	= Never jump
0x0f	= Jump iff alu_result is false.
0x33	= Jump iff predicate is false.
0x55	= Jump iff boolean is false.
0xaa	= Jump iff boolean is true.
0xcc	= Jump iff predicate is true.
0xf0	= Jump iff alu_result is true.
0xff	= Always jump

JUMP_ANY	How to treat partially passing groups of pixels
false	= Don't jump unless all pixels want to jump.

true	= Jump if at least one active pixel wants to jump.
------	--

When JUMP_ANY is false, the instruction behaves like a universal quantifier, and will decide jump if there are no active pixels. When JUMP_ANY is true, the instruction behaves like an existential quantifier, and will never decide to jump if there are no active pixels. Looping statements may override the jump decision made by the pixels based on the loop counter.

7.6.3.2 Fields controlling optional stack operation

OP	Loop Stack Operations
US_FC_OP_JUMP	None
US_FC_OP_LOOP	Initialize counter and aL, and push loop stack if stay
US_FC_OP_ENDLOOP	Increment counter and aL if jump, else pop loop stack
US_FC_OP_REP	Initialize counter, and push loop stack if stay
US_FC_OP_ENDREP	Increment counter if jump, else pop loop stack
US_FC_OP_BREAKLOOP	Pop loop stack if jump
US_FC_OP_BREAKREP	Pop loop stack if jump
US_FC_OP_CONTINUE	Disable pixels until end of current loop

You should use US_FC_OP_BREAKLOOP if the innermost looping construct is LOOP, and US_FC_OP_BREAKREP if the innermost looping construct is REP.

A_OP	Address Stack Operations
US_FC_A_OP_NONE	= None
US_FC_A_OP_POP	= Pop address stack if jump (overrides JUMP_ADDR given in instruction)
US_FC_A_OP_PUSH	= Push address stack if jump

B_OP0	Branch stack Operations if stay
US_FC_B_OP_NONE	= None
US_FC_B_OP_DECR	= Decrement branch counter for inactive pixels by amount in B_POP_CNT. Activate pixels which go negative.
US_FC_B_OP_INCR	= Increment branch counter for inactive pixels by 1. Deactivate pixels which disagree with the jump decision (by deciding to jump) and set their branch counter to 0.

B_OP1	Branch stack Operations if jump
US_FC_B_OP_NONE	= None
US_FC_B_OP_DECR	= Decrement branch counter for inactive pixels by amount in B_POP_CNT. Activate pixels which go negative.
US_FC_B_OP_INCR	= Increment branch counter for inactive pixels by 1. Deactivate pixels which disagree with the jump decision (by deciding not to jump) and set their branch counter to 0.

B_POP_CNT	Branch Stack Pop Count
How much to decrement the branch counters by when appropriate B_OP* field says to decrement.	

B_ELSE	Branch Stack Else
false	= None
true	= Activate pixels whose branch count is zero (pixels deactivated by the innermost conditional block), and deactivate all pixels that were active.

Special Cases:

- When the iteration count is zero, LOOP/REP ignore JUMP_FUNC and jump.
- When the iteration count is zero, ENDLOOP/ENDREP ignore JUMP_FUNC and don't jump.
- Any pixels deactivated by B_ELSE "want to jump" regardless of JUMP_FUNC.
- Any pixels deactivated by a branching statement (if, else) will inhibit a decision to jump by a BREAK or CONTINUE statement.
- Any pixels deactivated by a CONTINUE statement will inhibit a decision to jump by a BREAK statement; they will not inhibit a decision to jump by another CONTINUE statement.
- Pixels deactivated by other flow control are indifferent to the decision to jump by a BREAK or CONTINUE statement.

7.6.3.3 Address Fields

BOOL_ADDR	Which of 32 constant booleans to use for jump condition
INT_ADDR	Which of 32 constant integers to use for loop initialization (the red channel is used for iteration count, green for aL initialization, and blue for aL increment)
JUMP_ADDR	Which instruction to jump to if conditions pass
JUMP_GLOBAL	Whether JUMP_ADDR is global, or if OFFSET_ADDR should be added to JUMP_ADDR.

7.6.3.4 Global Configuration

FULL_FC_EN	Whether to enable full flow control support.
false	= No loops or calls, limited branching. Better performance.
true	= All flow control functionality enabled.

7.6.4 Common Flow Control Statements

	JUMP_FUNC	JUMP_ANY	OP	A_OP	B_OP0	B_OP1	B_POP_CNT	B_ELSE	JUMP_ADDR
IF b	0x55	0	JUMP	NONE	NONE	NONE	0	0	ELSE+1
ELSE	0xff	0	JUMP	NONE	NONE	NONE	0	0	ENDIF
ENDIF									
IF p	0x33	0	JUMP	NONE	INCR	INCR	0	0	ELSE+1
ELSE	0x00	0	JUMP	NONE	NONE	DECR	1	1	ENDIF+1
ENDIF	0x00	1	JUMP	NONE	DECR	NONE	1	0	0
IF c	0x0f	0	JUMP	NONE	INCR	INCR	0	0	ELSE+1
ELSE	0x00	0	JUMP	NONE	NONE	DECR	1	1	ENDIF+1
ENDIF	0x00	1	JUMP	NONE	DECR	NONE	1	0	0
IF b	0x55	0	JUMP	NONE	NONE	NONE	0	0	ENDIF

ENDIF									
IF p	0x33	0	JUMP	NONE	INCR	NONE	0	0	ENDIF+1
ENDIF	0x00	1	JUMP	NONE	DECR	NONE	1	0	0
IF c	0x0f	0	JUMP	NONE	INCR	NONE	0	0	ENDIF+1
ENDIF	0x00	1	JUMP	NONE	DECR	NONE	1	0	0
LOOP	0x00	0	LOOP	NONE	NONE	NONE	0	0	ENDLOOP+1
ENDLOOP	0xff	1	ENDLOOP	NONE	NONE	NONE	0	0	LOOP+1
REP	0x00	0	REP	NONE	NONE	NONE	0	0	ENDREP+1
ENDREP	0xff	1	ENDREP	NONE	NONE	NONE	0	0	REP+1
BREAK	0xff	0	BREAK	NONE	NONE	DECR	n	0	END+1
BREAK b	0xaa	0	BREAK	NONE	NONE	DECR	n	0	END+1
BREAK p	0xcc	0	BREAK	NONE	NONE	DECR	n	0	END+1
BREAK c	0xf0	0	BREAK	NONE	NONE	DECR	n	0	END+1
CONTINUE	0xff	0	CONTINUE	NONE	NONE	DECR	n	0	END
CONTINUE b	0xaa	0	CONTINUE	NONE	NONE	DECR	n	0	END
CONTINUE p	0xcc	0	CONTINUE	NONE	NONE	DECR	n	0	END
CONTINUE c	0xf0	0	CONTINUE	NONE	NONE	DECR	n	0	END
CALL	0xff	1	JUMP	PUSH	NONE	INCR	0	0	Subroutine
CALL b	0xaa	1	JUMP	PUSH	NONE	INCR	0	0	Subroutine
CALL p	0xcc	1	JUMP	PUSH	NONE	INCR	0	0	Subroutine
CALL c	0xf0	1	JUMP	PUSH	NONE	INCR	0	0	Subroutine
RETURN	0xff	0	JUMP	POP	NONE	DECR	1	0	0

* n indicates how many branch stack frames the BREAK is inside within the current loop.

* Lines with no fields filled out indicate no FC instruction is necessary in that spot.

7.6.5 Optimizations

Clearly, not all the possible combinations are explored above. The flexibility of the flow control instruction allows for more creative flow control operations, or (more likely) optimizations.

One of the easiest optimizations makes use of the B_POP_CNT to merge consecutive ENDIF statements:

	JUMP_FUNC	JUMP_ANY	OP	A_OP	B_OP0	B_OP1	B_POP_CNT	B_ELSE	JUMP_ADDR
IF c	0x0f	0	JUMP	NONE	INCR	NONE	0	0	ENDIF_0+1
[...]									
IF c	0x0f	0	JUMP	NONE	INCR	NONE	0	0	ENDIF_1+1
[...]									
IF c	0x0f	0	JUMP	NONE	INCR	NONE	0	0	ENDIF_2+1
[...]									
ENDIF	0x00	1	JUMP	NONE	DECR	NONE	1	0	0
ENDIF	0x00	1	JUMP	NONE	DECR	NONE	1	0	0
ENDIF	0x00	1	JUMP	NONE	DECR	NONE	1	0	0

Becomes:

	JUMP_FUNC	JUMP_ANY	OP	A_OP	B_OP0	B_OP1	B_POP_CNT	B_ELSE	JUMP_ADDR
IF c	0x0f	0	JUMP	NONE	INCR	NONE	0	0	ENDIF+1

[...]									
IF c	0x0f	0	JUMP	NONE	INCR	DECR	1	0	ENDIF+1
[...]									
IF c	0x0f	0	JUMP	NONE	INCR	DECR	2	0	ENDIF+1
[...]									
ENDIF									
ENDIF									
ENDIF	0x00	1	JUMP	NONE	DECR	NONE	3	0	0

7.6.6 LAST Bit

The LAST bit in the US_CMN_INST instruction word allows shaders to terminate before reaching the address indicated by US_CODE_SIZE.END_ADDR. The LAST bit can be indicated for any instruction type. Any active pixel for an instruction of any type (FC, ALU, OUTPUT or TEX) marked "last" will be considered "done" for that instruction and all future instructions that the shader might execute for that thread. Future instructions may or may not be executed, according to the hardware implementation.

In the R5xx hardware implementation, when all pixels are "done" in a thread and we hit an OUTPUT instruction that is marked as "last" (and has a texture semaphore wait! -- this is required), we will stop the thread, even if this isn't the instruction specified by END_ADDR. Also, pixels that are "done" behave the same as pixels considered "inactive" when encountering flow control instructions, meaning that code that would have been skipped over if all pixels were "inactive" would also be skipped over if the only pixels marked as "active" were also marked as "done."

7.7 Floating Point Issues

The US is designed to be compliant with the Shader Model 3, which does not officially support IEEE special values (denormal, infinity, NaN), and allows for leniency in various corner cases.

The US strives to provide a more complete IEEE floating point implementation. US supports the IEEE 32-bit floating point format, with 23 bits mantissa, 8 bits biased exponent (bias 127), and 1 bit sign. The US also supports the special IEEE values (denormal, infinity, NaN), but there are some important caveats in the implementation which are noted below. There is no distinction between an sNaN and a qNaN.

7.7.1 Deviations from IEEE

The most pervasive caveat is that denormals are flushed to an appropriately signed zero throughout US. There is no gradual underflow, and identities are not preserved for denormal values. This will be apparent in comparison operations where a denormal is treated as equivalent to zero.

Also pervasive, the internal rounding mode is not configurable and is not exact to the IEEE standard. It could best be said that rounding is random; operations in and near US round with differing standards and it is infeasible to specify a uniform rounding mode at this stage of design. Most ALU operations are accurate to within one bit on each input; transcendental functions have larger tolerances.

The lack of separable multiply and add instructions has consequences on rounding and sign preservation; when using MAD to perform only a multiply or addition, keep in mind that the other operation may influence the result despite apparent identities. For example, the obvious instructions to use for moving a value from one register to another both utilize MAD, either with the additive identity " $0 * 0 + r1$ ", or a combination of additive and multiplicative identities, " $r0 * 1 + 0$ ". Neither these instructions will correctly copy -0.0, because the adder cannot generate -0.0 except with two negative inputs. In this case, a more accurate move instruction would be " $-0 * 0 + r1$ ". (the ideal MOV instruction is described below).

US only supports comparisons against zero (predication, ALU result, and CMP) and +0.5 (CND), and this has consequences for implementing a general compare function with special values. It is tempting to implement a general comparison between values A and B by subtracting the results, but this will not have the desired effect for special values. In IEEE, an infinite value is equivalent to itself, but NaN is never equivalent to NaN. Yet (infinity - infinity) = (NaN - NaN) = NaN, and the results are indistinguishable. The limited operator set further complicates issues, since $(A > B)$ is not equivalent to $!(A \leq B)$ when either input is NaN.

The behaviour for CMP and CND is described below. When using the predicate comparison operators, the following hold for special values:

VALUE	X<0	X>=0	X==0	X!=0
+0.0	0	1	1	0
-0.0	0	1	1	0
+Inf	0	1	0	1
-Inf	1	0	0	1
NaN	0	0	0	1

* Denormals compare as equivalent to zero. Note that the only way a denormal may be involved in a comparison for predicate/alu result is if the output modifier is disabled with US_OMOD_DISABLED.

7.7.2 ALU Non-Transcendental Floating Point

Non-transcendental ALU operations maintain extra precision to represent computations where an intermediate result exceeds IEEE's finite range. For example, if a MAD generates a result outside the finite range, but the output modifier brings the value back into range, the ALU will generate a finite value, not infinity.

The ALU accepts denormal values, but denormals are flushed to zero, preserving sign. It is possible for a multiplicative output modifier to bring a denormal intermediate result into the normal range; in this case, the ALU will generate a normal nonzero value.

The ALU MAD operation, which many ALU operations are based on, follows standard IEEE rules when handling special input values, for example:

OPERATION	RESULT	NOTE
$x * \text{NaN}$	NaN	X is any value
$0.0 * \text{Inf}$	NaN	
$\text{Inf} * \text{Inf}$	Inf	
$\text{Inf} * -\text{Inf}$	-Inf	
$0.0 * -0.0$	-0.0	
$x + \text{NaN}$	NaN	X is any value
$\text{Inf} + -\text{Inf}$	NaN	
$\text{Inf} + \text{Inf}$	Inf	
$\text{Inf} + -1.0$	Inf	
$0.0 + -0.0$	0.0	
$-0.0 + -0.0$	-0.0	

Dot products may lose precision in cases where the values to be added differ greatly in magnitude. For example, if the two largest values to be added cancel exactly, and the next-largest value has a magnitude smaller by a factor of

2^{25} or more, US will emit +0.0 rather than the sum of the two remaining components. IEEE is silent on the behavior of such fused operations, and it seems unlikely that this condition will manifest very often.

MIN and MAX operations return the second argument if either input is NaN (this is consistent with IEEE and SM3 specifications); infinite values compare as usual. If both inputs are ± 0.0 , MIN and MAX will return the second input (consistent with IEEE and the SM3 spec) – as a result, $\text{MIN}(+0, -0) == -0$, and $\text{MIN}(-0, +0) == +0$.

CND and CMP operations return the second argument if either input is NaN; infinite values compare as usual. As with the predicate compare operators, +0.0 and -0.0 are both "equal" to 0.

MIN, MAX, CND, and CMP are guaranteed to return one of their first two arguments. If you use US_OMOD_DISABLED as well, then you will get a bit-exact representation of one of the first two arguments.

ALU operations usually enable the output modifier, which in turn standardizes NaN values and flushes denormal results to zero. A MOV instruction which preserves the source bits may be implemented by setting US_OMOD_DISABLED for the instruction and using the MAX(src, src) instruction. The output modifier cannot be disabled for a saturated MOV (MOV with clamping enabled).

7.7.3 ALU Transcendental Floating Point

In US, transcendental operations are EX2, LN2, RCP, RSQ, SIN, and COS (mathematically speaking, one of these functions does not belong). Transcendentals do not maintain extra internal precision; as a result, if the result of the transcendental operation exceeds the IEEE finite range, the ALU will generate infinity even if the output modifier would bring the result back into range. Similarly if the result is denormal, the ALU will generate a pure zero (preserving sign) even if the output modifier would bring the result back into the normal range.

Special values are computed as shown in the following table:

INPUT	EX2	LN2	RCP	RSQ	SIN	COS
+0.0	+1.0	-Inf	+Inf	+Inf	+0.0	+1.0
-0.0	+1.0	-Inf	-Inf	+Inf *	-0.0	+1.0
+Inf	+Inf	+Inf	+0.0	+0.0	NaN	NaN
-Inf	+0.0	NaN	-0.0	NaN	NaN	NaN
NaN	NaN	NaN	NaN	NaN	NaN	NaN

* For RSQ, recall that the square root occurs first. IEEE specifies $\text{sqrt}(-0.0) \rightarrow -0.0$; the US deviates from this, however this does not affect SM3 compliance since RSQ is always used with the absolute value input modifier for SM3 shaders.

7.7.4 Texture Floating Point

Projected and cubemapped texture coordinates are processed in the US block before being sent to the texture unit. The texture unit does not accept NaN, so NaN coordinates are converted to +infinity before being sent to the texture unit. As with the ALU, denormal inputs and denormal results are converted to pure zero, preserving sign.

The multiplier used for projection and cubemapping does not follow IEEE rules when handling special values. This will become apparent only when you attempt to project or cubemap a coordinate that contains an infinite or NaN component.

You should use caution when generating very large values for use as coordinates in a texture lookup. These values may generate infinite values when scaled by the texture dimensions, projected, or cubemapped.

7.7.5 *Legacy multiply behaviour*

By default multiplication by zero is IEEE-compliant for any ALU instruction. To support legacy (SM1.x) shaders which did not have an IEEE-compliant multiplier, set

US_CONFIG.ZERO_TIMES_ANYTHING_EQUALS_ZERO. Setting this bit will cause the multiplier used by MAD, dot products, MDH and MDV to treat "+-0 * x == +0" for all values x. Note that IEEE deviates from this behaviour when x is infinity or NaN. Modern shaders should not set this bit.

7.8 Writing to US Registers

The US configuration, integer constant, and boolean constant registers can be written to directly. However due to addressing limitations elsewhere in the pipe, the US instruction and ALU constant registers cannot be written directly; they must be programmed via a vector mechanism provided in the GA block. You write to the vector in two parts; first, you program the write destination in GA_US_VECTOR_INDEX, then you write data to GA_US_VECTOR_DATA until you have set all the values of interest.

7.8.1 *Writing instructions*

To write one or more shader instructions, set GA_US_VECTOR_INDEX.TYPE to GA_US_VECTOR_INST and GA_US_VECTOR_INDEX.INDEX to the address of the first shader instruction you want to write (from 0 to 511). Then write each instruction register to GA_US_VECTOR_DATA (usually, a total of 6 writes per instruction), in the following order:

	ALU/OUTPUT	TEX	FC
0:	US_CMN_INST	US_CMN_INST	US_CMN_INST
1:	US_ALU_RGB_ADDR	US_TEX_INST	0
2:	US_ALU_ALPHA_ADDR	US_TEX_ADDR	US_FC_INST
3:	US_ALU_RGB_INST	US_TEX_ADDR_DXDY	US_FC_ADDR
4:	US_ALU_ALPHA_INST	0	0
5:	US_ALU_RGBA_INST	0	0

A few notes:

- If you are writing an FC or TEX instruction, you may need to pad the vector with zeros; note that a zero dword must be written in the middle of the FC instruction.
- You can write to multiple instructions without updating the index. After you write 6 values to GA_US_VECTOR_DATA, the GA will automatically increment the instruction index. The index wraps at 512.
- If the last instruction you write to is a TEX or FC instruction, you do not need to write the last two zero dwords that are used for padding.
- Similarly, if you do not need to update all instruction registers for the last instruction you write, you do not need to write the registers that follow it.
- You should always write to GA_US_VECTOR_INDEX before writing a sequence of instructions, to ensure the GA is setup appropriately.

7.8.2 Writing ALU constants

To write one or more ALU constants, set `GA_US_VECTOR_INDEX.TYPE` to `GA_US_VECTOR_CONST` and `GA_US_VECTOR_INDEX.INDEX` to the address of the first constant you want to write (from 0 to 255). Then write each constant register to `GA_US_VECTOR_DATA` (usually, a total of 4 writes per constant), in the following order:

0:	<code>US_ALU_CONST_R</code>
1:	<code>US_ALU_CONST_G</code>
2:	<code>US_ALU_CONST_B</code>
3:	<code>US_ALU_CONST_A</code>

A few notes:

- You can write to multiple constants without updating the index. After you write 4 values to `GA_US_VECTOR_DATA`, the GA will automatically increment the constant index.
- If you do not need to update all components of the last constant you write, you do not need to write the components that follow it.
- You should always write to `GA_US_VECTOR_INDEX` before writing a sequence of constants, to ensure the GA is setup appropriately.

8. HiZ

8.1 Introduction

The R5xx HiZ (Hierarchical Z) unit performs a coarse z occlusion test on a tile of pixels to generate a mask indicating whether a set of quads within the tile is potentially visible. The Scan Converter (SC) block uses this mask to determine which quads will be passed on to the Rasterizer (RS) and which will be pruned. In this manner, HiZ provides an early-out mechanism for dropping quads.

This section presents an overview of the operation of the HiZ unit and a guide on how to program it.

8.2 Enabling HiZ

HiZ operation must be enabled in both the SC and ZB. It is enabled or disabled in the SC by setting the HZ_EN field in the SC_HYPERZ_EN field to 1 or 0. Similarly, it is enabled or disabled in the ZB by setting the HIZ_ENABLE field in the ZB_BW_CNTL register to 1 or 0.

8.3 Configuring HiZ

The following registers must be set to configure the HiZ unit for operation.

The ZB_HIZ_PITCH register specifies the pitch of the HiZ buffer in HiZ RAM. The host writes the pitch in pixels. The register interprets bits [13:4] as the 16 pixel-aligned HIZ_PITCH field. This field is used as pitch_mux in formula 1 in section 2.2, which calculates the DWORD address in HiZ RAM where z floor updates are written during z cache line evictions.

The ZB_HIZ_OFFSET register specifies a base offset into HiZ RAM. Bits [16:2] of this register are the DWORD-aligned HIZ_OFFSET field.

The HZ_MAX field in the SC_HYPERZ_EN register specifies whether the minimum or maximum z in the 8x8 tile is interpreted as the closest z whose floor is sent to the HiZ unit. The definition of which is the closest depends on the sense of the z function. For instance, if the z function is LESS, the minimum value is the closest. The programmer should set this field according to the z comparison function that is set in the ZFUNC field of the ZB_ZSTENCILCNTL register. Setting SC_HYPERZ_EN.HZ_MAX to 0 sends the floor of the minimum, and setting it to 1 sends the floor of the maximum.

The HIZ_MIN field of the ZB_BW_CNTL register specifies whether the HiZ unit updates the HiZ RAM with the floor of the minimum or maximum z value during z cache line evictions. As with the SC_HYPERZ_EN.HZ_MAX field, this field is also dependant on the z function set in the ZB_ZSTENCILCNTL. Setting HIZ_MIN to 0 updates HiZ RAM with the floor of the maximum z, and 1 updates with the floor of the minimum.

The following table shows how the SC_HYPERZ_EN.HZ_MAX and ZB_BW_CNTL.HIZ_MIN fields should be set according to ZFUNC. It also shows what the HiZ RAM should be initially cleared to, and what action the HiZ

comparison takes. The 'Z_MINMAX' column corresponds to the SC_HYPERZ_EN.HZ_MAX setting, and the 'ZB write to HiZ(X, Y)' corresponds to the ZB_BW_CNTL.HIZ_MIN setting.

ZFUNC	HiZ Clear Value	Z_MINMAX	HZ 2 nd Level Z Function	ZB write to HiZ(X,Y)
0 - Never	Don't Care	Min(Z0, Z1, Z2)	Prune the Block	Don't care
1 - Less	Floor(Z_Clear)	Min(Z0, Z1, Z2)	If (floor(Z_MINMAX) > HiZ(X,Y)) Prune the Block Else Pass the Block	Floor(Maximum(Z))
2 - Less or Equal	Floor(Z_Clear)	Min(Z0, Z1, Z2)	If (floor(Z_MINMAX) > HiZ(X,Y)) Prune the Block Else Pass the Block	Floor(Maximum(Z))
3 - Equal	Don't Care	Min(Z0, Z1, Z2)	Pass the Block	Don't care
4 - Greater or Equal	Floor(Z_Clear)	Max(Z0, Z1, Z2)	If (floor(Z_MINMAX) < HiZ(X,Y)) Prune the Block Else Pass the Block	Floor(Minimum(Z))
5 - Greater Than	Floor(Z_Clear)	Max(Z0, Z1, Z2)	If (floor(Z_MINMAX) < HiZ(X,Y)) Prune the Block Else Pass the Block	Floor(Minimum(Z))

6 - Not Equal	Don't Care	Max(Z0, Z1, Z2)	Pass the Block	Don't Care
7 - Always	Don't Care	Max(Z0, Z1, Z2)	Pass the Block	Don't Care

8.4 HiZ Clear with PM4 Packet

The most efficient manner for a driver to clear HiZ RAM is to use the 3D_CLEAR_HIZ Type-3 PM4 packet. The 3D_CLEAR_HIZ packet is described below.

3D_CLEAR_HIZ

Functionality

Clear HIZ RAM.

Format

Ordinal	Field Name	Description
1	[HEADER]	Header of the packet
2	START	Start
3	COUNT[13:0]	Count[13:0] – Maximum is 0x3FFF.
4	CLEAR_VALUE	The value to write into the HIZ RAM.

8.5 Example: Putting it All Together

Here is a simple example that demonstrates typical steps in setting up the HiZ unit:

```
// enable z buffering
regwrite (ZB_CNTL, Z_ENABLE, 1);
// set the ZFUNC to LESS
regwrite (ZB_ZSTENCILCNTL, ZFUNC, 1); // 1 = LESS
// enable HiZ in the SC
regwrite (SC_HYPERZ_EN, HZ_EN, 1);
// enable HiZ in the ZB
regwrite (ZB_BW_CNTL, HZ_EN, 1);
// set HZ_MAX in SC_HYPERZ_EN to MIN for ZFUNC=LESS
regwrite (SC_HYPERZ_EN, HZ_MAX, 0);
// set HIZ_MIN in ZB_BW_CNTL to MAX for ZFUNC=LESS
regwrite (ZB_BW_CNTL, HZ_MIN, 0);
// set HIZ_OFFSET to 0
regwrite (ZB_HIZ_OFFSET, HIZ_OFFSET, 0);
// set HIZ_PITCH to 1024
regwrite (ZB_HIZ_PITCH, HIZ_PITCH, 1024 >> 4);
// initialize the HiZ RAM to a clear value of 0xff
// for all the bytes in a 1024x768 area:
// set initial write index. It will auto-increment
// after each write to ZB_HIZ_DWORD
regwrite (ZB_HIZ_WINDEX, HIZ_WINDEX, 0);
```

```
// write floors for one 8x8 tile with each DWORD.
// this example assumes a dual-pipeline configuration.
// since half the screen is owned by the second pipeline,
// and host writes are broadcast to both pipeline RAMS
// at the same address, we write the clear DWORD for
// half of 1024>>3. In a single-pipeline configuration,
// we would write the clear DWORD for 1024>>3.
for (int y = 0; y < (768 >> 3); y++)
{
    for (int x = 0; x < ((1024 >> 3)>1); x++)
    {
        regwrite (ZB_HIZ_DWORD, HIZ_DATA, 0xffffffffL);
    }
}
// read back a DWORD in pipeline 1 at address 0
regwrite (SU_REG_DEST, SELECT, 1);
regwrite (ZB_HIZ_RINDEX, 0);
DWORD dwGetHiZValue = regread (ZB_HIZ_DWORD);
```

8.6 State Changes That Invalidate HiZ

This section describes the conditions that invalidate HiZ RAM and those that have no effect.

Disabling Z testing or disabling Z writes does not invalidate HiZ RAM, so no special action is required in these cases. Because both of these states result in no new z data being written to the z buffer, there are no z cache evictions that update the contents of HiZ RAM. Therefore, HiZ RAM is preserved and can continue to be used after Z buffering or Z writes are re-enabled.

Certain ZFUNC transitions can invalidate the contents of HiZ RAM. As a general rule, the safest approach when ZFUNC is changed is to disable HiZ testing until the contents of HiZ RAM are reset, e.g. until the start of the next frame where HiZ RAM is re-initialised. Having said that, there are transitions where either HiZ does not need to be disabled, or it may be re-enabled before the end of the frame:

- 1) HiZ does not need to be turned off when transitioning back and forth between LESS and LESSEQUAL. HiZ must be disabled when transitioning from either LESS or LESSEQUAL to EQUAL, but may be re-enabled when transitioning back from EQUAL to LESS or LESSEQUAL.
- 2) HiZ does not need to be turned off when transitioning back and forth between GREATER and GREATEREQUAL. HiZ must be disabled when transitioning from either GREATER or GREATEREQUAL to EQUAL, but may be re-enabled when transitioning back from EQUAL to GREATER or GREATEREQUAL.

All other transitions invalidate the contents of HiZ RAM with respect to the new sense of the z comparison.

9. Driver notes

9.1 R5xx Changes

9.1.1 PS3.0

R520 TX supports pixel shader model 3.0. Support for 32-bit IEEE input coordinates from the shader and 32-bit IEEE output colors to the shader. Support for per pixel (or per quad) TEXLDB, TEXLDL, and TEXLDD instructions.

9.1.2 Filter4

R520 can support limited Filter4 filtering. The kernel is 4x4 symmetric and separable with 16 phases. The kernel weight precision is S,1.9. There is one global kernel shared by all textures. The kernel is loaded using the global TX_FILTER4 register. Filter4 can be enabled per texture using the MAG and MIN filter registers. Only one of four 8-bit components can have Filter4 applied at a time. That component is selected using FORMAT2.SEL_FILTER4.

9.1.3 Maximum Image Extents

R520 supports up to 4K texels in width, height, or depth.

9.1.4 Trilinear Interpolation Precision

R520 supports 6-bits of trilinear precision. R420 supported 5-bits.

9.1.5 Image Formats

New image formats over R420 : ATI1N, 10, 10_10, 10_10_10_10, 1, 1_REVERSED

9.1.6 Border Color

Added border color support for FAT formats, specifically 16_16_16_16, 16f_16f_16f_16f, 32f_32f, 32f_32f_32f_32f. Border color is now supported for all image formats.

9.1.7 Non-Square mipmaps with border color

Added mode register FILTER1.BORDER_FIX which when asserted will stop right shifting the texture coordinate once the image size has been right shifted to one. BORDER_FIX only needs to be asserted when the clamp mode is a border mode and mipmapping is enabled and the mipmap is non-square. However it should be safe to assert BORDER_FIX anytime.

9.1.8 POW2FIX2FLT

Added mode register FORMAT2.POW2FIX2FLT which when asserted the TX will divide by pow2 instead of pow2-1 when doing fix2float conversion of the filtered texture color.

9.1.9 GA_IDLE

R520 has a new status register called GA_IDLE which can be used to get information about back-end hangs. To read this register, the following procedure may be used:

- Read RBBM_STATUS to make sure the HW is hung. If GA bit is busy, this may indicate a back-end hang.
- Write 0x32005 to the RBBM_SOFTRESET register. This is to reset GA, CP and VAP.

- Read RBBM_SOFTRESET to make sure the write went through.
- Write 0 to RBBM_SOFTRESET. This is necessary to get VAP to go idle.
- RBBM_STATUS should now show that VAP and CP are idle but GA still busy. If GA is not busy, then GA_IDLE should be readable at this point.
- If GA was still hung, write 0x200 to GA_SOFTRESET
- Now GA_IDLE can be read. See the register spec for details on what each bit means. Note that a “1” indicates an idle unit.

9.1.10 HDP surface0 upper bound 64 byte alignment requirement

HDP surface 0 upper bound needs at least 64 byte alignment. This applies only to surface 0 and not to surface 1 to 7, which can be programmed as specified (32 byte aligned).

9.1.11 New Soft resets for CP

CP now has total of 3 soft resets:

CP_SOFT_RESET => as before (for backward compatibility).

CP_SOFT_RESET_NO_DMA => soft reset CP except DMA engine.

CP_SOFT_RESET_DMA => soft reset only DMA engine of CP.

9.1.12 CP STOP CONTEXT

Once SC/CB informs CP to stop_context, CP will not fetch/process any further read requests from command buffers.

9.1.13 Updated CP Scratch compare logic

Scratch register interrupt functions as follows:

(a) Driver programs two 32bit registers with timestamp for comparisons with a pair of scratch registers. We can call this as DRV_REGS

(b) Driver programs PM4 stream with writes to two consecutive scratch registers (paired as 0-1,2-3,4-5,6-7) to be compared with DRV_REGS.

(c) In due course of time PM4 pkt would get executed , this address/data would sit in the input fifo of CP , ready to program both the scratch registers.

(d) As soon as CB (color buffer) sends two sets of RESYNC pulses (4 of them from each pipe with mask), CP allows the FIFO contents to get transferred to scratch registers for further action. (RBBM transactions are stalled at this time)

(e) SCR_REGS data gets compared with DRV_REGS data for preprogrammed condition of either "equality" or "non-equality" or "greater than" or "less than " or "greater than or equal" or "less than or equal".

(f) If the condition is satisfied then an interrupt is generated informing driver/system to wake-up and proceed for the next command.

(g) The scratch register data gets written to system memory (if umask is set) at premapped address to be read back by the system/driver.

9.1.14 Host requests (GFX, ISYNC_CNTL, RBBM_GUICNTL, WAIT_UNTIL)

Pre-R5xx, requests made within the aperture range 0x1400 - 0x1EFF and 0x2000 – 0xFFFF were queued. From R5xx, onwards these requests will not be queued. ISYNC_CNTL, RBBM_GUICNTL and WAIT_UNTIL can be programmed only for queued requests. As none of the host (PIO) requests are queued, host cannot program above three registers through PIO.

9.1.15 Double Z

RV530 has two Z pipes, but a single raster pipe. In the past, SU_REGDEST was used to select which raster pipe you want to select. On RV530, you use FG_ZBREG_DEST. Because the pipe selection happens in the FG, you **must be in Z bottom mode**. This mainly applies to occlusion queries where you want to get Z pass data from each Z unit.

9.1.16 FP16 AA support

R5xx-family chips support FP16 AA. However, there is an issue with the blend optimizations while FP16 AA is enabled. Because of this, RB3D_BLEND_CNTL.DISCARD_SRC_PIXELS **must be** set to CB_DISCARD_SRC_DISABLE while FP 16 AA is enabled.

9.1.17 FP16 Blending

FP16 (64bit pixel) blending is added in R5xx parts. FP16 Blend bandwidth is half the rate of 32 bit pixels; i.e. 8 pixels/clock in a 16 pipe system. FP16 blending uses the new 64 bit clear color register and constant color registers. Setting the FP16 blend equation to multiply by 1.0 is subtly different from disabling blending. A negative zero (0x8000) will be converted to zero (0x0000) if it is blended but 0x8000 will be drawn if blending is disabled. The driver should distinguish between FP16 and 16 bit integer formats and never enable blending for 16 bit integer formats. The CB FP16 implementation supports denorms but does not support NaNs and Infs. Only a 4 component (ARGB16161616) format is supported. There are no I16 or IA1616 formats.

9.2 Interface Notes

9.2.1 Raster Reset

The proper sequence for a full raster reset is the following:

- Perform a RBBM reset with the GA RBBM client flag set
- Perform a register write to the GA_SOFT_RESET register, with a value of 0x200 or higher

In the above sequence, the first item causes the GA to delete all pending register reads & writes and resets the RBBM interface. If the GA status is idle, then the RBBM reset is not required. After this reset, the GA is ready to accept register read and write commands. However, the 3D pipe could be in a hung state, which would prevent it

from accepting 3D commands or register commands.

The second operations (GA_SOFT_RESET) causes a soft reset of the 3D pipe. This reset causes a loss of all state in the 3D, except in the GA & SU blocks. Shadow register values are **not** reset. The 3D pipe should then switch to the idle state after the reset. It will take 0x200+ cycles for the idle state to be re-asserted (should be less than 0x200 + 64). The value of 0x200 is a suggestion, which should be enough to reset all the pipelines. A larger value can be used (up to 16b), but should not offer any benefit.

9.2.2 Non-textured, non-colored primitives

The R300 always does at least one 2D texture and one color per primitive. The RS_COUNT has a baseline value of 1, which indicates up to 1 color and 1 texture are to be rasterized. The other registers used to specify the colors and textures are the VAP_RASTER_VTX_FMT_0 and RASTER_VTX_FMT_1 registers. These registers can be set to have no color and no texture. So if one wants to specify a non-textured and non-color primitive, one should set the RASTER_VTX_FMT registers to no color and no texture, and set the RS_COUNT to 0. The raster will still rasterize the extra colors and textures, but the rasterized values will be wrong. The shader code should then be set to ignore the texture coordinates and colors and to setup a constant color, or the CB could be disabled so no color writes occur (to setup the ZB, for example).

9.2.3 Flushing primitives out of the SC

All 3D operations need to be terminated with a register write to the SC, US or some down stream register. Unless this is done, the SC/RS will never assert idle (which will be reflected as GA_BUSY). The final polygon rendered should still drain out of the pipe.

9.3 Register Notes

9.3.1 Update to register reads

R520 and follow-on chips now support simultaneous G3D register reads and writes. Coherency of reads and writes is not guaranteed (reads can occur before writes). However, switching from write/cmd mode to read mode (PIO through RBBM) does not require idling the G3D pipe anymore. However, this mode is not enabled by default. The following fields have been added to the GA_ENHANCE register:

REG_READWRITE 2:2
REG_NOSTALL 3:3

When the REG_READWRITE field is set, this enables the GA to support simultaneous register reads and writes. However, simply enabling this mode allows the GA to receive both read and write commands (and to deal with both), but it still tells the GA to wait for register return before continuing. Consequently, the GA will cause a stall bubble, of (n) cycles to be injected, where (n) is the latency for register read back. If the register is shadowed, that value is very small (A few cycles). If not, then it can be hundreds of cycles

When REG_NOSTALL field is set, this enables GA to support mixing the G3D pipe with reads and other activity; in this mode, the register read is simply part of the pipeline data. This mode would allow for no performance hit at all, when doing register reads, since the GA will not cause a stall bubble (it will not wait for the register data to return). It does not permit the GA to have multiple outstanding read requests, but it allows for minimal performance impact.

9.3.2 Registers that cause stalls

9.3.2.1 ZB Registers

Unpipelined registers

Writes to these registers causes a stall in the pipe. The stall is on as long as there are any quads in the ZB block. Once the ZB block is empty the register is updated and the stall is removed. If multiple unpipelined registers are updated with no quads in the middle, then the first one will cause a stall to drain the ZB, but the following unpipelined writes will go at full speed...

ZB_FORMAT
ZB_ZCACHE_CTLSTAT
ZB_BW_CNTL
ZB_DEPTHOFFSET
ZB_DEPTHPITCH
ZB_DEPTHCLEARVALUE
ZB_HIZ_OFFSET
ZB_ZPASS_DATA
ZB_ZPASS_ADDR
ZB_DEPTHXY_OFFSET

Pipelined Registers

ZB_CNTL
ZB_ZSTENCILCNTL
ZB_STENCILREFMASK
ZB_HIZ_DWORD

Special register ZTOP

Whenever ZTOP register is switched from 1 to 0 or 0 to 1 a stall occurs at the SC stage of the pipe and it goes away when all the quads between the SC and CB are drained from the pipe. Then the Zbuffer is moved in the pipe-lined. Writing to Ztop a value that it currently holds (0 to 0 or 1 to 1) has no performance penalty.

9.3.2.2 CB Registers

Unpipelined registers

Writes to unpipelined registers cause the CB to stall until all previous quads, pipelined registers, and partially pipelined registers have finished processing. Once an unpipelined register has been written, a write to another unpipelined register will not cause more stalls as long as there are no intervening quads, pipelined registers, or partially pipelined registers. The unpipelined CB registers are the following:

RB3D_CCTL
RB3D_COLOR_CLEAR_VALUE
RB3D_COLOROFFSET(0, 1, 2, 3)
RB3D_COLORPITCH(0, 1, 2, 3)
RB3D_DSTCACHE_CTLSTAT
RB3D_AARESOLVE_OFFSET
RB3D_AARESOLVE_PITCH
RB3D_AARESOLVE_CTL
GB_TILE_CONFIG
GB_AA_CONFIG

Partially pipelined registers

Partially pipelined registers are pipelined everywhere in the CB except in one module. That module must stall until all the quads that it is currently processing have finished. The number of stall cycles should not exceed about 15 cycles. The partially pipelined CB registers are the following:

RB3D_ROPCNTL
RB3D_CLRCMP_FLIPE
RB3D_CLRCMP_CLR
RB3D_CLRCMP_MSK

Pipelined registers

These registers are fully pipelined and may be freely intermixed with quads without causing stalls. The pipelined registers are the following:

RB3D_BLENCNTL
RB3D_ABLENCNTL
RB3D_COLOR_CHANNEL_MASK
RB3D_CONSTANT_COLOR
RB3D_DITHER_CTL

CB register ordering

Because unpipelined registers can stall on preceding pipelined or partially pipelined registers, it is recommended that all unpipelined registers are written first. Pipelined and partially pipelined registers may be freely intermixed without penalty.

9.3.2.3 TX Registers

Global registers

Global registers are registers that affect all texture stages. On a write to any global texture register, the US will wait for the TX to flush completely before passing the register to the TX. This could take on the order of a couple hundred clocks worst case. Obviously writes to these registers should be minimized. There are two global registers that cause the TX to flush : TX_INVALIDTAGS and TX_PERF.

Stage registers

Stage registers are registers that only affect 1 of the 16 possible texture stages. On a write to a Stage register, the US will wait until that texture stage is inactive in the TX pipe, and only then will it pass the register to the TX. It is therefore important to rotate through the 16 sets of registers to avoid a register write to a stage that is still being processed in the TX. Otherwise unnecessary stalls will occur.

9.3.3 Registers that affect performance

9.3.3.1 US_W_FMT

When the W value is not being used (FG_DEPTH_SRC does not select discrete W), then this register should be set to specify that the source is the US and the format is always 0. Specifying that W comes from the rasterizer causes stalls inside the US.

9.3.4 Other Registers

9.3.4.1 GB_TILE_CONFIG

The GB_TILE_CONFIG contains multiple raster pipe control fields. Some of these need a soft reset afterwards to apply the change. All of them require the pipe to be idle before performing the change. As well, in the R5xx, this register is simply shadowed in the shadow RAM, except for the PIPE_COUNT field, which always indicates the internal value of this field. This might or might not match the written value, depending on bad_pipes and max_pipes. All fields after Hard reset will show the default values shown below. The fields all hard reset to the default values.

Soft reset (GA_SOFT_RESET) does not affect this register.

Here are the fields, with the default values, the reset status and a slight comment:

Fields	Possible values	Defaults	Reset	Comments
Enable [0:0]	0: Disable tiling 1: Enable tiling	Enabled (1)	If changed, soft reset should be applied	The default value of (1) should never be changed
Pipe_count [3:1]	0: RV350 3: R300 6: R420 (3 pipes) 7: R420 (4 pipes)	Depends on fuses	If changed, soft reset should be applied	Should be programmed with 4P (7), 3P (6), 2P (3) or 1P (0).
Tile_size [5:4]	0: 8x8 pixels 1: 16x16 pixels 2: 32x32 pixels	1 : 16x16	No reset required	R5xx supports 16x16 or 32x32 only. 32x32 should be used, in 3p or 4p cases, as performance testing determines
Super_size [8:6]	0: 1x1 tile 1: two 1x1 A,B tiles 2: one 2x2 tile 3: two 2x2 A,B tiles	0: 1x1 tile		Only 1x1 mode guaranteed – Feature only used in multi-chip boards Only support super tiling with 1, 2 or 4 pipes (not in 3P config)
Super_X, Super_Y, Super_Tile [15:9]	7b ID identifies unique location of chip in multi-chip board	0	No reset required	When in single chip, value should be 0.
Subpixel [16:16]	0: 1/12 subpixel 1: 1/16 subpixel	0: 1/12	Can be changed whenever pipe is idle without Reset	Selects the 1/12 or 1/16 subpixel mode
Quads_per_ras [18:17]	0: 4 quads 1: 8 quads 2: 16 quads 3: 32 quads	0: 4 quads	No reset required	Reserved for R350 – Leave at 0 for R300, RV350
Bb_scan [19:19]	0: Use intercept scan conv. 1: Use bounding box scan conv.	0: Intercept	No reset required	Intercept method is new and higher performance. Bounding box is traditional & slower, but “guaranteed” to work. Should only be changed if raster issues come up.
Alt_scan_en[20:20]	0: Do Z type scan conversion 1: Do S type scan conversion	0: Z type	Can be changed when pipe idle.	RV350 and R420 support S scan conversion, which maintains local coherence from scan line to scan line, instead of Z type

				which “goes back” to the left on every scan line
Alt_offset[21:21]	0: Use 1440/1088 offset for SC 1: Use 672/1088 offset for SC	0: 1440/1088 mode	Should be switched when pipe is idle.	When in mode (1), allows for a render target of 4k x 4k, only for 1/12 subpixel mode. The X,Y offsets in the GA are not affected, so that the viewport should be loaded with a value of (672-1440=-768) to match.
Subprecision [22:22]	0: Uses 4b of sub pixel precision 1: Uses 8b of sub pixel precision	0: 4b	Should be changed when pipe is idle.	Allows for 4 extra bits of subpixel precision. All computations done in higher precision when in use. Should always be enabled.
Alt_tiling [23:23]	0: Use regular tiling for 3P mode 1: Use alternate tiling for 3P mode	0: Regular tiling	No reset required	Empirical testing needs to be done to determine which has higher performance. Either tiling mode is possible.
Z_extended[24:24]	0: Use [0,1] Z clamp range 1: Use [-2,2] Z range	0: R3xx/R4xx mode	Should be changed when pipe is idle	Should allow us to increase guardband. Per pixel clamping to [0,1] still occurs in SC

9.3.4.2 GB_PIPE_SELECT

GB_PIPE_SELECT controls the physical and logical pipe mapping, as well as the total number of active pipes. It works with GB_TILE_CONFIG to configure the pipelines. It is procedural and not shadowed; if you read the register back after hard reset, you should get the default values. Changing this register is generally not required, if the fuses are set correctly (i.e. max_pipes reflects total number of working and desired pipes; bad_pipes indicates which of the 4 pipes are bad). The MAX_PIPES and BAD_PIPES fields are read-only, and reflect what the SU unit receives from the fuse unit. The fuse unit can be programmed to alter the max_pipes/bad_pipes, but not contrary to the actual fuse settings (can never set, through SW, internally max_pipes to higher than the fuse setting).

Fields	Possible Values	Defaults	Reset	Comments
PIPE0_ID [1:0]	0, 1, 2, 3	Depends on fuses – Often 0	Pipe should be soft reset after changing	Determines the logical mapping of physical pipe 0
PIPE1_ID [3:2]	0, 1, 2, 3	Depends on fuses – Often 1	Pipe should be soft reset after changing	Determines the logical mapping of physical pipe 0
PIPE2_ID [5:4]	0, 1, 2, 3	Depends on fuses – Often 2	Pipe should be soft reset after	Determines the logical mapping of physical pipe 0

			changing	
PIPE3_ID [7:6]	0, 1, 2, 3	Depends on fuses – Often 3	Pipe should be soft reset after changing	Determines the logical mapping of physical pipe 0
Pipe_mask [11:8]	0 through 16	Depends on fuses – Max is 4	Pipe should be soft reset after changing	Each bit of the mask identifies if a physical pipe is good (1) or not (0). A value of 0xf indicates 4 good pipes.
Max_pipes [13:12] Read Only	0: 1 good pipe 1: 2 good pipes 2: 3 good pipes 3: 4 sweet pipes	Depends on fuses	Read only field	Indicates the fuse state for the number of good pipes. GB_TILE_CONFIG.pipe_count should not try to use more than this number of pipes. HW will ignore any programming that tries to override this value.
Bad_pipes [17:14]	0 through 16	Depends on fuses	Read only field	Returns a (1) for each good pipe. Matches pipe_mask format. You cannot enable more pipes than max_pipes.
Config_pipes [18:18]	0: Do nothing 1: Force auto-config	N/A	Should be soft reset after writing, if fields are changed	Causes the HW to ignore the pipe#_ID and pipe_mask fields, and to generate those values based on the fuse state.

The GB_PIPE_SELECT configures the pipes to match the desired configuration. SW should not attempt to configure the pipes in a way that contradicts the max_pipes value, which is programmed through on-die fuses at die test time. SW will be ignored if it contradicts the fuses. However, the bad_pipes can be programmed to enable a “marked bad” pipe, but it must then disable a good pipe, since the total number of active pipes must be equal or less than max_pipes, otherwise the HW will ignore the bad_pipes register.

9.4 Feature Notes

9.4.1 Switching Pipeline configuration / Resetting 3D pipe

The raster pipeline can be switched from single pipe to dual pipe and back through the use of the GB_TILE_CONFIG register. As well, the GB_TILE_SELECT should be used to select the physical pipes to use. Switching from one mode to another requires the following sequence:

- The 3D pipe must be idle (WAIT For 3D IDLE)
- The GB_PIPE_SELECT register should then be read, to determine the current max_pipes and bad_pipes. The SW can then program it with those values or new values.
- The GB_TILE_CONFIG register’s PIPE_COUNT field should be written with the appropriate value (use PIO):
 - 0x0 for single pipe (RV350)
 - 0x3 for dual pipe (R300)
 - 0x6 for triple pipe (R420-3P)
 - 0x7 for quad pipe (R420)
- The 3D pipe & GUI must be idle again after writing the registers
- The GA_SOFT_RESET register must be written with 0x100 or greater (use PIO)

- Wait for ~1 ms (prevents race conditions between GA_SOFT_RESET And 3d idle status read)
- The 3D pipe & GUI must be idle again to permit any other activity (register or data) (read RBBM status for GA idle)
- If the fuses are set to limit the number of active pipes to a given level (1,2,3 or 4), then GB_TILE_CONFIG and GB_PIPE_SELECT settings will not be able to override those values. A hang or other problem could actually occur if SW tries to enable “bad pipes”.

The above sequence will invalidate the state of the pipe as well as switching it.

For resetting the pipe, the same process as above is followed:

- The 3D pipe must be idle (WAIT for 3D IDLE) or hung
- The RBBM soft reset of GA must be done, if chip is not idle
- The GA_SOFT_RESET register must be written with 0x100 or greater (use PIO)
- Wait for ~1ms
- The 3D pipe & GUI must be idle again to permit any other activity (read RBBM status for GA idle)

9.4.2 Switching vertex data rounding mode

The GA_ROUND_MODE register can be used to select between round to nearest and truncate (round to 0) for both vertex geometry (X,Y) and color conversions. The default is to truncate. This register should only be changed when the 3D pipe is idle. Otherwise, switching can occur in the middle of primitives, which could cause visual anomalies. This register, once set, should never be changed again.

9.4.3 Switching from 1/12th to 1/16th subpixel mode

Switching from 1/12 to 1/16 subpixel mode is done through the use of the GB_TILE_CONFIG register. Normally, changing this register requires the use of a soft reset afterwards. However, changing the subpixel field does not require a reset. However, it does require that the 3D pipe be idle. Also, the Z buffer can become incompatible after switching the subpixel mode. Basically, if Z compression is enabled, the values contained in the Z buffer are incompatible between subpixel modes, so that the buffer needs to be re-initialized after each switch.

9.4.4 Fastfill and compression in Z

Fast fill and compression only works in micro-tiled mode. The following table shows the valid combinations of fast fill and rd/wr compression :

Fast Fill	RdCompression	WrCompression	description
0	0	0	no fast-fill or compression, the Z buffer has to be cleared explicitly.
1	0	0	fastfill, Z buffer does not need to be cleared explicitly, The zmask should be set to 2'b00 for all for all 4x4 tiles on the drawing window. The zb_clearvalue will hold the cleared Z value
1	1	1	Same as above , with compression turned on.
1	1	0	Used to decompress , a compressed Z buffer ...

Note that all other combinations in the above table are invalid. The emulator is programmed to generate an assert in these cases. Compression does not work with all 16-bit formats. For 16-bit integer buffering, compression causes a hung with one or two samples and should not be used.

9.4.5 Z-Top

It is beneficial for performance to have Z buffer at the top of the pipe, since the quads that do not pass Z buffer do not have to be sent to the shader. Depending on how many instructions the shader executes, this could gain you a lot of advantage. There are several cases in which the Z buffer has to be at the bottom:

- 1- Alpha threshold (afunction) is turned on
- 2- Shader uses texkill instructions.
- 3- Chroma key cull enabled.
- 4- W-buffering

Cases 1,2 and 3 can kill a pixel before Z buffering . However, if the contents of the Z/stencil buffer will not be modified, then ztop can remain enabled (1). This implies that the following state is in effect:

- 1- Z-buffering is disabled or Zwrite-mask is off .
- 2- Stencil is disabled or stencil-wrmask is off or SFAIL/ZPASS/ZFAIL are all set to KEEP.

W values are always generated at the bottom of the pipe, so for w-buffering, ztop should be set to 0.

There is penalty in moving the Z buffer from top to bottom or vice versa. The pipe will be stalled at the sc and all the quads that are in the pipe between the sc and cb have to be processed before the switch occurs. This is all done in HW. If the ztop =0 and you write another 0 to it, there is no performance penalty. If it is 1 and you write a 1 to it, there is no performance penalty. The penalty is only incurred when you switch from top to bottom or bottom to top.

9.4.6 Sub-sample locations

In point sample mode, POS0 defines the X,Y of the upper left pixel of the quad. POS1 defines the X,Y of the upper right pixel of a quad. POS2 defines the X,Y of the lower left pixel in a quad and POS3 defines the X,Y of the lower right pixel in a quad. This is done so that in R200 style super-sampling mode, the sample locations for the pixels can be jittered. Hierarcical Z has to be shut off when the 4 pixels in the quad have different locations in point sample mode.

In multi-sample mode , samples 0,1,2,3,4,5 of pixels 0,1,2,3 of a quad are defines by pos0,1,2,3,4,5 .., so all pixels in the quad have the same sub-sample pattern.

There is a quirk when setting the MSPOS0.msbd0_x. The value represents the distance from the left edge of the pixel quad to the first sample in subpixels. All values less than eight should use the actual value, but '7' should be used for the distance '8'. The hardware will convert 7 into 8 internally.

It is also important that when using less than 6 multisample positions, the unused samples must be set to the position of other valid samples.

9.4.7 Dithered Clears

Fast cmask clears of a subsampled buffer will not be dithered.
The ZB doesn't do color dithering so ZBCB clears will not be dithered.

When doing clears in 16 bit mode with dithering enabled the driver should examine the clear color value and determine if it would be affected by dithering. For example a color value of zero when dithered will remain zero for all dither factors. If the color would not be affected by dithering either fast clears or ZBCB clears can be used, otherwise a full window rectangle write should be used to clear the buffer. This is only an issue for 16 bit buffers with some clear color values so hardware support is not provided.

9.4.8 4x AA tiling

R420 introduced a new tiling mode for 4x AA buffers. Each 4x4 block of pixels occupies 8 cache lines of memory (32 bytes per cache line). When the block is decompressed, the color samples are grouped together. Thus, all 16 sample 0s are in one chunk, all 16 sample 1s are in another, etc. On R300, decompressed blocks were organized with sample 0s being first, then sample 1s, then 2s then 3s. On R420, groups of 8 cache lines have the top and bottom halves interchanged when the block address is odd in the x dimension. For example, block (0,0) is organized just like R300, but block (1,0) would have samples 2 and 3 before samples 0 and 1. Block (2, 0) would be just like R300 again. **Note: This new tiling mode only applies when memory mapping is disabled.**

9.4.9 8x8 Z plane compression

Chips based on the RV350 and beyond support a new 8x8 Z plane compression mode specified in the GB_Z_PEQ_CONFIG register. When compression is not enabled, the Z plane compression mode has to be set to 4x4 in order for the GA and ZB to agree on the Z plane equation format and avoid visual corruption.

9.5 Blend optimization notes

9.5.1 Disabling reads during blending

The destination color is not necessary for some blending operations. The cb has a read enable called RB3D_BLEND_CNTL.READ_ENABLE to control whether the destination color is read or not during blending operations. Reads must be enabled during blending operations that require the destination color. Failure to do so will result in incorrect results. Leaving the register enabled when blending is disabled does not have any adverse affects.

9.5.2 Discarding pixels based upon the source color

There are cases where blend operations do not change the contents of the frame buffer. For example, adding zero to the frame buffer does not change the frame buffer contents. Although the operations do nothing to the frame buffer, they still take bandwidth. The cb can discard pixels based on the source color to eliminate some useless blend operations. The RB3D_BLEND_CNTL.DISCARD_SRC_PIXELS register controls the functionality. When to use this feature is under driver control. The cb will not override this register if it is not safe to use under the current blending mode.

9.5.3 ZB/CB cache flushes

ZB/CB cache flushes take hundreds of cycles to complete, so they should be avoided if possible. Performing a cache flush when the cache is already clean only takes a cycle, so there isn't any penalty for flushing a cache multiple times as long as there are no intervening quads.

9.6 Texture Notes

TX_CHROMA_KEY must be the same format as the texture being keyed with any unused msb's zero'd. And should be AVYU for all YUV formats.

TX_FMT_*_MPEG formats are implicitly signed. However the TX_FORMAT1_*_SIGNED_COMP* bits must still be explicitly set. It is a bug to use an MPEG format and indicate that the components are unsigned.

9.7 Errata

9.7.1 Facing bit with Polymode & colors

In R5xx, just as R4xx, when lines are sent from the setup to the rasterizer, the setup's facing information is lost, since no facing information is sent between the SU and SC. This implies that lines will always be treated as "forward facing" in the scan converter. This facing information is passed to the shader as the "facing bit", which can be used as a conditional.

Consequently, in polygon outline mode, where lines have front and back meaning, when rendering a line polygon (for either front or back), the facing bit will always be marked as front facing, regardless of the facing of the original triangle. Back / Front culling does occur correctly here (i.e. if the front render is line and front face culling is enabled, then no front facing lines will get drawn), but the facing bit for rendered lines or points will be always front facing.

The R5xx contain a work-around for this problem, in the form of a special mode. This mode is enabled by setting the bits of SU_PERF.PERF3_SEL to all 1's (31). When enabled, this will force the sign bits of the components of the colors to be set to (0) for front facing, or (1) for back facing. All colors in a primitive will get their sign bit changed, based on the facing of the primitive, or of its provoking vertex (in the case of polymode). If source colors are positive, then, in the pixel shader, back facing polygons will have negative colors, while front facing polygons will have positive colors. This mode will work, regardless of PS2 or PS3 mode in the pipe.

9.7.2 PS3 Polymode textures

In the R5xx mode, polymode texture coordinates are not computed correctly when the pipe is in PS3 mode. To fix this, a polymode_ps3 fix has been implemented. This mode is enabled by setting the GA_PERF.PERF3_SEL[4] bit to 0x1. This mode should only be set when in PS3 mode. As well, when set and in PS3 mode, colors will not longer be computed correctly in polymode for polygons, but that is acceptable, since colors are not naturally available in PS3 mode.

9.7.3 GA Fog stuffing

The GA supports stuffing the fog value (either an FP20 from C0a->C3a, or W or Z) into a texture component. The limitation for R5xx, is that the GA can only stuff the component of the first active texture. It can only stuff any one of the first 2 active components of the first active coordinate set.

9.7.4 Line rendering

When subpixel precision is enabled, there is a possibility that the rendering hardware will determine an incorrect dominating direction, when the start and end X values of the line have the same 1/12 or 1/16 pixel value, but different subpixel values. This can cause double pixel hits or missing pixels in continuous line drawing. The work-around, is to disable subpixel precision rendering when drawing lines.

9.7.5 PS3 VTX_FMT & PS3_TEX_SOURCE

Writes to the PS3_VTX_FMT and PS3_TEX_SOURCE register can cause bad textures or hangs in R5xx chips, if followed immediately by VF_CNTL writes (i.e. draw command). Following any of these 2 registers with 2 register writes (to GA or any block below) will always avoid the problem, before the next VF_CNTL.

10. Registers

10.1 Color Buffer Registers

CB:RB3D_AARESOLVE_CTL · [R/W] · 32 bits · Access: 8/16/32 · MMRReg:0x4e88			
DESCRIPTION: <i>Resolve Buffer Control. Unpipelined</i>			
Field Name	Bits	Default	Description
AARESOLVE_MODE	0	0x0	Specifies if the color buffer is in resolve mode. The cache must be empty before changing this register. <u>POSSIBLE VALUES:</u> 00 - Normal operation. 01 - Resolve operation.
AARESOLVE_GAMMA	1	none	Specifies the gamma and degamma to be applied to the samples before and after filtering, respectively. <u>POSSIBLE VALUES:</u> 00 - 1.0 01 - 2.2
AARESOLVE_ALPHA	2	0x0	Controls whether alpha is averaged in the resolve. 0 => the resolved alpha value is selected from the sample 0 value. 1=> the resolved alpha value is a filtered (average) result of of the samples. <u>POSSIBLE VALUES:</u> 00 - Resolved alpha value is taken from sample 0. 01 - Resolved alpha value is the average of the samples. The average is not gamma corrected.

CB:RB3D_AARESOLVE_OFFSET · [R/W] · 32 bits · Access: 8/16/32 · MMRReg:0x4e80			
DESCRIPTION: <i>Resolve buffer destination address. The cache must be empty before changing this register if the cb is in resolve mode. Unpipelined</i>			
Field Name	Bits	Default	Description
AARESOLVE_OFFSET	31:5	none	256-bit aligned 3D resolve destination offset.

CB:RB3D_AARESOLVE_PITCH · [R/W] · 32 bits · Access: 8/16/32 · MMRReg:0x4e84			
DESCRIPTION: <i>Resolve Buffer Pitch and Tiling Control. The cache must be empty before changing this register if the cb is in resolve mode. Unpipelined</i>			
Field Name	Bits	Default	Description
AARESOLVE_PITCH	13:1	none	3D destination pitch in multiples of 2-pixels.

CB:RB3D_ABLENDCTL · [R/W] · 32 bits · Access: 8/16/32 · MMReg:0x4e08			
DESCRIPTION: <i>Alpha Blend Control for Alpha Channel. Pipelined through the blender.</i>			
Field Name	Bits	Default	Description
COMB_FCN	14:12	none	Combine Function , Allows modification of how the SRCBLEND and DESTBLEND are combined. <u>POSSIBLE VALUES:</u> 00 - Add and Clamp 01 - Add but no Clamp 02 - Subtract Dst from Src, and Clamp 03 - Subtract Dst from Src, and don` t Clamp 04 - Minimum of Src, Dst (the src and dst blend functions are forced to D3D_ONE) 05 - Maximum of Src, Dst (the src and dst blend functions are forced to D3D_ONE) 06 - Subtract Src from Dst, and Clamp 07 - Subtract Src from Dst, and don` t Clamp
SRCBLEND	21:16	none	Source Blend Function , Alpha blending function (SRC). <u>POSSIBLE VALUES:</u> 00 - RESERVED 01 - D3D_ZERO 02 - D3D_ONE 03 - D3D_SRCOLOR 04 - D3D_INVSRCOLOR 05 - D3D_SRCALPHA 06 - D3D_INVSRCALPHA 07 - D3D_DESTALPHA 08 - D3D_INVDESTALPHA 09 - D3D_DESTCOLOR 10 - D3D_INVDESTCOLOR 11 - D3D_SRCALPHASAT 12 - D3D_BOTHSRCALPHA 13 - D3D_BOTHINVSRCALPHA 14 - RESERVED 15 - RESERVED 16 - RESERVED 17 - RESERVED 18 - RESERVED 19 - RESERVED 20 - RESERVED 21 - RESERVED 22 - RESERVED 23 - RESERVED 24 - RESERVED 25 - RESERVED 26 - RESERVED 27 - RESERVED 28 - RESERVED 29 - RESERVED 30 - RESERVED

			<p>31 - RESERVED 32 - GL_ZERO 33 - GL_ONE 34 - GL_SRC_COLOR 35 - GL_ONE_MINUS_SRC_COLOR 36 - GL_DST_COLOR 37 - GL_ONE_MINUS_DST_COLOR 38 - GL_SRC_ALPHA 39 - GL_ONE_MINUS_SRC_ALPHA 40 - GL_DST_ALPHA 41 - GL_ONE_MINUS_DST_ALPHA 42 - GL_SRC_ALPHA_SATURATE 43 - GL_CONSTANT_COLOR 44 - GL_ONE_MINUS_CONSTANT_COLOR 45 - GL_CONSTANT_ALPHA 46 - GL_ONE_MINUS_CONSTANT_ALPHA 47 - RESERVED 48 - RESERVED 49 - RESERVED 50 - RESERVED 51 - RESERVED 52 - RESERVED 53 - RESERVED 54 - RESERVED 55 - RESERVED 56 - RESERVED 57 - RESERVED 58 - RESERVED 59 - RESERVED 60 - RESERVED 61 - RESERVED 62 - RESERVED 63 - RESERVED</p>
DESTBLEND	29:24	none	<p>Destination Blend Function , Alpha blending function (DST).</p> <p><u>POSSIBLE VALUES:</u> 00 - RESERVED 01 - D3D_ZERO 02 - D3D_ONE 03 - D3D_SRC_COLOR 04 - D3D_INVSRC_COLOR 05 - D3D_SRC_ALPHA 06 - D3D_INV_SRC_ALPHA 07 - D3D_DEST_ALPHA 08 - D3D_INV_DEST_ALPHA 09 - D3D_DEST_COLOR 10 - D3D_INV_DEST_COLOR 11 - RESERVED 12 - RESERVED 13 - RESERVED 14 - RESERVED 15 - RESERVED</p>

			16 - RESERVED 17 - RESERVED 18 - RESERVED 19 - RESERVED 20 - RESERVED 21 - RESERVED 22 - RESERVED 23 - RESERVED 24 - RESERVED 25 - RESERVED 26 - RESERVED 27 - RESERVED 28 - RESERVED 29 - RESERVED 30 - RESERVED 31 - RESERVED 32 - GL_ZERO 33 - GL_ONE 34 - GL_SRC_COLOR 35 - GL_ONE_MINUS_SRC_COLOR 36 - GL_DST_COLOR 37 - GL_ONE_MINUS_DST_COLOR 38 - GL_SRC_ALPHA 39 - GL_ONE_MINUS_SRC_ALPHA 40 - GL_DST_ALPHA 41 - GL_ONE_MINUS_DST_ALPHA 42 - RESERVED 43 - GL_CONSTANT_COLOR 44 - GL_ONE_MINUS_CONSTANT_COLOR 45 - GL_CONSTANT_ALPHA 46 - GL_ONE_MINUS_CONSTANT_ALPHA 47 - RESERVED 48 - RESERVED 49 - RESERVED 50 - RESERVED 51 - RESERVED 52 - RESERVED 53 - RESERVED 54 - RESERVED 55 - RESERVED 56 - RESERVED 57 - RESERVED 58 - RESERVED 59 - RESERVED 60 - RESERVED 61 - RESERVED 62 - RESERVED 63 - RESERVED
--	--	--	---

CB:RB3D_BLEND_CNTL · [R/W] · 32 bits · Access: 8/16/32 · MMReg:0x4e04
DESCRIPTION: Alpha Blend Control for Color Channels. Pipelined through the blender.

Field Name	Bits	Default	Description
ALPHA_BLEND_ENABLE	0	0x0	Allow alpha blending with the destination. <u>POSSIBLE VALUES:</u> 00 - Disable 01 - Enable
SEPARATE_ALPHA_ENABLE	1	0x0	Enables use of RB3D_ABLENCNTL <u>POSSIBLE VALUES:</u> 00 - Disabled (Use RB3D_BLENDCNTL) 01 - Enabled (Use RB3D_ABLENCNTL)
READ_ENABLE	2	0x1	When blending is enabled, this enables memory reads. Memory reads will still occur when this is disabled if they are for reasons not related to blending. <u>POSSIBLE VALUES:</u> 00 - Disable reads 01 - Enable reads
DISCARD_SRC_PIXELS	5:3	0x0	Discard pixels when blending is enabled based on the src color. <u>POSSIBLE VALUES:</u> 00 - Disable 01 - Discard pixels if src alpha <= RB3D_DISCARD_SRC_PIXEL_LTE_THRESHOLD 02 - Discard pixels if src color <= RB3D_DISCARD_SRC_PIXEL_LTE_THRESHOLD 03 - Discard pixels if src argb <= RB3D_DISCARD_SRC_PIXEL_LTE_THRESHOLD 04 - Discard pixels if src alpha >= RB3D_DISCARD_SRC_PIXEL_GTE_THRESHOLD 05 - Discard pixels if src color >= RB3D_DISCARD_SRC_PIXEL_GTE_THRESHOLD 06 - Discard pixels if src argb >= RB3D_DISCARD_SRC_PIXEL_GTE_THRESHOLD 07 - (reserved)
COMB_FCN	14:12	none	Combine Function , Allows modification of how the SRCBLEND and DESTBLEND are combined. <u>POSSIBLE VALUES:</u> 00 - Add and Clamp 01 - Add but no Clamp 02 - Subtract Dst from Src, and Clamp 03 - Subtract Dst from Src, and don` t Clamp 04 - Minimum of Src, Dst (the src and dst blend functions are forced to D3D_ONE) 05 - Maximum of Src, Dst (the src and dst blend functions are forced to D3D_ONE) 06 - Subtract Src from Dst, and Clamp 07 - Subtract Src from Dst, and don` t Clamp

SRCBLEND	21:16	none	<p>Source Blend Function , Alpha blending function (SRC).</p> <p><u>POSSIBLE VALUES:</u></p> <ul style="list-style-type: none"> 00 - RESERVED 01 - D3D_ZERO 02 - D3D_ONE 03 - D3D_SRCOLOR 04 - D3D_INVSRCOLOR 05 - D3D_SRCALPHA 06 - D3D_INVSRCALPHA 07 - D3D_DESTALPHA 08 - D3D_INVDESTALPHA 09 - D3D_DESTCOLOR 10 - D3D_INVDESTCOLOR 11 - D3D_SRCALPHASAT 12 - D3D_BOTHSRCALPHA 13 - D3D_BOTHINVSRCALPHA 14 - RESERVED 15 - RESERVED 16 - RESERVED 17 - RESERVED 18 - RESERVED 19 - RESERVED 20 - RESERVED 21 - RESERVED 22 - RESERVED 23 - RESERVED 24 - RESERVED 25 - RESERVED 26 - RESERVED 27 - RESERVED 28 - RESERVED 29 - RESERVED 30 - RESERVED 31 - RESERVED 32 - GL_ZERO 33 - GL_ONE 34 - GL_SRC_COLOR 35 - GL_ONE_MINUS_SRC_COLOR 36 - GL_DST_COLOR 37 - GL_ONE_MINUS_DST_COLOR 38 - GL_SRC_ALPHA 39 - GL_ONE_MINUS_SRC_ALPHA 40 - GL_DST_ALPHA 41 - GL_ONE_MINUS_DST_ALPHA 42 - GL_SRC_ALPHA_SATURATE 43 - GL_CONSTANT_COLOR 44 - GL_ONE_MINUS_CONSTANT_COLOR 45 - GL_CONSTANT_ALPHA 46 - GL_ONE_MINUS_CONSTANT_ALPHA 47 - RESERVED 48 - RESERVED 49 - RESERVED
----------	-------	------	--

			50 - RESERVED 51 - RESERVED 52 - RESERVED 53 - RESERVED 54 - RESERVED 55 - RESERVED 56 - RESERVED 57 - RESERVED 58 - RESERVED 59 - RESERVED 60 - RESERVED 61 - RESERVED 62 - RESERVED 63 - RESERVED
DESTBLEND	29:24	none	Destination Blend Function , Alpha blending function (DST). <u>POSSIBLE VALUES:</u> 00 - RESERVED 01 - D3D_ZERO 02 - D3D_ONE 03 - D3D_SRCOLOR 04 - D3D_INVSRCOLOR 05 - D3D_SRCALPHA 06 - D3D_INVSRCALPHA 07 - D3D_DESTALPHA 08 - D3D_INVDESTALPHA 09 - D3D_DESTCOLOR 10 - D3D_INVDESTCOLOR 11 - RESERVED 12 - RESERVED 13 - RESERVED 14 - RESERVED 15 - RESERVED 16 - RESERVED 17 - RESERVED 18 - RESERVED 19 - RESERVED 20 - RESERVED 21 - RESERVED 22 - RESERVED 23 - RESERVED 24 - RESERVED 25 - RESERVED 26 - RESERVED 27 - RESERVED 28 - RESERVED 29 - RESERVED 30 - RESERVED 31 - RESERVED 32 - GL_ZERO 33 - GL_ONE 34 - GL_SRC_COLOR

			<p>35 - GL_ONE_MINUS_SRC_COLOR 36 - GL_DST_COLOR 37 - GL_ONE_MINUS_DST_COLOR 38 - GL_SRC_ALPHA 39 - GL_ONE_MINUS_SRC_ALPHA 40 - GL_DST_ALPHA 41 - GL_ONE_MINUS_DST_ALPHA 42 - RESERVED 43 - GL_CONSTANT_COLOR 44 - GL_ONE_MINUS_CONSTANT_COLOR 45 - GL_CONSTANT_ALPHA 46 - GL_ONE_MINUS_CONSTANT_ALPHA 47 - RESERVED 48 - RESERVED 49 - RESERVED 50 - RESERVED 51 - RESERVED 52 - RESERVED 53 - RESERVED 54 - RESERVED 55 - RESERVED 56 - RESERVED 57 - RESERVED 58 - RESERVED 59 - RESERVED 60 - RESERVED 61 - RESERVED 62 - RESERVED 63 - RESERVED</p>
SRC_ALPHA_0_NO_READ	30	0x0	<p>Enables source alpha zero performance optimization to skip reads.</p> <p><u>POSSIBLE VALUES:</u> 00 - Disable source alpha zero performance optimization to skip reads 01 - Enable source alpha zero performance optimization to skip reads</p>
SRC_ALPHA_1_NO_READ	31	0x0	<p>Enables source alpha one performance optimization to skip reads.</p> <p><u>POSSIBLE VALUES:</u> 00 - Disable source alpha one performance optimization to skip reads 01 - Enable source alpha one performance optimization to skip reads</p>

CB:RB3D_DISCARD_SRC_PIXEL_GTE_THRESHOLD · [R/W] · 32 bits · Access: 8/16/32 · MMReg:0x4ea4			
DESCRIPTION: <i>Discard src pixels greater than or equal to threshold.</i>			
Field Name	Bits	Default	Description

BLUE	7:0	0xFF	Blue
GREEN	15:8	0xFF	Green
RED	23:16	0xFF	Red
ALPHA	31:24	0xFF	Alpha

CB:RB3D_DISCARD_SRC_PIXEL_LTE_THRESHOLD · [R/W] · 32 bits · Access: 8/16/32 · MMReg:0x4ea0			
DESCRIPTION: <i>Discard src pixels less than or equal to threshold.</i>			
Field Name	Bits	Default	Description
BLUE	7:0	0x0	Blue
GREEN	15:8	0x0	Green
RED	23:16	0x0	Red
ALPHA	31:24	0x0	Alpha

CB:RB3D_CCTL · [R/W] · 32 bits · Access: 8/16/32 · MMReg:0x4e00			
DESCRIPTION: <i>Unpipelined.</i>			
Field Name	Bits	Default	Description
NUM_MULTIWRITES	6:5	0x0	A quad is replicated and written to this many buffers. POSSIBLE VALUES: 00 - 1 buffer. This is the only mode where the cb processes the end of packet command. 01 - 2 buffers 02 - 3 buffers 03 - 4 buffers
CLRCMP_FLIPE_ENABLE	7	0x0	Enables equivalent of rage128 CMP_EQ_FLIP color compare mode. This is used to ensure 3D data does not get chromakeyed away by logic in the backend. POSSIBLE VALUES: 00 - Disable color compare. 01 - Enable color compare.
AA_COMPRESSION_ENABLE	9	none	Enables AA color compression. Cmask must also be enabled when aa compression is enabled. The cache must be empty before this is changed. POSSIBLE VALUES: 00 - Disable AA compression 01 - Enable AA compression

CMASK_ENABLE	10	none	Enables use of the cmask ram. The cache must be empty before this is changed. <u>POSSIBLE VALUES:</u> 00 - Disable 01 - Enable
Reserved	11	0x0	Set to 0
INDEPENDENT_COLOR_CHANNEL_MASK_ENABLE	12	0x0	Enables independent color channel masks for the MRTs. Disabling this feature will cause all the MRTs to use color channel mask 0. <u>POSSIBLE VALUES:</u> 00 - Disable 01 - Enable
WRITE_COMPRESSION_DISABLE	13	none	Disables write compression. <u>POSSIBLE VALUES:</u> 00 - Enable write compression 01 - Disable write compression
INDEPENDENT_COLORFORMAT_ENABLE	14	0x0	Enables independent color format for the MRTs. Disabling this feature will cause all the MRTs to use color format 0. <u>POSSIBLE VALUES:</u> 00 - Disable 01 - Enable

CB:RB3D_CLRCMP_CLR · [R/W] · 32 bits · Access: 8/16/32 · MMReg:0x4e20			
DESCRIPTION: <i>Color Compare Color. Stalls the 2d/3d datapath until it is idle.</i>			
Field Name	Bits	Default	Description
CLRCMP_CLR	31:0	none	Like RB2D_CLRCMP_CLR, but a separate register is provided to keep 2D and 3D state separate.

CB:RB3D_CLRCMP_FLIPE · [R/W] · 32 bits · Access: 8/16/32 · MMReg:0x4e1c			
DESCRIPTION: <i>Color Compare Flip. Stalls the 2d/3d datapath until it is idle.</i>			
Field Name	Bits	Default	Description
CLRCMP_FLIPE	31:0	none	Like RB2D_CLRCMP_FLIPE, but a separate register is provided to keep 2D and 3D state separate.

CB:RB3D_CLRCMP_MSK · [R/W] · 32 bits · Access: 8/16/32 · MMReg:0x4e24			
DESCRIPTION: <i>Color Compare Mask. Stalls the 2d/3d datapath until it is idle.</i>			
Field Name	Bits	Default	Description

CLRCMP_MSK	31:0	none	Like RB2D_CLRCMP_CLR, but separate registers provided to keep 2D and 3D state separate.
------------	------	------	---

CB:RB3D_COLOROFFSET[0-3] · [R/W] · 32 bits · Access: 8/16/32 · MMReg:0x4e28-0x4e34			
DESCRIPTION: <i>Color Buffer Address Offset of multibuffer 0. Unpipelined.</i>			
Field Name	Bits	Default	Description
COLOROFFSET	31:5	none	256-bit aligned 3D destination offset address. The cache must be empty before this is changed.

CB:RB3D_COLORPITCH[0-3] · [R/W] · 32 bits · Access: 8/16/32 · MMReg:0x4e38-0x4e44			
DESCRIPTION: <i>Color buffer format and tiling control for all the multibuffers and the pitch of multibuffer 0. Unpipelined. The cache must be empty before any of the registers are changed.</i>			
Field Name	Bits	Default	Description
COLORPITCH	13:1	none	3D destination pitch in multiples of 2-pixels.
COLORTILE	16	none	Denotes whether the 3D destination is in macrotilled format. <u>POSSIBLE VALUES:</u> 00 - 3D destination is not macrotilled 01 - 3D destination is macrotilled
COLORMICROTILE	18:17	none	Denotes whether the 3D destination is in microtilled format. <u>POSSIBLE VALUES:</u> 00 - 3D destination is no microtilled 01 - 3D destination is microtilled 02 - 3D destination is square microtilled. Only available in 16-bit 03 - (reserved)
COLORENDIAN	20:19	none	Specifies endian control for the color buffer. <u>POSSIBLE VALUES:</u> 00 - No swap 01 - Word swap (2 bytes in 16-bit) 02 - Dword swap (4 bytes in a 32-bit) 03 - Half-Dword swap (2 16-bit in a 32-bit)
COLORFORMAT	24:21	0x6	3D destination color format. <u>POSSIBLE VALUES:</u> 00 - ARGB10101010 01 - UV1010 02 - CI8 (2D ONLY) 03 - ARGB1555 04 - RGB565 05 - ARGB2101010 06 - ARGB8888

			07 - ARGB32323232 08 - (Reserved) 09 - I8 10 - ARGB16161616 11 - YUV422 packed (VYUY) 12 - YUV422 packed (YVYU) 13 - UV88 14 - I10 15 - ARGB4444
--	--	--	--

CB:RB3D_COLOR_CHANNEL_MASK · [R/W] · 32 bits · Access: 8/16/32 · MMReg:0x4e0c			
DESCRIPTION: 3D Color Channel Mask. If all the channels used in the current color format are disabled, then the cb will discard all the incoming quads. Pipelined through the blender.			
Field Name	Bits	Default	Description
BLUE_MASK	0	0x1	mask bit for the blue channel <u>POSSIBLE VALUES:</u> 00 - disable 01 - enable
GREEN_MASK	1	0x1	mask bit for the green channel <u>POSSIBLE VALUES:</u> 00 - disable 01 - enable
RED_MASK	2	0x1	mask bit for the red channel <u>POSSIBLE VALUES:</u> 00 - disable 01 - enable
ALPHA_MASK	3	0x1	mask bit for the alpha channel <u>POSSIBLE VALUES:</u> 00 - disable 01 - enable
BLUE_MASK1	4	0x1	mask bit for the blue channel of MRT 1 <u>POSSIBLE VALUES:</u> 00 - disable 01 - enable
GREEN_MASK1	5	0x1	mask bit for the green channel of MRT 1 <u>POSSIBLE VALUES:</u> 00 - disable 01 - enable
RED_MASK1	6	0x1	mask bit for the red channel of MRT 1 <u>POSSIBLE VALUES:</u>

			00 - disable 01 - enable
ALPHA_MASK1	7	0x1	mask bit for the alpha channel of MRT 1 <u>POSSIBLE VALUES:</u> 00 - disable 01 - enable
BLUE_MASK2	8	0x1	mask bit for the blue channel of MRT 2 <u>POSSIBLE VALUES:</u> 00 - disable 01 - enable
GREEN_MASK2	9	0x1	mask bit for the green channel of MRT 2 <u>POSSIBLE VALUES:</u> 00 - disable 01 - enable
RED_MASK2	10	0x1	mask bit for the red channel of MRT 2 <u>POSSIBLE VALUES:</u> 00 - disable 01 - enable
ALPHA_MASK2	11	0x1	mask bit for the alpha channel of MRT 2 <u>POSSIBLE VALUES:</u> 00 - disable 01 - enable
BLUE_MASK3	12	0x1	mask bit for the blue channel of MRT 3 <u>POSSIBLE VALUES:</u> 00 - disable 01 - enable
GREEN_MASK3	13	0x1	mask bit for the green channel of MRT 3 <u>POSSIBLE VALUES:</u> 00 - disable 01 - enable
RED_MASK3	14	0x1	mask bit for the red channel of MRT 3 <u>POSSIBLE VALUES:</u> 00 - disable 01 - enable
ALPHA_MASK3	15	0x1	mask bit for the alpha channel of MRT 3 <u>POSSIBLE VALUES:</u> 00 - disable 01 - enable

CB:RB3D_COLOR_CLEAR_VALUE · [R/W] · 32 bits · Access: 8/16/32 · MMReg:0x4e14			
DESCRIPTION: Clear color that is used when the color mask is set to 00. Unpipelined. Program this register with a 32-bit value in ARGB8888 or ARGB2101010 formats, ignoring the fields.			
Field Name	Bits	Default	Description
BLUE	7:0	none	blue clear color
GREEN	15:8	none	green clear color
RED	23:16	none	red clear color
ALPHA	31:24	none	alpha clear color

CB:RB3D_COLOR_CLEAR_VALUE_AR · [R/W] · 32 bits · Access: 8/16/32 · MMReg:0x46c0			
DESCRIPTION: Alpha and red clear color values that are used when the color mask is set to 00 in FP16 per component mode. Unpipelined.			
Field Name	Bits	Default	Description
RED	15:0	none	red clear color
ALPHA	31:16	none	alpha clear color

CB:RB3D_COLOR_CLEAR_VALUE_GB · [R/W] · 32 bits · Access: 8/16/32 · MMReg:0x46c4			
DESCRIPTION: Green and blue clear color values that are used when the color mask is set to 00 in FP16 per component mode. Unpipelined.			
Field Name	Bits	Default	Description
BLUE	15:0	none	blue clear color
GREEN	31:16	none	green clear color

CB:RB3D_CONSTANT_COLOR · [R/W] · 32 bits · Access: 8/16/32 · MMReg:0x4e10			
DESCRIPTION: Constant color used by the blender. Pipelined through the blender.			
Field Name	Bits	Default	Description
BLUE	7:0	none	blue constant color (For R520, this field is ignored, use RB3D_CONSTANT_COLOR_GB__BLUE instead)
GREEN	15:8	none	green constant color (For R520, this field is ignored, use RB3D_CONSTANT_COLOR_GB__GREEN instead)
RED	23:16	none	red constant color (For R520, this field is ignored, use RB3D_CONSTANT_COLOR_AR__RED instead)
ALPHA	31:24	none	alpha constant color (For R520, this field is ignored, use RB3D_CONSTANT_COLOR_AR__ALPHA instead)

CB:RB3D_CONSTANT_COLOR_AR · [R/W] · 32 bits · Access: 8/16/32 · MMReg:0x4ef8			
DESCRIPTION: Constant color used by the blender. Pipelined through the blender.			
Field Name	Bits	Default	Description
RED	15:0	none	red constant color in 0.10 fixed or FP16 format

ALPHA	31:16	none	alpha constant color in 0.10 fixed or FP16 format
-------	-------	------	---

CB:RB3D_CONSTANT_COLOR_GB · [R/W] · 32 bits · Access: 8/16/32 · MMReg:0x4efc			
DESCRIPTION: <i>Constant color used by the blender. Pipelined through the blender.</i>			
Field Name	Bits	Default	Description
BLUE	15:0	none	blue constant color in 0.10 fixed or FP16 format
GREEN	31:16	none	green constant color in 0.10 fixed or FP16 format

CB:RB3D_DITHER_CTL · [R/W] · 32 bits · Access: 8/16/32 · MMReg:0x4e50			
DESCRIPTION: <i>Dithering control register. Pipelined through the blender.</i>			
Field Name	Bits	Default	Description
DITHER_MODE	1:0	0x0	Dither mode <u>POSSIBLE VALUES:</u> 00 - Truncate 01 - Round 02 - LUT dither 03 - (reserved)
ALPHA_DITHER_MODE	3:2	0x0	<u>POSSIBLE VALUES:</u> 00 - Truncate 01 - Round 02 - LUT dither 03 - (reserved)

CB:RB3D_DSTCACHE_CTLSTAT · [R/W] · 32 bits · Access: 8/16/32 · MMReg:0x4e4c			
DESCRIPTION: <i>Destination Color Buffer Cache Control/Status. If the cb is in e2 mode, then a flush or free will not occur upon a write to this register, but a sync will be immediately sent if one is requested. If both DC_FLUSH and DC_FREE are zero but DC_FINISH is one, then a sync will be sent immediately -- the cb will not wait for all the previous operations to complete before sending the sync. Unpipelined except when DC_FINISH and DC_FREE are both set to zero.</i>			
Field Name	Bits	Default	Description
DC_FLUSH	1:0	0x0	Setting this bit flushes dirty data from the 3D Dst Cache. Unless the DC_FREE bits are also set, the tags in the cache remain valid. A purge is achieved by setting both DC_FLUSH and DC_FREE. <u>POSSIBLE VALUES:</u> 00 - No effect 01 - No effect 02 - Flushes dirty 3D data 03 - Flushes dirty 3D data
DC_FREE	3:2	0x0	Setting this bit invalidates the 3D Dst Cache tags. Unless the DC_FLUSH bit is also set, the cache lines are not written to memory. A purge is achieved by setting both

			DC_FLUSH and DC_FREE. <u>POSSIBLE VALUES:</u> 00 - No effect 01 - No effect 02 - Free 3D tags 03 - Free 3D tags
DC_FINISH	4	0x0	<u>POSSIBLE VALUES:</u> 00 - do not send a finish signal to the CP 01 - send a finish signal to the CP after the end of operation

CB:RB3D_FIFO_SIZE · [R/W] · 32 bits · Access: 8/16/32 · MMReg:0x4ef4			
DESCRIPTION: Sets the fifo sizes			
Field Name	Bits	Default	Description
OP_FIFO_SIZE	1:0	0x0	Determines the size of the op fifo <u>POSSIBLE VALUES:</u> 00 - Full size 01 - 1/2 size 02 - 1/4 size 03 - 1/8 size

CB:RB3D_ROPCNTL · [R/W] · 32 bits · Access: 8/16/32 · MMReg:0x4e18			
DESCRIPTION: 3D ROP Control. Stalls the 2d/3d datapath until it is idle.			
Field Name	Bits	Default	Description
ROP_ENABLE	2	0x0	<u>POSSIBLE VALUES:</u> 00 - Disable ROP. (Forces ROP2 to be 0xC). 01 - Enabled
ROP	11:8	none	ROP2 code for 3D fragments. This value is replicated into 2 nibbles to form the equivalent ROP3 code to control the ROP3 logic. These are the GDI ROP2 codes.

10.2 Fog Registers

FG:FG_ALPHA_FUNC · [R/W] · 32 bits · Access: 8/16/32 · MMReg:0x4bd4			
DESCRIPTION: <i>Alpha Function</i>			
Field Name	Bits	Default	Description
AF_VAL	7:0	0x0	Specifies the 8-bit alpha compare value when AF_EN_8BIT is enabled
AF_FUNC	10:8	0x0	Specifies the alpha compare function. <u>POSSIBLE VALUES:</u> 00 - AF_NEVER 01 - AF_LESS 02 - AF_EQUAL 03 - AF_LE 04 - AF_GREATER 05 - AF_NOTEQUAL 06 - AF_GE 07 - AF_ALWAYS
AF_EN	11	0x0	Enables/Disables alpha compare function. <u>POSSIBLE VALUES:</u> 00 - Disable alpha function. 01 - Enable alpha function.
AF_EN_8BIT	12	0x0	Enable 8-bit alpha compare function. <u>POSSIBLE VALUES:</u> 00 - Default 10-bit alpha compare. 01 - Enable 8-bit alpha compare.
AM_EN	16	0x0	Enables/Disables alpha-to-mask function. <u>POSSIBLE VALUES:</u> 00 - Disable alpha to mask function. 01 - Enable alpha to mask function.
AM_CFG	17	0x0	Specifies number of sub-pixel samples for alpha-to-mask function. <u>POSSIBLE VALUES:</u> 00 - 2/4 sub-pixel samples. 01 - 3/6 sub-pixel samples.
DITH_EN	20	0x0	Enables/Disables RGB Dithering (Not supported in R520) <u>POSSIBLE VALUES:</u> 00 - Disable Dithering 01 - Enable Dithering.
ALP_OFF_EN	24	0x0	Alpha offset enable/disable (Not supported in R520)

			<p>POSSIBLE VALUES: 00 - Disables alpha offset of 2 (default r300 & rv350 behavior) 01 - Enables offset of 2 on alpha coming in from the US</p>
DISCARD_ZERO_MASK_QUAD	25	0x0	<p>Enable/Disable discard zero mask coverage quad to ZB</p> <p>POSSIBLE VALUES: 00 - No discard of zero coverage mask quads 01 - Discard zero coverage mask quads</p>
FP16_ENABLE	28	0x0	<p>Enables/Disables FP16 alpha function</p> <p>POSSIBLE VALUES: 00 - Default 10-bit alpha compare and alpha-to-mask function 01 - Enable FP16 alpha compare and alpha-to-mask function</p>

FG:FG_ALPHA_VALUE · [R/W] · 32 bits · Access: 8/16/32 · MMReg:0x4be0			
DESCRIPTION: <i>Alpha Compare Value</i>			
Field Name	Bits	Default	Description
AF_VAL	15:0	0x0	Specifies the alpha compare value, 0.10 fixed or FP16 format

FG:FG_DEPTH_SRC · [R/W] · 32 bits · Access: 8/16/32 · MMReg:0x4bd8			
DESCRIPTION: <i>Where does depth come from?</i>			
Field Name	Bits	Default	Description
DEPTH_SRC	0	0x0	<p>POSSIBLE VALUES: 00 - Depth comes from scan converter as plane equation. 01 - Depth comes from shader as four discrete values.</p>

FG:FG_FOG_BLEND · [R/W] · 32 bits · Access: 8/16/32 · MMReg:0x4bc0			
DESCRIPTION: <i>Fog Blending Enable</i>			
Field Name	Bits	Default	Description
ENABLE	0	0x0	<p>Enable for fog blending</p> <p>POSSIBLE VALUES: 00 - Disables fog (output matches input color). 01 - Enables fog.</p>
FN	2:1	0x0	Fog generation function

			POSSIBLE VALUES: 00 - Fog function is linear 01 - Fog function is exponential 02 - Fog function is exponential squared 03 - Fog is derived from constant fog factor
--	--	--	--

FG:FG_FOG_COLOR_B · [R/W] · 32 bits · Access: 8/16/32 · MMReg:0x4bd0			
DESCRIPTION: <i>Blue Component of Fog Color</i>			
Field Name	Bits	Default	Description
BLUE	9:0	0x0	Blue component of fog color; (0.10) fixed format.

FG:FG_FOG_COLOR_G · [R/W] · 32 bits · Access: 8/16/32 · MMReg:0x4bcc			
DESCRIPTION: <i>Green Component of Fog Color</i>			
Field Name	Bits	Default	Description
GREEN	9:0	0x0	Green component of fog color; (0.10) fixed format.

FG:FG_FOG_COLOR_R · [R/W] · 32 bits · Access: 8/16/32 · MMReg:0x4bc8			
DESCRIPTION: <i>Red Component of Fog Color</i>			
Field Name	Bits	Default	Description
RED	9:0	0x0	Red component of fog color; (0.10) fixed format.

FG:FG_FOG_FACTOR · [R/W] · 32 bits · Access: 8/16/32 · MMReg:0x4bc4			
DESCRIPTION: <i>Constant Factor for Fog Blending</i>			
Field Name	Bits	Default	Description
FACTOR	9:0	0x0	Constant fog factor; fixed (0.10) format.

10.3 Geometry Assembly Registers

GA:GA_COLOR_CONTROL · [R/W] · 32 bits · Access: 8/16/32 · MMReg:0x4278			
DESCRIPTION: <i>Specifies per RGB or Alpha shading method.</i>			
Field Name	Bits	Default	Description
RGB0_SHADING	1:0	0x0	Specifies solid, flat or Gouraud shading. <u>POSSIBLE VALUES:</u> 00 - Solid fill color 01 - Flat shading 02 - Gouraud shading
ALPHA0_SHADING	3:2	0x0	Specifies solid, flat or Gouraud shading. <u>POSSIBLE VALUES:</u> 00 - Solid fill color 01 - Flat shading 02 - Gouraud shading
RGB1_SHADING	5:4	0x0	Specifies solid, flat or Gouraud shading. <u>POSSIBLE VALUES:</u> 00 - Solid fill color 01 - Flat shading 02 - Gouraud shading
ALPHA1_SHADING	7:6	0x0	Specifies solid, flat or Gouraud shading. <u>POSSIBLE VALUES:</u> 00 - Solid fill color 01 - Flat shading 02 - Gouraud shading
RGB2_SHADING	9:8	0x0	Specifies solid, flat or Gouraud shading. <u>POSSIBLE VALUES:</u> 00 - Solid fill color 01 - Flat shading 02 - Gouraud shading
ALPHA2_SHADING	11:10	0x0	Specifies solid, flat or Gouraud shading. <u>POSSIBLE VALUES:</u> 00 - Solid fill color 01 - Flat shading 02 - Gouraud shading
RGB3_SHADING	13:12	0x0	Specifies solid, flat or Gouraud shading. <u>POSSIBLE VALUES:</u> 00 - Solid fill color 01 - Flat shading 02 - Gouraud shading

ALPHA3_SHADING	15:14	0x0	Specifies solid, flat or Gouraud shading. <u>POSSIBLE VALUES:</u> 00 - Solid fill color 01 - Flat shading 02 - Gouraud shading
PROVOKING_VERTEX	17:16	0x0	Specifies, for flat shaded polygons, which vertex holds the polygon color. <u>POSSIBLE VALUES:</u> 00 - Provoking is first vertex 01 - Provoking is second vertex 02 - Provoking is third vertex 03 - Provoking is always last vertex

GA:GA_COLOR_CONTROL_PS3 · [R/W] · 32 bits · Access: 8/16/32 · MMReg:0x4258			
DESCRIPTION: <i>Specifies color properties and mappings of textures.</i>			
Field Name	Bits	Default	Description
TEX0_SHADING_PS3	1:0	0x0	Specifies undefined(0), flat(1) and Gouraud(2/def) shading for each texture. <u>POSSIBLE VALUES:</u> 00 - Solid fill color 01 - Flat shading 02 - Gouraud shading
TEX1_SHADING_PS3	3:2	0x0	Specifies undefined(0), flat(1) and Gouraud(2/def) shading for each texture. <u>POSSIBLE VALUES:</u> 00 - Solid fill color 01 - Flat shading 02 - Gouraud shading
TEX2_SHADING_PS3	5:4	0x0	Specifies undefined(0), flat(1) and Gouraud(2/def) shading for each texture. <u>POSSIBLE VALUES:</u> 00 - Solid fill color 01 - Flat shading 02 - Gouraud shading
TEX3_SHADING_PS3	7:6	0x0	Specifies undefined(0), flat(1) and Gouraud(2/def) shading for each texture. <u>POSSIBLE VALUES:</u> 00 - Solid fill color 01 - Flat shading 02 - Gouraud shading
TEX4_SHADING_PS3	9:8	0x0	Specifies undefined(0), flat(1) and Gouraud(2/def) shading for each texture.

			<u>POSSIBLE VALUES:</u> 00 - Solid fill color 01 - Flat shading 02 - Gouraud shading
TEX5_SHADING_PS3	11:10	0x0	Specifies undefined(0), flat(1) and Gouraud(2/def) shading for each texture. <u>POSSIBLE VALUES:</u> 00 - Solid fill color 01 - Flat shading 02 - Gouraud shading
TEX6_SHADING_PS3	13:12	0x0	Specifies undefined(0), flat(1) and Gouraud(2/def) shading for each texture. <u>POSSIBLE VALUES:</u> 00 - Solid fill color 01 - Flat shading 02 - Gouraud shading
TEX7_SHADING_PS3	15:14	0x0	Specifies undefined(0), flat(1) and Gouraud(2/def) shading for each texture. <u>POSSIBLE VALUES:</u> 00 - Solid fill color 01 - Flat shading 02 - Gouraud shading
TEX8_SHADING_PS3	17:16	0x0	Specifies undefined(0), flat(1) and Gouraud(2/def) shading for each texture. <u>POSSIBLE VALUES:</u> 00 - Solid fill color 01 - Flat shading 02 - Gouraud shading
TEX9_SHADING_PS3	19:18	0x0	Specifies undefined(0), flat(1) and Gouraud(2/def) shading for each texture. <u>POSSIBLE VALUES:</u> 00 - Solid fill color 01 - Flat shading 02 - Gouraud shading
TEX10_SHADING_PS3	21:20	0x0	Specifies undefined(0), flat(1) and Gouraud(2/def) shading for tex10 components. <u>POSSIBLE VALUES:</u> 00 - Solid fill color 01 - Flat shading 02 - Gouraud shading
COLOR0_TEX_OVERRIDE	25:22	0x0	Specifies if each color should come from a texture and which one.

			<p><u>POSSIBLE VALUES:</u></p> <ul style="list-style-type: none"> 00 - No override 01 - Stuff texture 0 02 - Stuff texture 1 03 - Stuff texture 2 04 - Stuff texture 3 05 - Stuff texture 4 06 - Stuff texture 5 07 - Stuff texture 6 08 - Stuff texture 7 09 - Stuff texture 8/C2 10 - Stuff texture 9/C3
COLOR1_TEX_OVERRIDE	29:26	0x0	<p>Specifies if each color should come from a texture and which one.</p> <p><u>POSSIBLE VALUES:</u></p> <ul style="list-style-type: none"> 00 - No override 01 - Stuff texture 0 02 - Stuff texture 1 03 - Stuff texture 2 04 - Stuff texture 3 05 - Stuff texture 4 06 - Stuff texture 5 07 - Stuff texture 6 08 - Stuff texture 7 09 - Stuff texture 8/C2 10 - Stuff texture 9/C3

GA:GA_ENHANCE · [R/W] · 32 bits · Access: 8/16/32 · MMReg:0x4274			
DESCRIPTION: <i>GA Enhancement Register</i>			
Field Name	Bits	Default	Description
DEADLOCK_CNTL	0	0x0	<p>TCL/GA Deadlock control.</p> <p><u>POSSIBLE VALUES:</u></p> <ul style="list-style-type: none"> 00 - No effect. 01 - Prevents TCL interface from deadlocking on GA side.
FASTSYNC_CNTL	1	0x1	<p>Enables Fast register/primitive switching</p> <p><u>POSSIBLE VALUES:</u></p> <ul style="list-style-type: none"> 00 - No effect. 01 - Enables high-performance register/primitive switching.
REG_READWRITE	2	0x0	<p>R520+: When set, GA supports simultaneous register reads & writes</p> <p><u>POSSIBLE VALUES:</u></p>

			00 - No effect. 01 - Enables GA support of simultaneous register reads and writes.
REG_NOSTALL	3	0x0	<u>POSSIBLE VALUES:</u> 00 - No effect. 01 - Enables GA support of no-stall reads for register read back.

GA:GA_FIFO_CNTL · [R/W] · 32 bits · Access: 8/16/32 · MMReg:0x4270			
DESCRIPTION: <i>GA Input fifo high water marks</i>			
Field Name	Bits	Default	Description
VERTEX_FIFO	2:0	0x0	Number of words remaining in input vertex fifo before asserting nearly full
INDEX_FIFO	5:3	0x0	Number of words remaining in input primitive fifo before asserting nearly full
REG_FIFO	13:6	0x0	Number of words remaining in input register fifo before asserting nearly full

GA:GA_FILL_A · [R/W] · 32 bits · Access: 8/16/32 · MMReg:0x422c			
DESCRIPTION: <i>Alpha fill color</i>			
Field Name	Bits	Default	Description
COLOR_ALPHA	31:0	0x0	FP20 format for alpha fill.

GA:GA_FILL_B · [R/W] · 32 bits · Access: 8/16/32 · MMReg:0x4228			
DESCRIPTION: <i>Blue fill color</i>			
Field Name	Bits	Default	Description
COLOR_BLUE	31:0	0x0	FP20 format for blue fill.

GA:GA_FILL_G · [R/W] · 32 bits · Access: 8/16/32 · MMReg:0x4224			
DESCRIPTION: <i>Green fill color</i>			
Field Name	Bits	Default	Description
COLOR_GREEN	31:0	0x0	FP20 format for green fill.

GA:GA_FILL_R · [R/W] · 32 bits · Access: 8/16/32 · MMReg:0x4220			
DESCRIPTION: <i>Red fill color</i>			
Field Name	Bits	Default	Description
COLOR_RED	31:0	0x0	FP20 format for red fill.

GA:GA_FOG_OFFSET · [R/W] · 32 bits · Access: 8/16/32 · MMReg:0x4298			
DESCRIPTION: <i>Specifies the offset to apply to fog.</i>			
Field Name	Bits	Default	Description
VALUE	31:0	0x0	32b SPFP scale value.

GA:GA_FOG_SCALE · [R/W] · 32 bits · Access: 8/16/32 · MMReg:0x4294			
DESCRIPTION: <i>Specifies the scale to apply to fog.</i>			
Field Name	Bits	Default	Description
VALUE	31:0	0x0	32b SPFP scale value.

GA:GA_IDLE · [R/W] · 32 bits · Access: 8/16/32 · MMReg:0x425c			
DESCRIPTION: <i>Returns idle status of various G3D block, captured when GA_IDLE written or when hard or soft reset asserted.</i>			
Field Name	Bits	Default	Description
PIPE3_Z_IDLE	0	0x0	Idle status of physical pipe 3 Z unit
PIPE2_Z_IDLE	1	0x0	Idle status of physical pipe 2 Z unit
PIPE3_CB_IDLE	2	0x0	Idle status of physical pipe 3 CB unit
PIPE2_CB_IDLE	3	0x0	Idle status of physical pipe 2 CB unit
PIPE3_FG_IDLE	4	0x0	Idle status of physical pipe 3 FG unit
PIPE2_FG_IDLE	5	0x0	Idle status of physical pipe 2 FG unit
PIPE3_US_IDLE	6	0x0	Idle status of physical pipe 3 US unit
PIPE2_US_IDLE	7	0x0	Idle status of physical pipe 2 US unit
PIPE3_SC_IDLE	8	0x0	Idle status of physical pipe 3 SC unit
PIPE2_SC_IDLE	9	0x0	Idle status of physical pipe 2 SC unit
PIPE3_RS_IDLE	10	0x0	Idle status of physical pipe 3 RS unit
PIPE2_RS_IDLE	11	0x0	Idle status of physical pipe 2 RS unit
PIPE1_Z_IDLE	12	0x0	Idle status of physical pipe 1 Z unit
PIPE0_Z_IDLE	13	0x0	Idle status of physical pipe 0 Z unit
PIPE1_CB_IDLE	14	0x0	Idle status of physical pipe 1 CB unit
PIPE0_CB_IDLE	15	0x0	Idle status of physical pipe 0 CB unit
PIPE1_FG_IDLE	16	0x0	Idle status of physical pipe 1 FG unit
PIPE0_FG_IDLE	17	0x0	Idle status of physical pipe 0 FG unit
PIPE1_US_IDLE	18	0x0	Idle status of physical pipe 1 US unit
PIPE0_US_IDLE	19	0x0	Idle status of physical pipe 0 US unit
PIPE1_SC_IDLE	20	0x0	Idle status of physical pipe 1 SC unit
PIPE0_SC_IDLE	21	0x0	Idle status of physical pipe 0 SC unit
PIPE1_RS_IDLE	22	0x0	Idle status of physical pipe 1 RS unit
PIPE0_RS_IDLE	23	0x0	Idle status of physical pipe 0 RS unit

SU_IDLE	24	0x0	Idle status of SU unit
GA_IDLE	25	0x0	Idle status of GA unit
GA_UNIT2_IDLE	26	0x0	Idle status of GA unit2

GA:GA_LINE_CNTL · [R/W] · 32 bits · Access: 8/16/32 · MMReg:0x4234			
DESCRIPTION: <i>Line control</i>			
Field Name	Bits	Default	Description
WIDTH	15:0	0x0	1/2 width of line, in subpixels (1/12 or 1/16 only, even in 8b subprecision); (16.0) fixed format.
END_TYPE	17:16	0x0	Specifies how ends of lines should be drawn. <u>POSSIBLE VALUES:</u> 00 - Horizontal 01 - Vertical 02 - Square (horizontal or vertical depending upon slope) 03 - Computed (perpendicular to slope)
SORT	18	0x0	R520+: When enabled, all lines are sorted so that V0 is vertex with smallest X, or if X equal, smallest Y. <u>POSSIBLE VALUES:</u> 00 - No sorting (default) 01 - Sort on minX than MinY

GA:GA_LINE_S0 · [R/W] · 32 bits · Access: 8/16/32 · MMReg:0x4264			
DESCRIPTION: <i>S Texture Coordinate Value for Vertex 0 of Line (stuff textures -- i.e. AA)</i>			
Field Name	Bits	Default	Description
S0	31:0	0x0	S texture coordinate value generated for vertex 0 of an antialiased line; 32-bit IEEE float format. Typical 0.0.

GA:GA_LINE_S1 · [R/W] · 32 bits · Access: 8/16/32 · MMReg:0x4268			
DESCRIPTION: <i>S Texture Coordinate Value for Vertex 1 of Lines (V2 of parallelogram -- stuff textures -- i.e. AA)</i>			
Field Name	Bits	Default	Description
S1	31:0	0x0	S texture coordinate value generated for vertex 1 of an antialiased line; 32-bit IEEE float format. Typical 1.0.

GA:GA_LINE_STIPPLE_CONFIG · [R/W] · 32 bits · Access: 8/16/32 · MMReg:0x4238			
DESCRIPTION: <i>Line Stipple configuration information.</i>			
Field Name	Bits	Default	Description
LINE_RESET	1:0	0x0	Specify type of reset to use for stipple accumulation.

			<p><u>POSSIBLE VALUES:</u> 00 - No resetting 01 - Reset per line 02 - Reset per packet</p>
STIPPLE_SCALE	31:2	0x0	Specifies, in truncated (30b) floating point, scale to apply to generated texture coordinates.

GA:GA_LINE_STIPPLE_VALUE · [R/W] · 32 bits · Access: 8/16/32 · MMReg:0x4260			
DESCRIPTION: <i>Current value of stipple accumulator.</i>			
Field Name	Bits	Default	Description
STIPPLE_VALUE	31:0	0x0	24b Integer, measuring stipple accumulation in subpixels (1/12 or 1/16, even in 8b precision). (note: field is 32b, but only lower 24b used)

GA:GA_OFFSET · [R/W] · 32 bits · Access: 8/16/32 · MMReg:0x4290			
DESCRIPTION: <i>Specifies x & y offsets for vertex data after conversion to FP.</i>			
Field Name	Bits	Default	Description
X_OFFSET	15:0	0x0	Specifies X offset in S15 format (subpixels -- 1/12 or 1/16, even in 8b subprecision).
Y_OFFSET	31:16	0x0	Specifies Y offset in S15 format (subpixels -- 1/12 or 1/16, even in 8b subprecision).

GA:GA_POINT_MINMAX · [R/W] · 32 bits · Access: 8/16/32 · MMReg:0x4230			
DESCRIPTION: <i>Specifies maximum and minimum point & sprite sizes for per vertex size specification.</i>			
Field Name	Bits	Default	Description
MIN_SIZE	15:0	0x0	Minimum point & sprite radius (in subsamples) size to allow.
MAX_SIZE	31:16	0x0	Maximum point & sprite radius (in subsamples) size to allow.

GA:GA_POINT_S0 · [R/W] · 32 bits · Access: 8/16/32 · MMReg:0x4200			
DESCRIPTION: <i>S Texture Coordinate of Vertex 0 for Point texture stuffing (LLC)</i>			
Field Name	Bits	Default	Description
S0	31:0	0x0	S texture coordinate of vertex 0 for point; 32-bit IEEE float format.

GA:GA_POINT_S1 · [R/W] · 32 bits · Access: 8/16/32 · MMReg:0x4208			
DESCRIPTION: <i>S Texture Coordinate of Vertex 2 for Point texture stuffing (URC)</i>			

Field Name	Bits	Default	Description
S1	31:0	0x0	S texture coordinate of vertex 2 for point; 32-bit IEEE float format.

GA:GA_POINT_SIZE · [R/W] · 32 bits · Access: 8/16/32 · MMReg:0x421c			
DESCRIPTION: <i>Dimensions for Points</i>			
Field Name	Bits	Default	Description
HEIGHT	15:0	0x0	1/2 Height of point; fixed (16.0), subpixel format (1/12 or 1/16, even if in 8b precision).
WIDTH	31:16	0x0	1/2 Width of point; fixed (16.0), subpixel format (1/12 or 1/16, even if in 8b precision)

GA:GA_POINT_T0 · [R/W] · 32 bits · Access: 8/16/32 · MMReg:0x4204			
DESCRIPTION: <i>T Texture Coordinate of Vertex 0 for Point texture stuffing (LLC)</i>			
Field Name	Bits	Default	Description
T0	31:0	0x0	T texture coordinate of vertex 0 for point; 32-bit IEEE float format.

GA:GA_POINT_T1 · [R/W] · 32 bits · Access: 8/16/32 · MMReg:0x420c			
DESCRIPTION: <i>T Texture Coordinate of Vertex 2 for Point texture stuffing (URC)</i>			
Field Name	Bits	Default	Description
T1	31:0	0x0	T texture coordinate of vertex 2 for point; 32-bit IEEE float format.

GA:GA_POLY_MODE · [R/W] · 32 bits · Access: 8/16/32 · MMReg:0x4288			
DESCRIPTION: <i>Polygon Mode</i>			
Field Name	Bits	Default	Description
POLY_MODE	1:0	0x0	Polygon mode enable. POSSIBLE VALUES: 00 - Disable poly mode (render triangles). 01 - Dual mode (send 2 sets of 3 polys with specified poly type). 02 - Reserved
FRONT_PTYPE	6:4	0x0	Specifies how to render front-facing polygons. POSSIBLE VALUES: 00 - Draw points. 01 - Draw lines. 02 - Draw triangles. 03 - Reserved 3 - 7.

BACK_PTYPE	9:7	0x0	Specifies how to render back-facing polygons. <u>POSSIBLE VALUES:</u> 00 - Draw points. 01 - Draw lines. 02 - Draw triangles. 03 - Reserved 3 - 7.
------------	-----	-----	---

GA:GA_ROUND_MODE · [R/W] · 32 bits · Access: 8/16/32 · MMReg:0x428c			
DESCRIPTION: <i>Specifies the rounding mode for geometry & color SPFP to FP conversions.</i>			
Field Name	Bits	Default	Description
GEOMETRY_ROUND	1:0	0x0	Trunc (0) or round to nearest (1) for geometry (XY). <u>POSSIBLE VALUES:</u> 00 - Round to trunc 01 - Round to nearest
COLOR_ROUND	3:2	0x0	When set, FP32 to FP20 using round to nearest; otherwise trunc <u>POSSIBLE VALUES:</u> 00 - Round to trunc 01 - Round to nearest
RGB_CLAMP	4	0x0	Specifies SPFP color clamp range of [0,1] or FP20 for RGB. <u>POSSIBLE VALUES:</u> 00 - Clamp to [0,1.0] for RGB 01 - RGB is FP20
ALPHA_CLAMP	5	0x0	Specifies SPFP alpha clamp range of [0,1] or FP20. <u>POSSIBLE VALUES:</u> 00 - Clamp to [0,1.0] for Alpha 01 - Alpha is FP20
GEOMETRY_MASK	9:6	0x0	4b negative polarity mask for subpixel precision. Inverted version gets ANDed with subpixel X, Y masks.

GA:GA_SOLID_BA · [R/W] · 32 bits · Access: 8/16/32 · MMReg:0x4280			
DESCRIPTION: <i>Specifies blue & alpha components of fill color -- S312 format -- Backwards comp.</i>			
Field Name	Bits	Default	Description
COLOR_ALPHA	15:0	0x0	Component alpha value. (S3.12)
COLOR_BLUE	31:16	0x0	Component blue value. (S3.12)

GA:GA_SOLID_RG · [R/W] · 32 bits · Access: 8/16/32 · MMReg:0x427c			
---	--	--	--

DESCRIPTION: <i>Specifies red & green components of fill color -- S312 format -- Backwards comp.</i>			
Field Name	Bits	Default	Description
COLOR_GREEN	15:0	0x0	Component green value (S3.12).
COLOR_RED	31:16	0x0	Component red value (S3.12).

GA:GA_TRIANGLE_STIPPLE · [R/W] · 32 bits · Access: 8/16/32 · MMReg:0x4214			
DESCRIPTION: <i>Specifies amount to shift integer position of vertex (screen space) before converting to float for triangle stipple.</i>			
Field Name	Bits	Default	Description
X_SHIFT	3:0	0x0	Amount to shift x position before conversion to SPFP.
Y_SHIFT	19:16	0x0	Amount to shift y position before conversion to SPFP.

GA:GA_US_VECTOR_DATA · [R/W] · 32 bits · Access: 8/16/32 · MMReg:0x4254			
DESCRIPTION: <i>Data register for loading US instructions and constants</i>			
Field Name	Bits	Default	Description
DATA	31:0	0x0	32 bit dword

GA:GA_US_VECTOR_INDEX · [R/W] · 32 bits · Access: 8/16/32 · MMReg:0x4250			
DESCRIPTION: <i>Used to load US instructions and constants</i>			
Field Name	Bits	Default	Description
INDEX	8:0	0x0	Instruction (TYPE == GA_US_VECTOR_INST) or constant (TYPE == GA_US_VECTOR_CONST) number at which to start loading. The GA will then expect n*6 (instructions) or n*4 (constants) writes to GA_US_VECTOR_DATA. The GA will self-increment until this register is written again. For instructions, the GA expects the dwords in the following order: US_CMN_INST, US_ALU_RGB_ADDR, US_ALU_ALPHA_ADDR, US_ALU_ALPHA, US_RGB_INST, US_ALPHA_INST, US_RGBA_INST. For constants, the GA expects the dwords in RGBA order.
TYPE	16	0x0	Specifies if the GA should load instructions or constants. POSSIBLE VALUES: 00 - Load instructions - INDEX is an instruction index 01 - Load constants - INDEX is a constant index
CLAMP	17	0x0	POSSIBLE VALUES: 00 - No clamping of data - Default 01 - Clamp to [-1.0,1.0] constant data

10.4 Graphics Backend Registers

GB:GB_AA_CONFIG · [R/W] · 32 bits · Access: 8/16/32 · MMReg:0x4020			
DESCRIPTION: Specifies the graphics pipeline configuration for antialiasing.			
Field Name	Bits	Default	Description
AA_ENABLE	0	0x0	Enables antialiasing. <u>POSSIBLE VALUES:</u> 00 - Antialiasing disabled(def) 01 - Antialiasing enabled
NUM_AA_SUBSAMPLES	2:1	0x0	Specifies the number of subsamples to use while antialiasing. <u>POSSIBLE VALUES:</u> 00 - 2 subsamples 01 - 3 subsamples 02 - 4 subsamples 03 - 6 subsamples

GB:GB_ENABLE · [R/W] · 32 bits · Access: 8/16/32 · MMReg:0x4008			
DESCRIPTION: Specifies top of Raster pipe specific enable controls.			
Field Name	Bits	Default	Description
POINT_STUFF_ENABLE	0	0x0	Specifies if points will have stuffed texture coordinates. <u>POSSIBLE VALUES:</u> 00 - Disable point texture stuffing. 01 - Enable point texture stuffing.
LINE_STUFF_ENABLE	1	0x0	Specifies if lines will have stuffed texture coordinates. <u>POSSIBLE VALUES:</u> 00 - Disable line texture stuffing. 01 - Enable line texture stuffing.
TRIANGLE_STUFF_ENABLE	2	0x0	Specifies if triangles will have stuffed texture coordinates. <u>POSSIBLE VALUES:</u> 00 - Disable triangle texture stuffing. 01 - Enable triangle texture stuffing.
STENCIL_AUTO	5:4	0x0	Specifies if the auto dec/inc stencil mode should be enabled, and how. <u>POSSIBLE VALUES:</u> 00 - Disable stencil auto inc/dec (def). 01 - Enable stencil auto inc/dec based on triangle cw/ccw, force into dzy low bit. 02 - Force 0 into dzy low bit.

TEX0_SOURCE	17:16	0x0	<p>Specifies the sources of the texture coordinates for each texture.</p> <p><u>POSSIBLE VALUES:</u></p> <ul style="list-style-type: none"> 00 - Replicate VAP source texture coordinates (S,T,[R,Q]). 01 - Stuff with source texture coordinates (S,T). 02 - Stuff with source texture coordinates (S,T,R).
TEX1_SOURCE	19:18	0x0	<p>Specifies the sources of the texture coordinates for each texture.</p> <p><u>POSSIBLE VALUES:</u></p> <ul style="list-style-type: none"> 00 - Replicate VAP source texture coordinates (S,T,[R,Q]). 01 - Stuff with source texture coordinates (S,T). 02 - Stuff with source texture coordinates (S,T,R).
TEX2_SOURCE	21:20	0x0	<p>Specifies the sources of the texture coordinates for each texture.</p> <p><u>POSSIBLE VALUES:</u></p> <ul style="list-style-type: none"> 00 - Replicate VAP source texture coordinates (S,T,[R,Q]). 01 - Stuff with source texture coordinates (S,T). 02 - Stuff with source texture coordinates (S,T,R).
TEX3_SOURCE	23:22	0x0	<p>Specifies the sources of the texture coordinates for each texture.</p> <p><u>POSSIBLE VALUES:</u></p> <ul style="list-style-type: none"> 00 - Replicate VAP source texture coordinates (S,T,[R,Q]). 01 - Stuff with source texture coordinates (S,T). 02 - Stuff with source texture coordinates (S,T,R).
TEX4_SOURCE	25:24	0x0	<p>Specifies the sources of the texture coordinates for each texture.</p> <p><u>POSSIBLE VALUES:</u></p> <ul style="list-style-type: none"> 00 - Replicate VAP source texture coordinates (S,T,[R,Q]). 01 - Stuff with source texture coordinates (S,T). 02 - Stuff with source texture coordinates (S,T,R).
TEX5_SOURCE	27:26	0x0	<p>Specifies the sources of the texture coordinates for each texture.</p> <p><u>POSSIBLE VALUES:</u></p> <ul style="list-style-type: none"> 00 - Replicate VAP source texture coordinates (S,T,[R,Q]). 01 - Stuff with source texture coordinates (S,T). 02 - Stuff with source texture coordinates (S,T,R).
TEX6_SOURCE	29:28	0x0	<p>Specifies the sources of the texture coordinates for each texture.</p>

			<p><u>POSSIBLE VALUES:</u> 00 - Replicate VAP source texture coordinates (S,T,[R,Q]). 01 - Stuff with source texture coordinates (S,T). 02 - Stuff with source texture coordinates (S,T,R).</p>
TEX7_SOURCE	31:30	0x0	<p>Specifies the sources of the texture coordinates for each texture.</p> <p><u>POSSIBLE VALUES:</u> 00 - Replicate VAP source texture coordinates (S,T,[R,Q]). 01 - Stuff with source texture coordinates (S,T). 02 - Stuff with source texture coordinates (S,T,R).</p>

GB:GB_FIFO_SIZE · [R/W] · 32 bits · Access: 8/16/32 · MMReg:0x4024			
DESCRIPTION: Specifies the sizes of the various FIFO's in the sc/rs/us. This register must be the first one written			
Field Name	Bits	Default	Description
SC_IFIFO_SIZE	1:0	0x0	Size of scan converter input FIFO (XYZ) <u>POSSIBLE VALUES:</u> 00 - 32 words 01 - 64 words 02 - 128 words 03 - 256 words
SC_TZFIFO_SIZE	3:2	0x0	Size of scan converter top-of-pipe Z FIFO <u>POSSIBLE VALUES:</u> 00 - 16 words 01 - 32 words 02 - 64 words 03 - 128 words
SC_BFIFO_SIZE	5:4	0x0	Size of scan converter input FIFO (B) <u>POSSIBLE VALUES:</u> 00 - 32 words 01 - 64 words 02 - 128 words 03 - 256 words
RS_TFIFO_SIZE	7:6	0x0	Size of ras input FIFO (Texture) <u>POSSIBLE VALUES:</u> 00 - 64 words 01 - 128 words 02 - 256 words 03 - 512 words
RS_CFIFO_SIZE	9:8	0x0	Size of ras input FIFO (Color)

			<u>POSSIBLE VALUES:</u> 00 - 64 words 01 - 128 words 02 - 256 words 03 - 512 words
US_RAM_SIZE	11:10	0x0	Size of us RAM <u>POSSIBLE VALUES:</u> 00 - 64 words 01 - 128 words 02 - 256 words 03 - 512 words
US_OFIFO_SIZE	13:12	0x0	Size of us output FIFO (RGBA) <u>POSSIBLE VALUES:</u> 00 - 16 words 01 - 32 words 02 - 64 words 03 - 128 words
US_WFIFO_SIZE	15:14	0x0	Size of us output FIFO (W) <u>POSSIBLE VALUES:</u> 00 - 16 words 01 - 32 words 02 - 64 words 03 - 128 words
RS_HIGHWATER_COL	18:16	0x0	High water mark for RS colors` fifo -- NOT USED
RS_HIGHWATER_TEX	21:19	0x0	High water mark for RS textures` fifo -- NOT USED
US_OFIFO_HIGHWATER	23:22	0x0	High water mark for US output fifo <u>POSSIBLE VALUES:</u> 00 - 0 words 01 - 4 words 02 - 8 words 03 - 12 words
US_CUBE_FIFO_HIGHWATER	28:24	0x0	High water mark for US cube map fifo

GB:GB_FIFO_SIZE1 · [R/W] · 32 bits · Access: 8/16/32 · MMRReg:0x4070			
DESCRIPTION: <i>Specifies the sizes of the various FIFO`s in the sc/rs.</i>			
Field Name	Bits	Default	Description
SC_HIGHWATER_IFIFO	5:0	0x0	High water mark for SC input fifo
SC_HIGHWATER_BFIFO	11:6	0x0	High water mark for SC input fifo (B)
RS_HIGHWATER_COL	17:12	0x0	High water mark for RS colors` fifo
RS_HIGHWATER_TEX	23:18	0x0	High water mark for RS textures` fifo

GB:GB_MSPOS0 · [R/W] · 32 bits · Access: 8/16/32 · MMReg:0x4010			
DESCRIPTION: <i>Specifies the position of multisamples 0 through 2</i>			
Field Name	Bits	Default	Description
MS_X0	3:0	0x0	Specifies the x and y position (in subpixels) of multisample 0
MS_Y0	7:4	0x0	Specifies the x and y position (in subpixels) of multisample 0
MS_X1	11:8	0x0	Specifies the x and y position (in subpixels) of multisample 1
MS_Y1	15:12	0x0	Specifies the x and y position (in subpixels) of multisample 1
MS_X2	19:16	0x0	Specifies the x and y position (in subpixels) of multisample 2
MS_Y2	23:20	0x0	Specifies the x and y position (in subpixels) of multisample 2
MSBD0_Y	27:24	0x0	Specifies the minimum x and y distance (in subpixels) between the pixel edge and the multisamples. These values are used in the first (coarse) scan converter
MSBD0_X	31:28	0x0	Specifies the minimum x and y distance (in subpixels) between the pixel edge and the multisamples. These values are used in the first (coarse) scan converter

GB:GB_MSPOS1 · [R/W] · 32 bits · Access: 8/16/32 · MMReg:0x4014			
DESCRIPTION: <i>Specifies the position of multisamples 3 through 5</i>			
Field Name	Bits	Default	Description
MS_X3	3:0	0x0	Specifies the x and y position (in subpixels) of multisample 3
MS_Y3	7:4	0x0	Specifies the x and y position (in subpixels) of multisample 3
MS_X4	11:8	0x0	Specifies the x and y position (in subpixels) of multisample 4
MS_Y4	15:12	0x0	Specifies the x and y position (in subpixels) of multisample 4
MS_X5	19:16	0x0	Specifies the x and y position (in subpixels) of multisample 5
MS_Y5	23:20	0x0	Specifies the x and y position (in subpixels) of multisample 5
MSBD1	27:24	0x0	Specifies the minimum distance (in subpixels) between the pixel edge and the multisamples. This value is used in the second (quad) scan converter

GB:GB_PIPE_SELECT · [R/W] · 32 bits · Access: 8/16/32 · MMReg:0x402c			
DESCRIPTION: <i>Selects which of 4 pipes are active.</i>			

Field Name	Bits	Default	Description
PIPE0_ID	1:0	0x0	Maps physical pipe 0 to logical pipe ID (def 0).
PIPE1_ID	3:2	0x1	Maps physical pipe 1 to logical pipe ID (def 1).
PIPE2_ID	5:4	0x2	Maps physical pipe 2 to logical pipe ID (def 2).
PIPE3_ID	7:6	0x3	Maps physical pipe 3 to logical pipe ID (def 3).
PIPE_MASK	11:8	0x0	4b mask, indicates which physical pipes are enabled (def none=0x0) -- B3=P3, B2=P2, B1=P1, B0=P0. -- 1: enabled, 0: disabled
MAX_PIPE	13:12	0x3	2b, indicates, by the fuses, the max number of allowed pipes. 0 = 1 pipe ... 3 = 4 pipes -- Read Only
BAD_PIPES	17:14	0xF	4b, indicates, by the fuses, the bad pipes: B3=P3, B2=P2, B1=P1, B0=P0 -- 1: bad, 0: good -- Read Only
CONFIG_PIPES	18	0x0	If this bit is set when writing this register, the logical pipe ID values are assigned automatically based on the values that are read back in the MAX_PIPE and BAD_PIPES fields. This field is always read back as 0. <u>POSSIBLE VALUES:</u> 00 - Do nothing 01 - Force self-configuration

GB:GB_SELECT · [R/W] · 32 bits · Access: 8/16/32 · MMReg:0x401c			
DESCRIPTION: Specifies various polygon specific selects (fog, depth, perspective).			
Field Name	Bits	Default	Description
FOG_SELECT	2:0	0x0	Specifies source for outgoing (GA to SU) fog value. <u>POSSIBLE VALUES:</u> 00 - Select C0A 01 - Select C1A 02 - Select C2A 03 - Select C3A 04 - Select 1/(1/W) 05 - Select Z
DEPTH_SELECT	3	0x0	Specifies source for outgoing (GA/SU & SU/RAS) depth value. <u>POSSIBLE VALUES:</u> 00 - Select Z 01 - Select 1/(1/W)
W_SELECT	4	0x0	Specifies source for outgoing (1/W) value, used to disable perspective correct colors/textures. <u>POSSIBLE VALUES:</u> 00 - Select (1/W) 01 - Select 1.0
FOG_STUFF_ENABLE	5	0x0	Controls enabling of fog stuffing into texture coordinate.

			POSSIBLE VALUES: 00 - Disable fog texture stuffing 01 - Enable fog texture stuffing
FOG_STUFF_TEX	9:6	0x0	Controls which texture gets fog value
FOG_STUFF_COMP	11:10	0x0	Controls which component of texture gets fog value

GB:GB_TILE_CONFIG · [R/W] · 32 bits · Access: 8/16/32 · MMRReg:0x4018			
DESCRIPTION: <i>Specifies the graphics pipeline configuration for rasterization</i>			
Field Name	Bits	Default	Description
ENABLE	0	0x1	Enables tiling, otherwise all tiles receive all polygons. POSSIBLE VALUES: 00 - Tiling disabled. 01 - Tiling enabled (def).
PIPE_COUNT	3:1	0x0	Specifies the number of active pipes and contexts (up to 4 pipes, 1 ctx). When this field is written, it is automatically reduced by hardware so as not to use more pipes than the number indicated in GB_PIPE_SELECT.MAX_PIPES or the number of pipes left unmasked GB_PIPE_SELECT.BAD_PIPES. The potentially altered value is read back, rather than the original value written by software. POSSIBLE VALUES: 00 - RV350 (1 pipe, 1 ctx) 03 - R300 (2 pipes, 1 ctx) 06 - R420-3P (3 pipes, 1 ctx) 07 - R420 (4 pipes, 1 ctx)
TILE_SIZE	5:4	0x1	Specifies width & height (square), in pixels (only 16, 32 available). POSSIBLE VALUES: 00 - 8 pixels. 01 - 16 pixels. 02 - 32 pixels.
SUPER_SIZE	8:6	0x0	Specifies number of tiles and config in super chip configuration. POSSIBLE VALUES: 00 - 1x1 tile (one 1x1). 01 - 2 tiles (two 1x1 : ST-A,B). 02 - 4 tiles (one 2x2). 03 - 8 tiles (two 2x2 : ST-A,B). 04 - 16 tiles (one 4x4). 05 - 32 tiles (two 4x4 : ST-A,B). 06 - 64 tiles (one 8x8). 07 - 128 tiles (two 8x8 : ST-A,B).

SUPER_X	11:9	0x0	X Location of chip within super tile.
SUPER_Y	14:12	0x0	Y Location of chip within super tile.
SUPER_TILE	15	0x0	Tile location of chip in a multi super tile config (Super size of 2,8,32 or 128). <u>POSSIBLE VALUES:</u> 00 - ST-A tile. 01 - ST-B tile.
SUBPIXEL	16	0x0	Specifies the precision of subpixels wrt pixels (12 or 16). <u>POSSIBLE VALUES:</u> 00 - Select 1/12 subpixel precision. 01 - Select 1/16 subpixel precision.
QUADS_PER_RAS	18:17	0x0	Specifies the number of quads to be sent to each rasterizer in turn when in RV300B or R300B mode <u>POSSIBLE VALUES:</u> 00 - 4 Quads 01 - 8 Quads 02 - 16 Quads 03 - 32 Quads
BB_SCAN	19	0x0	Specifies whether to use an intercept or bounding box based calculation for the first (coarse) scan converter <u>POSSIBLE VALUES:</u> 00 - Use intercept based scan converter 01 - Use bounding box based scan converter
ALT_SCAN_EN	20	0x0	Specifies whether to use an alternate scan pattern for the coarse scan converter <u>POSSIBLE VALUES:</u> 00 - Use normal left-right scan 01 - Use alternate left-right-left scan
ALT_OFFSET	21	0x0	Not used -- should be 0 <u>POSSIBLE VALUES:</u> 00 - Not used 01 - Not used
SUBPRECISION	22	0x0	Set to 0
ALT_TILING	23	0x0	Support for 3x2 tiling in 3P mode <u>POSSIBLE VALUES:</u> 00 - Use default tiling in all tiling modes 01 - Use alternative 3x2 tiling in 3P mode
Z_EXTENDED	24	0x0	Support for extended setup Z range from [0,1] to [-2,2] with per pixel clamping <u>POSSIBLE VALUES:</u>

			00 - Use (24.1) Z format, with vertex clamp to [1.0,0.0] 01 - Use (S25.1) format, with vertex clamp to [2.0,-2.0] and per pixel [1.0,0.0]
--	--	--	--

GB:GB_Z_PEQ_CONFIG · [R/W] · 32 bits · Access: 8/16/32 · MMReg:0x4028			
DESCRIPTION: <i>Specifies the z plane equation configuration.</i>			
Field Name	Bits	Default	Description
Z_PEQ_SIZE	0	0x0	Specifies the z plane equation size. POSSIBLE VALUES: 00 - 4x4 z plane equations (point-sampled or aa) 01 - 8x8 z plane equations (point-sampled only)

10.5 Rasterizer Registers

RS:RS_COUNT · [R/W] · 32 bits · Access: 8/16/32 · MMReg:0x4300			
DESCRIPTION: This register specifies the rasterizer input packet configuration			
Field Name	Bits	Default	Description
IT_COUNT	6:0	0x0	Specifies the total number of texture address components contained in the rasterizer input packet (0:32).
IC_COUNT	10:7	0x0	Specifies the total number of colors contained in the rasterizer input packet (0:4).
W_ADDR	17:12	0x0	Specifies the relative rasterizer input packet location of w (if w_count==1)
HIRES_EN	18	0x0	Enable high resolution texture coordinate output when q is equal to 1

RS:RS_INST_[0-15] · [R/W] · 32 bits · Access: 8/16/32 · MMReg:0x4320-0x435c			
DESCRIPTION: This table specifies what happens during each rasterizer instruction			
Field Name	Bits	Default	Description
TEX_ID	3:0	0x0	Specifies the index (into the RS_IP table) of the texture address output during this rasterizer instruction
TEX_CN	4	0x0	Write enable for texture address POSSIBLE VALUES: 00 - No write - texture coordinate not valid 01 - write - texture valid
TEX_ADDR	11:5	0x0	Specifies the destination address (within the current pixel stack frame) of the texture address output during this rasterizer instruction
COL_ID	15:12	0x0	Specifies the index (into the RS_IP table) of the color output during this rasterizer instruction
COL_CN	17:16	0x0	Write enable for color POSSIBLE VALUES: 00 - No write - color not valid 01 - write - color valid 02 - write fbuffer - XY00->RGBA 03 - write backface - B000->RGBA
COL_ADDR	24:18	0x0	Specifies the destination address (within the current pixel stack frame) of the color output during this rasterizer instruction
TEX_ADJ	25	0x0	Specifies whether to sample texture coordinates at the real or adjusted pixel centers POSSIBLE VALUES: 00 - Sample texture coordinates at real pixel centers 01 - Sample texture coordinates at adjusted pixel

			centers
W_CN	26	0x0	Specifies that the rasterizer should output w <u>POSSIBLE VALUES:</u> 00 - No write - w not valid 01 - write - w valid

RS:RS_INST_COUNT · [R/W] · 32 bits · Access: 8/16/32 · MMRReg:0x4304			
DESCRIPTION: <i>This register specifies the number of rasterizer instructions</i>			
Field Name	Bits	Default	Description
INST_COUNT	3:0	0x0	Number of rasterizer instructions (1:16)
TX_OFFSET	7:5	0x0	Indicates range of texture offset to minimize periodic errors on texels sampled right on their edges

RS:RS_IP [0-15] · [R/W] · 32 bits · Access: 8/16/32 · MMRReg:0x4074-0x40b0			
DESCRIPTION: <i>This table specifies the source location and format for up to 16 texture addresses (i[0]:i[15]) and four colors (c[0]:c[3])</i>			
Field Name	Bits	Default	Description
TEX_PTR_S	5:0	0x0	Specifies the relative rasterizer input packet location of each component (S, T, R, and Q) of texture address (i[i]). The values 62 and 63 select constant inputs for the component: 62 selects K0 (0.0), and 63 selects K1 (1.0).
TEX_PTR_T	11:6	0x0	Specifies the relative rasterizer input packet location of each component (S, T, R, and Q) of texture address (i[i]). The values 62 and 63 select constant inputs for the component: 62 selects K0 (0.0), and 63 selects K1 (1.0).
TEX_PTR_R	17:12	0x0	Specifies the relative rasterizer input packet location of each component (S, T, R, and Q) of texture address (i[i]). The values 62 and 63 select constant inputs for the component: 62 selects K0 (0.0), and 63 selects K1 (1.0).
TEX_PTR_Q	23:18	0x0	Specifies the relative rasterizer input packet location of each component (S, T, R, and Q) of texture address (i[i]). The values 62 and 63 select constant inputs for the component: 62 selects K0 (0.0), and 63 selects K1 (1.0).
COL_PTR	26:24	0x0	Specifies the relative rasterizer input packet location of the color (c[i]).
COL_FMT	30:27	0x0	Specifies the format of the color (c[i]). <u>POSSIBLE VALUES:</u> 00 - Four components (R,G,B,A) 01 - Three components (R,G,B,0) 02 - Three components (R,G,B,1) 04 - One component (0,0,0,A) 05 - Zero components (0,0,0,0) 06 - Zero components (0,0,0,1)

			<p>08 - One component (1,1,1,A) 09 - Zero components (1,1,1,0) 10 - Zero components (1,1,1,1)</p>
OFFSET_EN	31	0x0	<p>Enable application of the TX_OFFSET in RS_INST_COUNT</p> <p><u>POSSIBLE VALUES:</u> 00 - Do not apply the TX_OFFSET in RS_INST_COUNT 01 - Apply the TX_OFFSET specified by RS_INST_COUNT</p>

10.6 Clipping Registers

SC:SC_CLIP_0_A · [R/W] · 32 bits · Access: 8/16/32 · MMReg:0x43b0			
DESCRIPTION: <i>OpenGL Clip rectangles</i>			
Field Name	Bits	Default	Description
XS0	12:0	0x0	Left hand edge of clip rectangle
YS0	25:13	0x0	Upper edge of clip rectangle

SC:SC_CLIP_0_B · [R/W] · 32 bits · Access: 8/16/32 · MMReg:0x43b4			
DESCRIPTION: <i>OpenGL Clip rectangles</i>			
Field Name	Bits	Default	Description
XS1	12:0	0x0	Right hand edge of clip rectangle
YS1	25:13	0x0	Lower edge of clip rectangle

SC:SC_CLIP_1_A · [R/W] · 32 bits · Access: 8/16/32 · MMReg:0x43b8			
Field Name	Bits	Default	Description
XS0	12:0	0x0	
YS0	25:13	0x0	

SC:SC_CLIP_1_B · [R/W] · 32 bits · Access: 8/16/32 · MMReg:0x43bc			
Field Name	Bits	Default	Description
XS1	12:0	0x0	
YS1	25:13	0x0	

SC:SC_CLIP_2_A · [R/W] · 32 bits · Access: 8/16/32 · MMReg:0x43c0			
Field Name	Bits	Default	Description
XS0	12:0	0x0	
YS0	25:13	0x0	

SC:SC_CLIP_2_B · [R/W] · 32 bits · Access: 8/16/32 · MMReg:0x43c4			
Field Name	Bits	Default	Description
XS1	12:0	0x0	
YS1	25:13	0x0	

SC:SC_CLIP_3_A · [R/W] · 32 bits · Access: 8/16/32 · MMReg:0x43c8			
Field Name	Bits	Default	Description

XS0	12:0	0x0	
YS0	25:13	0x0	

SC:SC_CLIP_3_B · [R/W] · 32 bits · Access: 8/16/32 · MMReg:0x43cc			
Field Name	Bits	Default	Description
XS1	12:0	0x0	
YS1	25:13	0x0	

SC:SC_CLIP_RULE · [R/W] · 32 bits · Access: 8/16/32 · MMReg:0x43d0			
DESCRIPTION: OpenGL Clip boolean function			
Field Name	Bits	Default	Description
CLIP_RULE	15:0	0x0	OpenGL Clip boolean function. The `inside` flags for each of the four clip rectangles form a 4-bit binary number. The corresponding bit in this 16-bit number specifies whether the pixel is visible.

SC:SC_EDGERULE · [R/W] · 32 bits · Access: 8/16/32 · MMReg:0x43a8			
DESCRIPTION: Edge rules - what happens when an edge falls exactly on a sample point			
Field Name	Bits	Default	Description
ER_TRI	4:0	0x0	Edge rules for triangles, points, left-right lines, right-left lines, upper-bottom lines, bottom-upper lines. For values 0 to 15, bit 0 specifies whether a sample on a horizontal-bottom edge is in, bit 1 specifies whether a sample on a horizontal-top edge is in, bit 2 specifies whether a sample on a right edge is in, bit 3 specifies whether a sample on a left edge is in. For values 16 to 31, bit 0 specifies whether a sample on a vertical-right edge is in, bit 1 specifies whether a sample on a vertical-left edge is in, bit 2 specifies whether a sample on a bottom edge is in, bit 3 specifies whether a sample on a top edge is in POSSIBLE VALUES: 00 - L-in,R-in,HT-in,HB-in 01 - L-in,R-in,HT-in,HB-out 02 - L-in,R-in,HT-out,HB-in 03 - L-in,R-in,HT-out,HB-out 04 - L-in,R-out,HT-in,HB-in 05 - L-in,R-out,HT-in,HB-out 06 - L-in,R-out,HT-out,HB-in 07 - L-in,R-out,HT-out,HB-out 08 - L-out,R-in,HT-in,HB-in 09 - L-out,R-in,HT-in,HB-out 10 - L-out,R-in,HT-out,HB-in 11 - L-out,R-in,HT-out,HB-out 12 - L-out,R-out,HT-in,HB-in

			<p>13 - L-out,R-out,HT-in,HB-out 14 - L-out,R-out,HT-out,HB-in 15 - L-out,R-out,HT-out,HB-out 16 - T-in,B-in,VL-in,VR-in 17 - T-in,B-in,VL-in,VR-out 18 - T-in,B-in,VL,VR-in 19 - T-in,B-in,VL-out,VR-out 20 - T-out,B-in,VL-in,VR-in 21 - T-out,B-in,VL-in,VR-out 22 - T-out,B-in,VL-out,VR-in 23 - T-out,B-in,VL-out,VR-out 24 - T-in,B-out,VL-in,VR-in 25 - T-in,B-out,VL-in,VR-out 26 - T-in,B-out,VL-out,VR-in 27 - T-in,B-out,VL-out,VR-out 28 - T-out,B-out,VL-in,VR-in 29 - T-out,B-out,VL-in,VR-out 30 - T-out,B-out,VL-out,VR-in 31 - T-out,B-out,VL-out,VR-out</p>
ER_POINT	9:5	0x0	<p>Edge rules for triangles, points, left-right lines, right-left lines, upper-bottom lines, bottom-upper lines. For values 0 to 15, bit 0 specifies whether a sample on a horizontal-bottom edge is in, bit 1 specifies whether a sample on a horizontal-top edge is in, bit 2 species whether a sample on a right edge is in, bit 3 specifies whether a sample on a left edge is in. For values 16 to 31, bit 0 specifies whether a sample on a vertical-right edge is in, bit 1 specifies whether a sample on a vertical-left edge is in, bit 2 species whether a sample on a bottom edge is in, bit 3 specifies whether a sample on a top edge is in</p> <p><u>POSSIBLE VALUES:</u></p> <p>00 - L-in,R-in,HT-in,HB-in 01 - L-in,R-in,HT-in,HB-out 02 - L-in,R-in,HT-out,HB-in 03 - L-in,R-in,HT-out,HB-out 04 - L-in,R-out,HT-in,HB-in 05 - L-in,R-out,HT-in,HB-out 06 - L-in,R-out,HT-out,HB-in 07 - L-in,R-out,HT-out,HB-out 08 - L-out,R-in,HT-in,HB-in 09 - L-out,R-in,HT-in,HB-out 10 - L-out,R-in,HT-out,HB-in 11 - L-out,R-in,HT-out,HB-out 12 - L-out,R-out,HT-in,HB-in 13 - L-out,R-out,HT-in,HB-out 14 - L-out,R-out,HT-out,HB-in 15 - L-out,R-out,HT-out,HB-out 16 - T-in,B-in,VL-in,VR-in 17 - T-in,B-in,VL-in,VR-out 18 - T-in,B-in,VL,VR-in 19 - T-in,B-in,VL-out,VR-out 20 - T-out,B-in,VL-in,VR-in</p>

			21 - T-out,B-in,VL-in,VR-out 22 - T-out,B-in,VL-out,VR-in 23 - T-out,B-in,VL-out,VR-out 24 - T-in,B-out,VL-in,VR-in 25 - T-in,B-out,VL-in,VR-out 26 - T-in,B-out,VL-out,VR-in 27 - T-in,B-out,VL-out,VR-out 28 - T-out,B-out,VL-in,VR-in 29 - T-out,B-out,VL-in,VR-out 30 - T-out,B-out,VL-out,VR-in 31 - T-out,B-out,VL-out,VR-out
ER_LINE_LR	14:10	0x0	Edge rules for triangles, points, left-right lines, right-left lines, upper-bottom lines, bottom-upper lines. For values 0 to 15, bit 0 specifies whether a sample on a horizontal-bottom edge is in, bit 1 specifies whether a sample on a horizontal-top edge is in, bit 2 species whether a sample on a right edge is in, bit 3 specifies whether a sample on a left edge is in. For values 16 to 31, bit 0 specifies whether a sample on a vertical-right edge is in, bit 1 specifies whether a sample on a vertical-left edge is in, bit 2 species whether a sample on a bottom edge is in, bit 3 specifies whether a sample on a top edge is in <u>POSSIBLE VALUES:</u> 00 - L-in,R-in,HT-in,HB-in 01 - L-in,R-in,HT-in,HB-out 02 - L-in,R-in,HT-out,HB-in 03 - L-in,R-in,HT-out,HB-out 04 - L-in,R-out,HT-in,HB-in 05 - L-in,R-out,HT-in,HB-out 06 - L-in,R-out,HT-out,HB-in 07 - L-in,R-out,HT-out,HB-out 08 - L-out,R-in,HT-in,HB-in 09 - L-out,R-in,HT-in,HB-out 10 - L-out,R-in,HT-out,HB-in 11 - L-out,R-in,HT-out,HB-out 12 - L-out,R-out,HT-in,HB-in 13 - L-out,R-out,HT-in,HB-out 14 - L-out,R-out,HT-out,HB-in 15 - L-out,R-out,HT-out,HB-out 16 - T-in,B-in,VL-in,VR-in 17 - T-in,B-in,VL-in,VR-out 18 - T-in,B-in,VL,VR-in 19 - T-in,B-in,VL-out,VR-out 20 - T-out,B-in,VL-in,VR-in 21 - T-out,B-in,VL-in,VR-out 22 - T-out,B-in,VL-out,VR-in 23 - T-out,B-in,VL-out,VR-out 24 - T-in,B-out,VL-in,VR-in 25 - T-in,B-out,VL-in,VR-out 26 - T-in,B-out,VL-out,VR-in 27 - T-in,B-out,VL-out,VR-out 28 - T-out,B-out,VL-in,VR-in

			<p>29 - T-out,B-out,VL-in,VR-out 30 - T-out,B-out,VL-out,VR-in 31 - T-out,B-out,VL-out,VR-out</p>
ER_LINE_RL	19:15	0x0	<p>Edge rules for triangles, points, left-right lines, right-left lines, upper-bottom lines, bottom-upper lines. For values 0 to 15, bit 0 specifies whether a sample on a horizontal-bottom edge is in, bit 1 specifies whether a sample on a horizontal-top edge is in, bit 2 species whether a sample on a right edge is in, bit 3 specifies whether a sample on a left edge is in. For values 16 to 31, bit 0 specifies whether a sample on a vertical-right edge is in, bit 1 specifies whether a sample on a vertical-left edge is in, bit 2 species whether a sample on a bottom edge is in, bit 3 specifies whether a sample on a top edge is in</p> <p><u>POSSIBLE VALUES:</u></p> <p>00 - L-in,R-in,HT-in,HB-in 01 - L-in,R-in,HT-in,HB-out 02 - L-in,R-in,HT-out,HB-in 03 - L-in,R-in,HT-out,HB-out 04 - L-in,R-out,HT-in,HB-in 05 - L-in,R-out,HT-in,HB-out 06 - L-in,R-out,HT-out,HB-in 07 - L-in,R-out,HT-out,HB-out 08 - L-out,R-in,HT-in,HB-in 09 - L-out,R-in,HT-in,HB-out 10 - L-out,R-in,HT-out,HB-in 11 - L-out,R-in,HT-out,HB-out 12 - L-out,R-out,HT-in,HB-in 13 - L-out,R-out,HT-in,HB-out 14 - L-out,R-out,HT-out,HB-in 15 - L-out,R-out,HT-out,HB-out 16 - T-in,B-in,VL-in,VR-in 17 - T-in,B-in,VL-in,VR-out 18 - T-in,B-in,VL,VR-in 19 - T-in,B-in,VL-out,VR-out 20 - T-out,B-in,VL-in,VR-in 21 - T-out,B-in,VL-in,VR-out 22 - T-out,B-in,VL-out,VR-in 23 - T-out,B-in,VL-out,VR-out 24 - T-in,B-out,VL-in,VR-in 25 - T-in,B-out,VL-in,VR-out 26 - T-in,B-out,VL-out,VR-in 27 - T-in,B-out,VL-out,VR-out 28 - T-out,B-out,VL-in,VR-in 29 - T-out,B-out,VL-in,VR-out 30 - T-out,B-out,VL-out,VR-in 31 - T-out,B-out,VL-out,VR-out</p>
ER_LINE_TB	24:20	0x0	<p>Edge rules for triangles, points, left-right lines, right-left lines, upper-bottom lines, bottom-upper lines. For values 0 to 15, bit 0 specifies whether a sample on a horizontal-bottom edge is in, bit 1 specifies whether a sample on a</p>

			<p>horizontal-top edge is in, bit 2 specifies whether a sample on a right edge is in, bit 3 specifies whether a sample on a left edge is in. For values 16 to 31, bit 0 specifies whether a sample on a vertical-right edge is in, bit 1 specifies whether a sample on a vertical-left edge is in, bit 2 specifies whether a sample on a bottom edge is in, bit 3 specifies whether a sample on a top edge is in</p> <p><u>POSSIBLE VALUES:</u></p> <ul style="list-style-type: none"> 00 - L-in,R-in,HT-in,HB-in 01 - L-in,R-in,HT-in,HB-out 02 - L-in,R-in,HT-out,HB-in 03 - L-in,R-in,HT-out,HB-out 04 - L-in,R-out,HT-in,HB-in 05 - L-in,R-out,HT-in,HB-out 06 - L-in,R-out,HT-out,HB-in 07 - L-in,R-out,HT-out,HB-out 08 - L-out,R-in,HT-in,HB-in 09 - L-out,R-in,HT-in,HB-out 10 - L-out,R-in,HT-out,HB-in 11 - L-out,R-in,HT-out,HB-out 12 - L-out,R-out,HT-in,HB-in 13 - L-out,R-out,HT-in,HB-out 14 - L-out,R-out,HT-out,HB-in 15 - L-out,R-out,HT-out,HB-out 16 - T-in,B-in,VL-in,VR-in 17 - T-in,B-in,VL-in,VR-out 18 - T-in,B-in,VL,VR-in 19 - T-in,B-in,VL-out,VR-out 20 - T-out,B-in,VL-in,VR-in 21 - T-out,B-in,VL-in,VR-out 22 - T-out,B-in,VL-out,VR-in 23 - T-out,B-in,VL-out,VR-out 24 - T-in,B-out,VL-in,VR-in 25 - T-in,B-out,VL-in,VR-out 26 - T-in,B-out,VL-out,VR-in 27 - T-in,B-out,VL-out,VR-out 28 - T-out,B-out,VL-in,VR-in 29 - T-out,B-out,VL-in,VR-out 30 - T-out,B-out,VL-out,VR-in 31 - T-out,B-out,VL-out,VR-out
ER_LINE_BT	29:25	0x0	<p>Edge rules for triangles, points, left-right lines, right-left lines, upper-bottom lines, bottom-upper lines. For values 0 to 15, bit 0 specifies whether a sample on a horizontal-bottom edge is in, bit 1 specifies whether a sample on a horizontal-top edge is in, bit 2 specifies whether a sample on a right edge is in, bit 3 specifies whether a sample on a left edge is in. For values 16 to 31, bit 0 specifies whether a sample on a vertical-right edge is in, bit 1 specifies whether a sample on a vertical-left edge is in, bit 2 specifies whether a sample on a bottom edge is in, bit 3 specifies whether a sample on a top edge is in</p>

			<p><u>POSSIBLE VALUES:</u></p> <p>00 - L-in,R-in,HT-in,HB-in 01 - L-in,R-in,HT-in,HB-out 02 - L-in,R-in,HT-out,HB-in 03 - L-in,R-in,HT-out,HB-out 04 - L-in,R-out,HT-in,HB-in 05 - L-in,R-out,HT-in,HB-out 06 - L-in,R-out,HT-out,HB-in 07 - L-in,R-out,HT-out,HB-out 08 - L-out,R-in,HT-in,HB-in 09 - L-out,R-in,HT-in,HB-out 10 - L-out,R-in,HT-out,HB-in 11 - L-out,R-in,HT-out,HB-out 12 - L-out,R-out,HT-in,HB-in 13 - L-out,R-out,HT-in,HB-out 14 - L-out,R-out,HT-out,HB-in 15 - L-out,R-out,HT-out,HB-out 16 - T-in,B-in,VL-in,VR-in 17 - T-in,B-in,VL-in,VR-out 18 - T-in,B-in,VL,VR-in 19 - T-in,B-in,VL-out,VR-out 20 - T-out,B-in,VL-in,VR-in 21 - T-out,B-in,VL-in,VR-out 22 - T-out,B-in,VL-out,VR-in 23 - T-out,B-in,VL-out,VR-out 24 - T-in,B-out,VL-in,VR-in 25 - T-in,B-out,VL-in,VR-out 26 - T-in,B-out,VL-out,VR-in 27 - T-in,B-out,VL-out,VR-out 28 - T-out,B-out,VL-in,VR-in 29 - T-out,B-out,VL-in,VR-out 30 - T-out,B-out,VL-out,VR-in 31 - T-out,B-out,VL-out,VR-out</p>
--	--	--	--

SC:SC_HYPERZ_EN · [R/W] · 32 bits · Access: 8/16/32 · MMReg:0x43a4			
DESCRIPTION: Hierarchical Z Enable			
Field Name	Bits	Default	Description
HZ_EN	0	0x0	Enable for hierarchical Z. <u>POSSIBLE VALUES:</u> 00 - Disables Hyper-Z. 01 - Enables Hyper-Z.
HZ_MAX	1	0x0	Specifies whether to compute min or max z value <u>POSSIBLE VALUES:</u> 00 - HZ block computes minimum z value 01 - HZ block computes maximum z value
HZ_ADJ	4:2	0x0	Specifies adjustment to get added or subtracted from

			<p>computed z value</p> <p>POSSIBLE VALUES:</p> <ul style="list-style-type: none"> 00 - Add or Subtract 1/256 << ze 01 - Add or Subtract 1/128 << ze 02 - Add or Subtract 1/64 << ze 03 - Add or Subtract 1/32 << ze 04 - Add or Subtract 1/16 << ze 05 - Add or Subtract 1/8 << ze 06 - Add or Subtract 1/4 << ze 07 - Add or Subtract 1/2 << ze
HZ_ZOMIN	5	0x0	<p>Specifies whether vertex 0 z contains minimum z value</p> <p>POSSIBLE VALUES:</p> <ul style="list-style-type: none"> 00 - Vertex 0 does not contain minimum z value 01 - Vertex 0 does contain minimum z value
HZ_ZOMAX	6	0x0	<p>Specifies whether vertex 0 z contains maximum z value</p> <p>POSSIBLE VALUES:</p> <ul style="list-style-type: none"> 00 - Vertex 0 does not contain maximum z value 01 - Vertex 0 does contain maximum z value

SC:SC_SCISSOR0 · [R/W] · 32 bits · Access: 8/16/32 · MMReg:0x43e0			
DESCRIPTION: <i>Scissor rectangle specification</i>			
Field Name	Bits	Default	Description
XS0	12:0	0x0	Left hand edge of scissor rectangle
YS0	25:13	0x0	Upper edge of scissor rectangle

SC:SC_SCISSOR1 · [R/W] · 32 bits · Access: 8/16/32 · MMReg:0x43e4			
DESCRIPTION: <i>Scissor rectangle specification</i>			
Field Name	Bits	Default	Description
XS1	12:0	0x0	Right hand edge of scissor rectangle
YS1	25:13	0x0	Lower edge of scissor rectangle

SC:SC_SCREENDOOR · [R/W] · 32 bits · Access: 8/16/32 · MMReg:0x43e8			
DESCRIPTION: <i>Screen door sample mask</i>			
Field Name	Bits	Default	Description
SCREENDOOR	23:0	0x0	Screen door sample mask - 1 means sample may be covered, 0 means sample is not covered

10.7 Setup Unit Registers

SU:SU_CULL_MODE · [R/W] · 32 bits · Access: 8/16/32 · MMReg:0x42b8			
DESCRIPTION: <i>Culling Enables</i>			
Field Name	Bits	Default	Description
CULL_FRONT	0	0x0	Enable for front-face culling. POSSIBLE VALUES: 00 - Do not cull front-facing triangles. 01 - Cull front-facing triangles.
CULL_BACK	1	0x0	Enable for back-face culling. POSSIBLE VALUES: 00 - Do not cull back-facing triangles. 01 - Cull back-facing triangles.
FACE	2	0x0	X-Ored with cross product sign to determine positive facing POSSIBLE VALUES: 00 - Positive cross product is front (CCW). 01 - Negative cross product is front (CW).

SU:SU_DEPTH_OFFSET · [R/W] · 32 bits · Access: 8/16/32 · MMReg:0x42c4			
DESCRIPTION: <i>SU Depth Offset value</i>			
Field Name	Bits	Default	Description
OFFSET	31:0	0x0	SPFP Floating point applied to depth before conversion to FXP.

SU:SU_DEPTH_SCALE · [R/W] · 32 bits · Access: 8/16/32 · MMReg:0x42c0			
DESCRIPTION: <i>SU Depth Scale value</i>			
Field Name	Bits	Default	Description
SCALE	31:0	0x3F800000	SPFP Floating point applied to depth before conversion to FXP.

SU:SU_POLY_OFFSET_BACK_OFFSET · [R/W] · 32 bits · Access: 8/16/32 · MMReg:0x42b0			
DESCRIPTION: <i>Back-Facing Polygon Offset Offset</i>			
Field Name	Bits	Default	Description
OFFSET	31:0	0x0	Specifies polygon offset offset for back-facing polygons; 32b IEEE float format; applied after Z scale & offset (0 to 2 ²⁴ -1 range)

SU:SU_POLY_OFFSET_BACK_SCALE · [R/W] · 32 bits · Access: 8/16/32 · MMReg:0x42ac			
DESCRIPTION: <i>Back-Facing Polygon Offset Scale</i>			
Field Name	Bits	Default	Description
SCALE	31:0	0x0	Specifies polygon offset scale for back-facing polygons; 32-bit IEEE float format; applied after Z scale & offset (0 to 2 ²⁴ -1 range); slope computed in subpixels (1/12 or 1/16)

SU:SU_POLY_OFFSET_ENABLE · [R/W] · 32 bits · Access: 8/16/32 · MMReg:0x42b4			
DESCRIPTION: <i>Enables for polygon offset</i>			
Field Name	Bits	Default	Description
FRONT_ENABLE	0	0x0	Enables front facing polygon`s offset. <u>POSSIBLE VALUES:</u> 00 - Disable front offset. 01 - Enable front offset.
BACK_ENABLE	1	0x0	Enables back facing polygon`s offset. <u>POSSIBLE VALUES:</u> 00 - Disable back offset. 01 - Enable back offset.
PARA_ENABLE	2	0x0	Forces all parallelograms to have FRONT_FACING for poly offset -- Need to have FRONT_ENABLE also set to have Z offset for parallelograms. <u>POSSIBLE VALUES:</u> 00 - Disable front offset for parallelograms. 01 - Enable front offset for parallelograms.

SU:SU_POLY_OFFSET_FRONT_OFFSET · [R/W] · 32 bits · Access: 8/16/32 · MMReg:0x42a8			
DESCRIPTION: <i>Front-Facing Polygon Offset Offset</i>			
Field Name	Bits	Default	Description
OFFSET	31:0	0x0	Specifies polygon offset offset for front-facing polygons; 32b IEEE float format; applied after Z scale & offset (0 to 2 ²⁴ -1 range)

SU:SU_POLY_OFFSET_FRONT_SCALE · [R/W] · 32 bits · Access: 8/16/32 · MMReg:0x42a4			
DESCRIPTION: <i>Front-Facing Polygon Offset Scale</i>			
Field Name	Bits	Default	Description
SCALE	31:0	0x0	Specifies polygon offset scale for front-facing polygons; 32b IEEE float format; applied after Z scale & offset (0 to 2 ²⁴ -1 range); slope computed in subpixels (1/12 or 1/16)

SU:SU_REG_DEST · [R/W] · 32 bits · Access: 8/16/32 · MMReg:0x42c8			
DESCRIPTION: <i>SU Raster pipe destination select for registers</i>			
Field Name	Bits	Default	Description
SELECT	3:0	0xF	Register read/write destination select: b0: logical pipe0, b1: logical pipe1, b2: logical pipe2 and b3: logical pipe3

SU:SU_TEX_WRAP · [R/W] · 32 bits · Access: 8/16/32 · MMReg:0x42a0			
DESCRIPTION: <i>Enables for Cylindrical Wrapping</i>			
Field Name	Bits	Default	Description
T0C0	0	0x0	tNcM -- Enable texture wrapping on component M (S,T,R,Q) of texture N. <u>POSSIBLE VALUES:</u> 00 - Disable cylindrical wrapping. 01 - Enable cylindrical wrapping.
T0C1	1	0x0	tNcM -- Enable texture wrapping on component M (S,T,R,Q) of texture N. <u>POSSIBLE VALUES:</u> 00 - Disable cylindrical wrapping. 01 - Enable cylindrical wrapping.
T0C2	2	0x0	tNcM -- Enable texture wrapping on component M (S,T,R,Q) of texture N. <u>POSSIBLE VALUES:</u> 00 - Disable cylindrical wrapping. 01 - Enable cylindrical wrapping.
T0C3	3	0x0	tNcM -- Enable texture wrapping on component M (S,T,R,Q) of texture N. <u>POSSIBLE VALUES:</u> 00 - Disable cylindrical wrapping. 01 - Enable cylindrical wrapping.
T1C0	4	0x0	tNcM -- Enable texture wrapping on component M (S,T,R,Q) of texture N. <u>POSSIBLE VALUES:</u> 00 - Disable cylindrical wrapping. 01 - Enable cylindrical wrapping.
T1C1	5	0x0	tNcM -- Enable texture wrapping on component M (S,T,R,Q) of texture N. <u>POSSIBLE VALUES:</u> 00 - Disable cylindrical wrapping.

			01 - Enable cylindrical wrapping.
T1C2	6	0x0	tNcM -- Enable texture wrapping on component M (S,T,R,Q) of texture N. <u>POSSIBLE VALUES:</u> 00 - Disable cylindrical wrapping. 01 - Enable cylindrical wrapping.
T1C3	7	0x0	tNcM -- Enable texture wrapping on component M (S,T,R,Q) of texture N. <u>POSSIBLE VALUES:</u> 00 - Disable cylindrical wrapping. 01 - Enable cylindrical wrapping.
T2C0	8	0x0	tNcM -- Enable texture wrapping on component M (S,T,R,Q) of texture N. <u>POSSIBLE VALUES:</u> 00 - Disable cylindrical wrapping. 01 - Enable cylindrical wrapping.
T2C1	9	0x0	tNcM -- Enable texture wrapping on component M (S,T,R,Q) of texture N. <u>POSSIBLE VALUES:</u> 00 - Disable cylindrical wrapping. 01 - Enable cylindrical wrapping.
T2C2	10	0x0	tNcM -- Enable texture wrapping on component M (S,T,R,Q) of texture N. <u>POSSIBLE VALUES:</u> 00 - Disable cylindrical wrapping. 01 - Enable cylindrical wrapping.
T2C3	11	0x0	tNcM -- Enable texture wrapping on component M (S,T,R,Q) of texture N. <u>POSSIBLE VALUES:</u> 00 - Disable cylindrical wrapping. 01 - Enable cylindrical wrapping.
T3C0	12	0x0	tNcM -- Enable texture wrapping on component M (S,T,R,Q) of texture N. <u>POSSIBLE VALUES:</u> 00 - Disable cylindrical wrapping. 01 - Enable cylindrical wrapping.
T3C1	13	0x0	tNcM -- Enable texture wrapping on component M (S,T,R,Q) of texture N. <u>POSSIBLE VALUES:</u> 00 - Disable cylindrical wrapping. 01 - Enable cylindrical wrapping.

T3C2	14	0x0	tNcM -- Enable texture wrapping on component M (S,T,R,Q) of texture N. <u>POSSIBLE VALUES:</u> 00 - Disable cylindrical wrapping. 01 - Enable cylindrical wrapping.
T3C3	15	0x0	tNcM -- Enable texture wrapping on component M (S,T,R,Q) of texture N. <u>POSSIBLE VALUES:</u> 00 - Disable cylindrical wrapping. 01 - Enable cylindrical wrapping.
T4C0	16	0x0	tNcM -- Enable texture wrapping on component M (S,T,R,Q) of texture N. <u>POSSIBLE VALUES:</u> 00 - Disable cylindrical wrapping. 01 - Enable cylindrical wrapping.
T4C1	17	0x0	tNcM -- Enable texture wrapping on component M (S,T,R,Q) of texture N. <u>POSSIBLE VALUES:</u> 00 - Disable cylindrical wrapping. 01 - Enable cylindrical wrapping.
T4C2	18	0x0	tNcM -- Enable texture wrapping on component M (S,T,R,Q) of texture N. <u>POSSIBLE VALUES:</u> 00 - Disable cylindrical wrapping. 01 - Enable cylindrical wrapping.
T4C3	19	0x0	tNcM -- Enable texture wrapping on component M (S,T,R,Q) of texture N. <u>POSSIBLE VALUES:</u> 00 - Disable cylindrical wrapping. 01 - Enable cylindrical wrapping.
T5C0	20	0x0	tNcM -- Enable texture wrapping on component M (S,T,R,Q) of texture N. <u>POSSIBLE VALUES:</u> 00 - Disable cylindrical wrapping. 01 - Enable cylindrical wrapping.
T5C1	21	0x0	tNcM -- Enable texture wrapping on component M (S,T,R,Q) of texture N. <u>POSSIBLE VALUES:</u> 00 - Disable cylindrical wrapping. 01 - Enable cylindrical wrapping.
T5C2	22	0x0	tNcM -- Enable texture wrapping on component M

			(S,T,R,Q) of texture N. <u>POSSIBLE VALUES:</u> 00 - Disable cylindrical wrapping. 01 - Enable cylindrical wrapping.
T5C3	23	0x0	tNcM -- Enable texture wrapping on component M (S,T,R,Q) of texture N. <u>POSSIBLE VALUES:</u> 00 - Disable cylindrical wrapping. 01 - Enable cylindrical wrapping.
T6C0	24	0x0	tNcM -- Enable texture wrapping on component M (S,T,R,Q) of texture N. <u>POSSIBLE VALUES:</u> 00 - Disable cylindrical wrapping. 01 - Enable cylindrical wrapping.
T6C1	25	0x0	tNcM -- Enable texture wrapping on component M (S,T,R,Q) of texture N. <u>POSSIBLE VALUES:</u> 00 - Disable cylindrical wrapping. 01 - Enable cylindrical wrapping.
T6C2	26	0x0	tNcM -- Enable texture wrapping on component M (S,T,R,Q) of texture N. <u>POSSIBLE VALUES:</u> 00 - Disable cylindrical wrapping. 01 - Enable cylindrical wrapping.
T6C3	27	0x0	tNcM -- Enable texture wrapping on component M (S,T,R,Q) of texture N. <u>POSSIBLE VALUES:</u> 00 - Disable cylindrical wrapping. 01 - Enable cylindrical wrapping.
T7C0	28	0x0	tNcM -- Enable texture wrapping on component M (S,T,R,Q) of texture N. <u>POSSIBLE VALUES:</u> 00 - Disable cylindrical wrapping. 01 - Enable cylindrical wrapping.
T7C1	29	0x0	tNcM -- Enable texture wrapping on component M (S,T,R,Q) of texture N. <u>POSSIBLE VALUES:</u> 00 - Disable cylindrical wrapping. 01 - Enable cylindrical wrapping.
T7C2	30	0x0	tNcM -- Enable texture wrapping on component M (S,T,R,Q) of texture N.

			<p><u>POSSIBLE VALUES:</u> 00 - Disable cylindrical wrapping. 01 - Enable cylindrical wrapping.</p>
T7C3	31	0x0	<p>tNcM -- Enable texture wrapping on component M (S,T,R,Q) of texture N.</p> <p><u>POSSIBLE VALUES:</u> 00 - Disable cylindrical wrapping. 01 - Enable cylindrical wrapping.</p>

SU:SU_TEX_WRAP_PS3 · [R/W] · 32 bits · Access: 8/16/32 · MMReg:0x4114			
DESCRIPTION: Specifies texture wrapping for new PS3 textures.			
Field Name	Bits	Default	Description
T9C0	0	0x0	<p>tNcM -- Enable texture wrapping on component M (S,T,R,Q) of texture N.</p> <p><u>POSSIBLE VALUES:</u> 00 - Disable cylindrical wrapping. 01 - Enable cylindrical wrapping.</p>
T9C1	1	0x0	<p>tNcM -- Enable texture wrapping on component M (S,T,R,Q) of texture N.</p> <p><u>POSSIBLE VALUES:</u> 00 - Disable cylindrical wrapping. 01 - Enable cylindrical wrapping.</p>
T9C2	2	0x0	<p>tNcM -- Enable texture wrapping on component M (S,T,R,Q) of texture N.</p> <p><u>POSSIBLE VALUES:</u> 00 - Disable cylindrical wrapping. 01 - Enable cylindrical wrapping.</p>
T9C3	3	0x0	<p>tNcM -- Enable texture wrapping on component M (S,T,R,Q) of texture N.</p> <p><u>POSSIBLE VALUES:</u> 00 - Disable cylindrical wrapping. 01 - Enable cylindrical wrapping.</p>
T8C0	4	0x0	<p>tNcM -- Enable texture wrapping on component M (S,T,R,Q) of texture N.</p> <p><u>POSSIBLE VALUES:</u> 00 - Disable cylindrical wrapping. 01 - Enable cylindrical wrapping.</p>
T8C1	5	0x0	<p>tNcM -- Enable texture wrapping on component M (S,T,R,Q) of texture N.</p>

			<p><u>POSSIBLE VALUES:</u> 00 - Disable cylindrical wrapping. 01 - Enable cylindrical wrapping.</p>
T8C2	6	0x0	<p>tNcM -- Enable texture wrapping on component M (S,T,R,Q) of texture N.</p> <p><u>POSSIBLE VALUES:</u> 00 - Disable cylindrical wrapping. 01 - Enable cylindrical wrapping.</p>
T8C3	7	0x0	<p>tNcM -- Enable texture wrapping on component M (S,T,R,Q) of texture N.</p> <p><u>POSSIBLE VALUES:</u> 00 - Disable cylindrical wrapping. 01 - Enable cylindrical wrapping.</p>

10.8 Texture Registers

TX:TX_BORDER_COLOR [0-15] · [R/W] · 32 bits · Access: 8/16/32 · MMReg:0x45c0-0x45fc			
DESCRIPTION: <i>Border Color</i>			
Field Name	Bits	Default	Description
BORDER_COLOR	31:0	none	Color used for borders. Format is the same as the texture being bordered.

TX:TX_CHROMA_KEY [0-15] · [R/W] · 32 bits · Access: 8/16/32 · MMReg:0x4580-0x45bc			
DESCRIPTION: <i>Texture Chroma Key</i>			
Field Name	Bits	Default	Description
CHROMA_KEY	31:0	none	Color used for chroma key compare. Format is the same as the texture being keyed.

TX:TX_ENABLE · [R/W] · 32 bits · Access: 8/16/32 · MMReg:0x4104			
DESCRIPTION: <i>Texture Enables for Maps 0 to 15</i>			
Field Name	Bits	Default	Description
TEX_0_ENABLE	0	none	Texture Map Enables. <u>POSSIBLE VALUES:</u> 00 - Disable, ARGB = 1,0,0,0 01 - Enable
TEX_1_ENABLE	1	none	Texture Map Enables. <u>POSSIBLE VALUES:</u> 00 - Disable, ARGB = 1,0,0,0 01 - Enable
TEX_2_ENABLE	2	none	Texture Map Enables. <u>POSSIBLE VALUES:</u> 00 - Disable, ARGB = 1,0,0,0 01 - Enable
TEX_3_ENABLE	3	none	Texture Map Enables. <u>POSSIBLE VALUES:</u> 00 - Disable, ARGB = 1,0,0,0 01 - Enable
TEX_4_ENABLE	4	none	Texture Map Enables. <u>POSSIBLE VALUES:</u> 00 - Disable, ARGB = 1,0,0,0 01 - Enable
TEX_5_ENABLE	5	none	Texture Map Enables.

			<u>POSSIBLE VALUES:</u> 00 - Disable, ARGB = 1,0,0,0 01 - Enable
TEX_6_ENABLE	6	none	Texture Map Enables. <u>POSSIBLE VALUES:</u> 00 - Disable, ARGB = 1,0,0,0 01 - Enable
TEX_7_ENABLE	7	none	Texture Map Enables. <u>POSSIBLE VALUES:</u> 00 - Disable, ARGB = 1,0,0,0 01 - Enable
TEX_8_ENABLE	8	none	Texture Map Enables. <u>POSSIBLE VALUES:</u> 00 - Disable, ARGB = 1,0,0,0 01 - Enable
TEX_9_ENABLE	9	none	Texture Map Enables. <u>POSSIBLE VALUES:</u> 00 - Disable, ARGB = 1,0,0,0 01 - Enable
TEX_10_ENABLE	10	none	Texture Map Enables. <u>POSSIBLE VALUES:</u> 00 - Disable, ARGB = 1,0,0,0 01 - Enable
TEX_11_ENABLE	11	none	Texture Map Enables. <u>POSSIBLE VALUES:</u> 00 - Disable, ARGB = 1,0,0,0 01 - Enable
TEX_12_ENABLE	12	none	Texture Map Enables. <u>POSSIBLE VALUES:</u> 00 - Disable, ARGB = 1,0,0,0 01 - Enable
TEX_13_ENABLE	13	none	Texture Map Enables. <u>POSSIBLE VALUES:</u> 00 - Disable, ARGB = 1,0,0,0 01 - Enable
TEX_14_ENABLE	14	none	Texture Map Enables. <u>POSSIBLE VALUES:</u> 00 - Disable, ARGB = 1,0,0,0

			01 - Enable
TEX_15_ENABLE	15	none	Texture Map Enables. <u>POSSIBLE VALUES:</u> 00 - Disable, ARGB = 1,0,0,0 01 - Enable

TX:TX_FILTER0 [0-15] · [R/W] · 32 bits · Access: 8/16/32 · MMReg:0x4400-0x443c			
DESCRIPTION: <i>Texture Filter State</i>			
Field Name	Bits	Default	Description
CLAMP_S	2:0	none	Clamp mode for texture coordinates <u>POSSIBLE VALUES:</u> 00 - Wrap (repeat) 01 - Mirror 02 - Clamp to last texel (0.0 to 1.0) 03 - MirrorOnce to last texel (-1.0 to 1.0) 04 - Clamp half way to border color (0.0 to 1.0) 05 - MirrorOnce half way to border color (-1.0 to 1.0) 06 - Clamp to border color (0.0 to 1.0) 07 - MirrorOnce to border color (-1.0 to 1.0)
CLAMP_T	5:3	none	Clamp mode for texture coordinates <u>POSSIBLE VALUES:</u> 00 - Wrap (repeat) 01 - Mirror 02 - Clamp to last texel (0.0 to 1.0) 03 - MirrorOnce to last texel (-1.0 to 1.0) 04 - Clamp half way to border color (0.0 to 1.0) 05 - MirrorOnce half way to border color (-1.0 to 1.0) 06 - Clamp to border color (0.0 to 1.0) 07 - MirrorOnce to border color (-1.0 to 1.0)
CLAMP_R	8:6	none	Clamp mode for texture coordinates <u>POSSIBLE VALUES:</u> 00 - Wrap (repeat) 01 - Mirror 02 - Clamp to last texel (0.0 to 1.0) 03 - MirrorOnce to last texel (-1.0 to 1.0) 04 - Clamp half way to border color (0.0 to 1.0) 05 - MirrorOnce half way to border color (-1.0 to 1.0) 06 - Clamp to border color (0.0 to 1.0) 07 - MirrorOnce to border color (-1.0 to 1.0)
MAG_FILTER	10:9	none	Filter used when texture is magnified <u>POSSIBLE VALUES:</u> 00 - Filter4 01 - Point

			02 - Linear 03 - Reserved
MIN_FILTER	12:11	none	Filter used when texture is minified <u>POSSIBLE VALUES:</u> 00 - Filter4 01 - Point 02 - Linear 03 - Reserved
MIP_FILTER	14:13	none	Filter used between mipmap levels <u>POSSIBLE VALUES:</u> 00 - None 01 - Point 02 - Linear 03 - Reserved
VOL_FILTER	16:15	none	Filter used between layers of a volume <u>POSSIBLE VALUES:</u> 00 - None (no filter specified, select from MIN/MAG filters) 01 - Point 02 - Linear 03 - Reserved
MAX_MIP_LEVEL	20:17	none	LOD index of largest (finest) mipmap to use (0 is largest). Ranges from 0 to NUM_LEVELS.
Reserved	23:21	none	
ID	31:28	none	Logical id for this physical texture

TX:TX_FILTER1 [0-15] · [R/W] · 32 bits · Access: 8/16/32 · MMReg:0x4440-0x447c			
DESCRIPTION: <i>Texture Filter State</i>			
Field Name	Bits	Default	Description
CHROMA_KEY_MODE	1:0	none	Chroma Key Mode <u>POSSIBLE VALUES:</u> 00 - Disable 01 - ChromaKey (kill pixel if any sample matches chroma key) 02 - ChromaKeyBlend (set sample to 0 if it matches chroma key)
MC_ROUND	2	none	Bilinear rounding mode <u>POSSIBLE VALUES:</u> 00 - Normal rounding on all components (+0.5) 01 - MPEG4 rounding on all components (+0.25)
LOD_BIAS	12:3	none	(s4.5). Ranges from -16.0 to 15.99. Mipmap LOD bias measured in mipmap levels. Added to the signed,

			computed LOD before the LOD is clamped.
Reserved	13	none	
MC_COORD_TRUNCATE	14	none	MPEG coordinate truncation mode <u>POSSIBLE VALUES:</u> 00 - Dont truncate coordinate fractions. 01 - Truncate coordinate fractions to 0.0 and 0.5 for MPEG
TRI_PERF	16:15	none	Apply slope and bias to trilerp fraction to reduce the number of 2-level fetches for trilinear. Should only be used if MIP_FILTER is LINEAR. <u>POSSIBLE VALUES:</u> 00 - Breakpoint=0/8. lfrac_out = lfrac_in 01 - Breakpoint=1/8. lfrac_out = clamp(4/3*lfrac_in - 1/6) 02 - Breakpoint=1/4. lfrac_out = clamp(2*lfrac_in - 1/2) 03 - Breakpoint=3/8. lfrac_out = clamp(4*lfrac_in - 3/2)
Reserved	19:17	none	Set to 0
Reserved	20	none	Set to 0
Reserved	21	none	Set to 0
MACRO_SWITCH	22	none	If enabled, addressing switches to macro-linear when image width is <= 8 micro-tiles. If disabled, functionality is same as RV350, switch to macro-linear when image width is < 8 micro-tiles. <u>POSSIBLE VALUES:</u> 00 - RV350 mode 01 - Switch from macro-tiled to macro-linear when (width <= 8 micro-tiles)
Reserved	28:23	none	
Reserved	29	none	
Reserved	30	none	
BORDER_FIX	31	none	To fix issues when using non-square mipmaps, with border_color, and extreme minification. <u>POSSIBLE VALUES:</u> 00 - R3xx R4xx mode 01 - Stop right shifting coord once mip size is pinned to one

TX:TX_FILTER4 · [R/W] · 32 bits · Access: 8/16/32 · MMReg:0x4110			
DESCRIPTION: <i>Filter4 Kernel</i>			
Field Name	Bits	Default	Description

WEIGHT_1	10:0	none	(s1.9). Bottom or Right weight of pair.
WEIGHT_0	21:11	none	(s1.9). Top or Left weight of pair.
WEIGHT_PAIR	22	none	Indicates which pair of weights within phase to load. <u>POSSIBLE VALUES:</u> 00 - Top or Left 01 - Bottom or Right
PHASE	26:23	none	Indicates which of 9 phases to load
DIRECTION	27	none	Indicates whether to load the horizontal or vertical weights <u>POSSIBLE VALUES:</u> 00 - Horizontal 01 - Vertical

TX:TX_FORMAT0 [0-15] · [R/W] · 32 bits · Access: 8/16/32 · MMReg:0x4480-0x44bc			
DESCRIPTION: <i>Texture Format State</i>			
Field Name	Bits	Default	Description
TXWIDTH	10:0	none	Image width - 1. The largest image is 4096 texels. When wrapping or mirroring, must be a power of 2. When mipmapping, must be a power of 2 or padded to a power of 2 in memory. Can always be non-square, except for cube maps which must be square.
TXHEIGHT	21:11	none	Image height - 1. The largest image is 4096 texels. When wrapping or mirroring, must be a power of 2. When mipmapping, must be a power of 2 or padded to a power of 2 in memory. Can always be non-square, except for cube maps which must be square.
TXDEPTH	25:22	none	LOG2(depth) of volume texture
NUM_LEVELS	29:26	none	Number of mipmap levels minus 1. Ranges from 0 to 12. Equivalent to LOD index of smallest (coarsest) mipmap to use.
PROJECTED	30	none	Specifies whether texture coords are projected. <u>POSSIBLE VALUES:</u> 00 - Non-Projected 01 - Projected
TXPITCH_EN	31	none	Indicates when TXPITCH should be used instead of TXWIDTH for image addressing <u>POSSIBLE VALUES:</u> 00 - Use TXWIDTH for image addressing 01 - Use TXPITCH for image addressing

TX:TX_FORMAT1 [0-15] · [R/W] · 32 bits · Access: 8/16/32 · MMReg:0x44c0-0x44fc			
--	--	--	--

DESCRIPTION: <i>Texture Format State</i>			
Field Name	Bits	Default	Description
TXFORMAT	4:0	none	Texture Format. Components are numbered right to left. Parenthesis indicate typical uses of each format. <u>POSSIBLE VALUES:</u> 00 - TX_FMT_8 or TX_FMT_1 (if TX_FORMAT2.TXFORMAT_MSB is set) 01 - TX_FMT_16 or TX_FMT_1_REVERSE (if TX_FORMAT2.TXFORMAT_MSB is set) 02 - TX_FMT_4_4 or TX_FMT_10 (if TX_FORMAT2.TXFORMAT_MSB is set) 03 - TX_FMT_8_8 or TX_FMT_10_10 (if TX_FORMAT2.TXFORMAT_MSB is set) 04 - TX_FMT_16_16 or TX_FMT_10_10_10_10 (if TX_FORMAT2.TXFORMAT_MSB is set) 05 - TX_FMT_3_3_2 or TX_FMT_ATI1N (if TX_FORMAT2.TXFORMAT_MSB is set) 06 - TX_FMT_5_6_5 07 - TX_FMT_6_5_5 08 - TX_FMT_11_11_10 09 - TX_FMT_10_11_11 10 - TX_FMT_4_4_4_4 11 - TX_FMT_1_5_5_5 12 - TX_FMT_8_8_8_8 13 - TX_FMT_2_10_10_10 14 - TX_FMT_16_16_16_16 15 - Reserved 16 - Reserved 17 - Reserved 18 - TX_FMT_Y8 19 - TX_FMT_AVYU444 20 - TX_FMT_VYUY422 21 - TX_FMT_YVYU422 22 - TX_FMT_16_MPEG 23 - TX_FMT_16_16_MPEG 24 - TX_FMT_16f 25 - TX_FMT_16f_16f 26 - TX_FMT_16f_16f_16f_16f 27 - TX_FMT_32f 28 - TX_FMT_32f_32f 29 - TX_FMT_32f_32f_32f_32f 30 - TX_FMT_W24_FP 31 - TX_FMT_ATI2N
SIGNED_COMP0	5	none	Component filter should interpret texel data as signed or unsigned. (Ignored for Y/YUV formats.) <u>POSSIBLE VALUES:</u> 00 - Component filter should interpret texel data as unsigned 01 - Component filter should interpret texel data as signed

SIGNED_COMP1	6	none	Component filter should interpret texel data as signed or unsigned. (Ignored for Y/YUV formats.) <u>POSSIBLE VALUES:</u> 00 - Component filter should interpret texel data as unsigned 01 - Component filter should interpret texel data as signed
SIGNED_COMP2	7	none	Component filter should interpret texel data as signed or unsigned. (Ignored for Y/YUV formats.) <u>POSSIBLE VALUES:</u> 00 - Component filter should interpret texel data as unsigned 01 - Component filter should interpret texel data as signed
SIGNED_COMP3	8	none	Component filter should interpret texel data as signed or unsigned. (Ignored for Y/YUV formats.) <u>POSSIBLE VALUES:</u> 00 - Component filter should interpret texel data as unsigned 01 - Component filter should interpret texel data as signed
SEL_ALPHA	11:9	none	Specifies swizzling for each channel at the input of the pixel shader. (Ignored for Y/YUV formats.) <u>POSSIBLE VALUES:</u> 00 - Select Texture Component0. 01 - Select Texture Component1. 02 - Select Texture Component2. 03 - Select Texture Component3. 04 - Select the value 0. 05 - Select the value 1.
SEL_RED	14:12	none	Specifies swizzling for each channel at the input of the pixel shader. (Ignored for Y/YUV formats.) <u>POSSIBLE VALUES:</u> 00 - Select Texture Component0. 01 - Select Texture Component1. 02 - Select Texture Component2. 03 - Select Texture Component3. 04 - Select the value 0. 05 - Select the value 1.
SEL_GREEN	17:15	none	Specifies swizzling for each channel at the input of the pixel shader. (Ignored for Y/YUV formats.) <u>POSSIBLE VALUES:</u> 00 - Select Texture Component0. 01 - Select Texture Component1.

			02 - Select Texture Component2. 03 - Select Texture Component3. 04 - Select the value 0. 05 - Select the value 1.
SEL_BLUE	20:18	none	Specifies swizzling for each channel at the input of the pixel shader. (Ignored for Y/YUV formats.) <u>POSSIBLE VALUES:</u> 00 - Select Texture Component0. 01 - Select Texture Component1. 02 - Select Texture Component2. 03 - Select Texture Component3. 04 - Select the value 0. 05 - Select the value 1.
GAMMA	21	none	Optionally remove gamma from texture before passing to shader. Only apply to 8bit or less components. <u>POSSIBLE VALUES:</u> 00 - Disable gamma removal 01 - Enable gamma removal
YUV_TO_RGB	23:22	none	YUV to RGB conversion mode <u>POSSIBLE VALUES:</u> 00 - Disable YUV to RGB conversion 01 - Enable YUV to RGB conversion (with clamp) 02 - Enable YUV to RGB conversion (without clamp)
SWAP_YUV	24	none	<u>POSSIBLE VALUES:</u> 00 - Disable swap YUV mode 01 - Enable swap YUV mode (hw inverts upper bit of U and V)
TEX_COORD_TYPE	26:25	none	Specifies coordinate type. <u>POSSIBLE VALUES:</u> 00 - 2D 01 - 3D 02 - Cube 03 - Reserved
CACHE	31:27	none	This field is ignored on R520 and RV510. <u>POSSIBLE VALUES:</u> 00 - WHOLE 01 - Reserved 02 - HALF_REGION_0 03 - HALF_REGION_1 04 - FOURTH_REGION_0 05 - FOURTH_REGION_1 06 - FOURTH_REGION_2 07 - FOURTH_REGION_3 08 - EIGHTH_REGION_0

			09 - EIGHTH_REGION_1 10 - EIGHTH_REGION_2 11 - EIGHTH_REGION_3 12 - EIGHTH_REGION_4 13 - EIGHTH_REGION_5 14 - EIGHTH_REGION_6 15 - EIGHTH_REGION_7 16 - SIXTEENTH_REGION_0 17 - SIXTEENTH_REGION_1 18 - SIXTEENTH_REGION_2 19 - SIXTEENTH_REGION_3 20 - SIXTEENTH_REGION_4 21 - SIXTEENTH_REGION_5 22 - SIXTEENTH_REGION_6 23 - SIXTEENTH_REGION_7 24 - SIXTEENTH_REGION_8 25 - SIXTEENTH_REGION_9 26 - SIXTEENTH_REGION_A 27 - SIXTEENTH_REGION_B 28 - SIXTEENTH_REGION_C 29 - SIXTEENTH_REGION_D 30 - SIXTEENTH_REGION_E 31 - SIXTEENTH_REGION_F
--	--	--	--

TX:TX_FORMAT2 [0-15] · [R/W] · 32 bits · Access: 8/16/32 · MMReg:0x4500-0x453c			
DESCRIPTION: Texture Format State			
Field Name	Bits	Default	Description
TXPITCH	13:0	none	Used instead of TXWIDTH for image addressing when TXPITCH_EN is asserted. Pitch is given as number of texels minus one. Maximum pitch is 16K texels.
TXFORMAT_MSB	14	none	Specifies the MSB of the texture format to extend the number of formats to 64.
TXWIDTH_11	15	none	Specifies bit 11 of TXWIDTH to extend the largest image to 4096 texels.
TXHEIGHT_11	16	none	Specifies bit 11 of TXHEIGHT to extend the largest image to 4096 texels.
POW2FIX2FLT	17	none	Optionally divide by 256 instead of 255 during fix2float. Can only be asserted for 8-bit components. <u>POSSIBLE VALUES:</u> 00 - Divide by pow2-1 for fix2float (default) 01 - Divide by pow2 for fix2float
SEL_FILTER4	19:18	none	If filter4 is enabled, specifies which texture component to apply filter4 to. <u>POSSIBLE VALUES:</u> 00 - Select Texture Component0. 01 - Select Texture Component1.

			02 - Select Texture Component2. 03 - Select Texture Component3.
--	--	--	--

TX:TX_INVALIDTAGS · [R/W] · 32 bits · Access: 8/16/32 · MMReg:0x4100			
DESCRIPTION: <i>Invalidate texture cache tags</i>			
Field Name	Bits	Default	Description
RESERVED	31:0	none	Unused

TX:TX_OFFSET_[0-15] · [R/W] · 32 bits · Access: 8/16/32 · MMReg:0x4540-0x457c			
DESCRIPTION: <i>Texture Offset State</i>			
Field Name	Bits	Default	Description
ENDIAN_SWAP	1:0	none	Endian Control <u>POSSIBLE VALUES:</u> 00 - No swap 01 - 16 bit swap 02 - 32 bit swap 03 - Half-DWORD swap
MACRO_TILE	2	none	Macro Tile Control <u>POSSIBLE VALUES:</u> 00 - 2KB page is linear 01 - 2KB page is tiled
MICRO_TILE	4:3	none	Micro Tile Control <u>POSSIBLE VALUES:</u> 00 - 32 byte cache line is linear 01 - 32 byte cache line is tiled 02 - 32 byte cache line is tiled square (only applies to 16-bit texel) 03 - Reserved
TXOFFSET	31:5	none	32-byte aligned pointer to base map

10.9 Fragment Shader Registers

US:US_ALU_ALPHA_INST_[0-511] · [R/W] · 32 bits · Access: 8/16/32 · MMReg:0xa800-0xaffc			
DESCRIPTION: ALU Alpha Instruction			
Field Name	Bits	Default	Description
ALPHA_OP	3:0	0x0	<p>Specifies the opcode for this instruction.</p> <p>POSSIBLE VALUES:</p> <ul style="list-style-type: none"> 00 - OP_MAD: Result = A*B + C 01 - OP_DP: Result = dot product from RGB ALU 02 - OP_MIN: Result = min(A,B) 03 - OP_MAX: Result = max(A,B) 04 - reserved 05 - OP_CND: Result = cnd(A,B,C) = (C>0.5)?A:B 06 - OP_CMP: Result = cmp(A,B,C) = (C>=0.0)?A:B 07 - OP_FRC: Result = A-floor(A) 08 - OP_EX2: Result = 2^^A 09 - OP_LN2: Result = log2(A) 10 - OP_RCP: Result = 1/A 11 - OP_RSQ: Result = 1/sqrt(A) 12 - OP_SIN: Result = sin(A*2pi) 13 - OP_COS: Result = cos(A*2pi) 14 - OP_MDH: Result = A*B + C; A is always topleft.src0, C is always topright.src0 (source select and swizzles ignored). Input modifiers are respected for all inputs. 15 - OP_MDV: Result = A*B + C; A is always topleft.src0, C is always bottomleft.src0 (source select and swizzles ignored). Input modifiers are respected for all inputs.
ALPHA_ADDRD	10:4	0x0	Specifies the address of the pixel stack frame register to which the Alpha result of this instruction is to be written.
ALPHA_ADDRD_REL	11	0x0	<p>Specifies whether the loop register is added to the value of ALPHA_ADDRD before it is used. This implements relative addressing.</p> <p>POSSIBLE VALUES:</p> <ul style="list-style-type: none"> 00 - NONE: Do not modify destination address. 01 - RELATIVE: Add aL to address before write.
ALPHA_SEL_A	13:12	0x0	<p>Specifies the operands for Alpha inputs A and B.</p> <p>POSSIBLE VALUES:</p> <ul style="list-style-type: none"> 00 - src0 01 - src1 02 - src2 03 - srcp
ALPHA_SWIZ_A	16:14	0x0	Specifies the channel sources for Alpha inputs A and B.

			<p><u>POSSIBLE VALUES:</u></p> <ul style="list-style-type: none"> 00 - Red 01 - Green 02 - Blue 03 - Alpha 04 - Zero 05 - Half 06 - One 07 - Unused
ALPHA_MOD_A	18:17	0x0	<p>Specifies the input modifiers for Alpha inputs A and B.</p> <p><u>POSSIBLE VALUES:</u></p> <ul style="list-style-type: none"> 00 - NOP: Do not modify input 01 - NEG: Negate input 02 - ABS: Take absolute value of input 03 - NAB: Take negative absolute value of input
ALPHA_SEL_B	20:19	0x0	<p>Specifies the operands for Alpha inputs A and B.</p> <p><u>POSSIBLE VALUES:</u></p> <ul style="list-style-type: none"> 00 - src0 01 - src1 02 - src2 03 - srcp
ALPHA_SWIZ_B	23:21	0x0	<p>Specifies the channel sources for Alpha inputs A and B.</p> <p><u>POSSIBLE VALUES:</u></p> <ul style="list-style-type: none"> 00 - Red 01 - Green 02 - Blue 03 - Alpha 04 - Zero 05 - Half 06 - One 07 - Unused
ALPHA_MOD_B	25:24	0x0	<p>Specifies the input modifiers for Alpha inputs A and B.</p> <p><u>POSSIBLE VALUES:</u></p> <ul style="list-style-type: none"> 00 - NOP: Do not modify input 01 - NEG: Negate input 02 - ABS: Take absolute value of input 03 - NAB: Take negative absolute value of input
OMOD	28:26	0x0	<p>Specifies the output modifier for this instruction.</p> <p><u>POSSIBLE VALUES:</u></p> <ul style="list-style-type: none"> 00 - Result * 1 01 - Result * 2 02 - Result * 4 03 - Result * 8 04 - Result / 2

			<p>05 - Result / 4 06 - Result / 8 07 - Disable output modifier and clamping (result is copied exactly; only valid for MIN/MAX/CMP/CND)</p>
TARGET	30:29	0x0	<p>This specifies which (cached) frame buffer target to write to. For non-output ALU instructions, this specifies how to compare the results against zero when setting the predicate bits.</p> <p><u>POSSIBLE VALUES:</u> 00 - A: Output to render target A. Predicate == (ALU) 01 - B: Output to render target B. Predicate < (ALU) 02 - C: Output to render target C. Predicate >= (ALU) 03 - D: Output to render target D. Predicate != (ALU)</p>
W_OMASK	31	0x0	<p>Specifies whether or not to write the Alpha component of the result of this instruction to the depth output fifo.</p> <p><u>POSSIBLE VALUES:</u> 00 - NONE: Do not write output to w. 01 - A: Write the alpha channel only to w.</p>

US:US_ALU_ALPHA_ADDR [0-511] · [R/W] · 32 bits · Access: 8/16/32 · MMReg:0x9800-0x9ffc			
<p>DESCRIPTION: This table specifies the Alpha source addresses and pre-subtract operation for up to 512 ALU instruction. The ALU expects 6 source operands - three for color (rgb0, rgb1, rgb2) and three for alpha (a0, a1, a2). The pre-subtract operation creates two more (rgbp and ap).</p>			
Field Name	Bits	Default	Description
ADDR0	7:0	0x0	<p>Specifies the identity of source operands a0, a1, and a2. If the const field is set, this number ranges from 0 to 255 and specifies a location within the constant register bank. Otherwise: If the most significant bit is cleared, this field specifies a location within the current pixel stack frame (ranging from 0 to 127). If the most significant bit is set, then the lower 7 bits specify an inline unsigned floating-point constant with 4 bit exponent (bias 7) and 3 bit mantissa, including denormals but excluding infinite/NaN.</p>
ADDR0_CONST	8	0x0	<p>Specifies whether the associated address is a constant register address or a temporary address / inline constant.</p> <p><u>POSSIBLE VALUES:</u> 00 - TEMPORARY: Address temporary register or inline constant value. 01 - CONSTANT: Address constant register.</p>
ADDR0_REL	9	0x0	<p>Specifies whether the loop register is added to the value of the associated address before it is used. This implements relative addressing.</p>

			<p><u>POSSIBLE VALUES:</u> 00 - NONE: Do not modify source address. 01 - RELATIVE: Add aL before lookup.</p>
ADDR1	17:10	0x0	<p>Specifies the identity of source operands a0, a1, and a2. If the const field is set, this number ranges from 0 to 255 and specifies a location within the constant register bank. Otherwise: If the most significant bit is cleared, this field specifies a location within the current pixel stack frame (ranging from 0 to 127). If the most significant bit is set, then the lower 7 bits specify an inline unsigned floating-point constant with 4 bit exponent (bias 7) and 3 bit mantissa, including denormals but excluding infinite/NaN.</p>
ADDR1_CONST	18	0x0	<p>Specifies whether the associated address is a constant register address or a temporary address / inline constant.</p> <p><u>POSSIBLE VALUES:</u> 00 - TEMPORARY: Address temporary register or inline constant value. 01 - CONSTANT: Address constant register.</p>
ADDR1_REL	19	0x0	<p>Specifies whether the loop register is added to the value of the associated address before it is used. This implements relative addressing.</p> <p><u>POSSIBLE VALUES:</u> 00 - NONE: Do not modify source address. 01 - RELATIVE: Add aL before lookup.</p>
ADDR2	27:20	0x0	<p>Specifies the identity of source operands a0, a1, and a2. If the const field is set, this number ranges from 0 to 255 and specifies a location within the constant register bank. Otherwise: If the most significant bit is cleared, this field specifies a location within the current pixel stack frame (ranging from 0 to 127). If the most significant bit is set, then the lower 7 bits specify an inline unsigned floating-point constant with 4 bit exponent (bias 7) and 3 bit mantissa, including denormals but excluding infinite/NaN.</p>
ADDR2_CONST	28	0x0	<p>Specifies whether the associated address is a constant register address or a temporary address / inline constant.</p> <p><u>POSSIBLE VALUES:</u> 00 - TEMPORARY: Address temporary register or inline constant value. 01 - CONSTANT: Address constant register.</p>
ADDR2_REL	29	0x0	<p>Specifies whether the loop register is added to the value of the associated address before it is used. This implements relative addressing.</p> <p><u>POSSIBLE VALUES:</u></p>

			00 - NONE: Do not modify source address. 01 - RELATIVE: Add aL before lookup.
SRCP_OP	31:30	0x0	Specifies how the pre-subtract value (SRCP) is computed. <u>POSSIBLE VALUES:</u> 00 - 1.0-2.0*A0 01 - A1-A0 02 - A1+A0 03 - 1.0-A0

US:US_ALU_RGBA_INST_[0-511] · [R/W] · 32 bits · Access: 8/16/32 · MMReg:0xb000-0xb7fc			
DESCRIPTION: ALU Shared RGBA Instruction			
Field Name	Bits	Default	Description
RGB_OP	3:0	0x0	Specifies the opcode for this instruction. <u>POSSIBLE VALUES:</u> 00 - OP_MAD: Result = A*B + C 01 - OP_DP3: Result = A.r*B.r + A.g*B.g + A.b*B.b 02 - OP_DP4: Result = A.r*B.r + A.g*B.g + A.b*B.b + A.a*B.a 03 - OP_D2A: Result = A.r*B.r + A.g*B.g + C.b 04 - OP_MIN: Result = min(A,B) 05 - OP_MAX: Result = max(A,B) 06 - reserved 07 - OP_CND: Result = cnd(A,B,C) = (C>0.5)?A:B 08 - OP_CMP: Result = cmp(A,B,C) = (C>=0.0)?A:B 09 - OP_FRC: Result = A-floor(A) 10 - OP_SOP: Result = ex2,ln2,rcp,rsq,sin,cos from Alpha ALU 11 - OP_MDH: Result = A*B + C; A is always topleft.src0, C is always topright.src0 (source select and swizzles ignored). Input modifiers are respected for all inputs. 12 - OP_MDV: Result = A*B + C; A is always topleft.src0, C is always bottomleft.src0 (source select and swizzles ignored). Input modifiers are respected for all inputs.
RGB_ADDRD	10:4	0x0	Specifies the address of the pixel stack frame register to which the RGB result of this instruction is to be written.
RGB_ADDRD_REL	11	0x0	Specifies whether the loop register is added to the value of RGB_ADDRD before it is used. This implements relative addressing. <u>POSSIBLE VALUES:</u> 00 - NONE: Do not modify destination address. 01 - RELATIVE: Add aL to address before write.

RGB_SEL_C	13:12	0x0	Specifies the operands for RGB and Alpha input C. <u>POSSIBLE VALUES:</u> 00 - src0 01 - src1 02 - src2 03 - srcp
RED_SWIZ_C	16:14	0x0	Specifies, per channel, the sources for RGB and Alpha input C. <u>POSSIBLE VALUES:</u> 00 - Red 01 - Green 02 - Blue 03 - Alpha 04 - Zero 05 - Half 06 - One 07 - Unused
GREEN_SWIZ_C	19:17	0x0	Specifies, per channel, the sources for RGB and Alpha input C. <u>POSSIBLE VALUES:</u> 00 - Red 01 - Green 02 - Blue 03 - Alpha 04 - Zero 05 - Half 06 - One 07 - Unused
BLUE_SWIZ_C	22:20	0x0	Specifies, per channel, the sources for RGB and Alpha input C. <u>POSSIBLE VALUES:</u> 00 - Red 01 - Green 02 - Blue 03 - Alpha 04 - Zero 05 - Half 06 - One 07 - Unused
RGB_MOD_C	24:23	0x0	Specifies the input modifiers for RGB and Alpha input C. <u>POSSIBLE VALUES:</u> 00 - NOP: Do not modify input 01 - NEG: Negate input 02 - ABS: Take absolute value of input 03 - NAB: Take negative absolute value of input

ALPHA_SEL_C	26:25	0x0	Specifies the operands for RGB and Alpha input C. <u>POSSIBLE VALUES:</u> 00 - src0 01 - src1 02 - src2 03 - srcp
ALPHA_SWIZ_C	29:27	0x0	Specifies, per channel, the sources for RGB and Alpha input C. <u>POSSIBLE VALUES:</u> 00 - Red 01 - Green 02 - Blue 03 - Alpha 04 - Zero 05 - Half 06 - One 07 - Unused
ALPHA_MOD_C	31:30	0x0	Specifies the input modifiers for RGB and Alpha input C. <u>POSSIBLE VALUES:</u> 00 - NOP: Do not modify input 01 - NEG: Negate input 02 - ABS: Take absolute value of input 03 - NAB: Take negative absolute value of input

US:US_ALU_RGB_INST_[0-511] · [R/W] · 32 bits · Access: 8/16/32 · MMReg:0xa000-0xa7fc			
DESCRIPTION: ALU RGB Instruction			
Field Name	Bits	Default	Description
RGB_SEL_A	1:0	0x0	Specifies the operands for RGB inputs A and B. <u>POSSIBLE VALUES:</u> 00 - src0 01 - src1 02 - src2 03 - srcp
RED_SWIZ_A	4:2	0x0	Specifies, per channel, the sources for RGB inputs A and B. <u>POSSIBLE VALUES:</u> 00 - Red 01 - Green 02 - Blue 03 - Alpha 04 - Zero 05 - Half

			06 - One 07 - Unused
GREEN_SWIZ_A	7:5	0x0	Specifies, per channel, the sources for RGB inputs A and B. <u>POSSIBLE VALUES:</u> 00 - Red 01 - Green 02 - Blue 03 - Alpha 04 - Zero 05 - Half 06 - One 07 - Unused
BLUE_SWIZ_A	10:8	0x0	Specifies, per channel, the sources for RGB inputs A and B. <u>POSSIBLE VALUES:</u> 00 - Red 01 - Green 02 - Blue 03 - Alpha 04 - Zero 05 - Half 06 - One 07 - Unused
RGB_MOD_A	12:11	0x0	Specifies the input modifiers for RGB inputs A and B. <u>POSSIBLE VALUES:</u> 00 - NOP: Do not modify input 01 - NEG: Negate input 02 - ABS: Take absolute value of input 03 - NAB: Take negative absolute value of input
RGB_SEL_B	14:13	0x0	Specifies the operands for RGB inputs A and B. <u>POSSIBLE VALUES:</u> 00 - src0 01 - src1 02 - src2 03 - srcp
RED_SWIZ_B	17:15	0x0	Specifies, per channel, the sources for RGB inputs A and B. <u>POSSIBLE VALUES:</u> 00 - Red 01 - Green 02 - Blue 03 - Alpha 04 - Zero 05 - Half

			06 - One 07 - Unused
GREEN_SWIZ_B	20:18	0x0	Specifies, per channel, the sources for RGB inputs A and B. <u>POSSIBLE VALUES:</u> 00 - Red 01 - Green 02 - Blue 03 - Alpha 04 - Zero 05 - Half 06 - One 07 - Unused
BLUE_SWIZ_B	23:21	0x0	Specifies, per channel, the sources for RGB inputs A and B. <u>POSSIBLE VALUES:</u> 00 - Red 01 - Green 02 - Blue 03 - Alpha 04 - Zero 05 - Half 06 - One 07 - Unused
RGB_MOD_B	25:24	0x0	Specifies the input modifiers for RGB inputs A and B. <u>POSSIBLE VALUES:</u> 00 - NOP: Do not modify input 01 - NEG: Negate input 02 - ABS: Take absolute value of input 03 - NAB: Take negative absolute value of input
OMOD	28:26	0x0	Specifies the output modifier for this instruction. <u>POSSIBLE VALUES:</u> 00 - Result * 1 01 - Result * 2 02 - Result * 4 03 - Result * 8 04 - Result / 2 05 - Result / 4 06 - Result / 8 07 - Disable output modifier and clamping (result is copied exactly; only valid for MIN/MAX/CMP/CND)
TARGET	30:29	0x0	This specifies which (cached) frame buffer target to write to. For non-output ALU instructions, this specifies how to compare the results against zero when setting the predicate bits.

			<p>POSSIBLE VALUES:</p> <p>00 - A: Output to render target A. Predicate == (ALU)</p> <p>01 - B: Output to render target B. Predicate < (ALU)</p> <p>02 - C: Output to render target C. Predicate >= (ALU)</p> <p>03 - D: Output to render target D. Predicate != (ALU)</p>
ALU_WMASK	31	0x0	<p>Specifies whether to update the current ALU result.</p> <p>POSSIBLE VALUES:</p> <p>00 - Do not modify the current ALU result.</p> <p>01 - Modify the current ALU result based on the settings of ALU_RESULT_SEL and ALU_RESULT_OP.</p>

US:US_ALU_RGB_ADDR_[0-511] · [R/W] · 32 bits · Access: 8/16/32 · MMReg:0x9000-0x97fc			
<p>DESCRIPTION: This table specifies the RGB source addresses and pre-subtract operation for up to 512 ALU instructions. The ALU expects 6 source operands - three for color (rgb0, rgb1, rgb2) and three for alpha (a0, a1, a2). The pre-subtract operation creates two more (rgbp and ap).</p>			
Field Name	Bits	Default	Description
ADDR0	7:0	0x0	Specifies the identity of source operands rgb0, rgb1, and rgb2. If the const field is set, this number ranges from 0 to 255 and specifies a location within the constant register bank. Otherwise: If the most significant bit is cleared, this field specifies a location within the current pixel stack frame (ranging from 0 to 127). If the most significant bit is set, then the lower 7 bits specify an inline unsigned floating-point constant with 4 bit exponent (bias 7) and 3 bit mantissa, including denormals but excluding infinite/NaN.
ADDR0_CONST	8	0x0	Specifies whether the associated address is a constant register address or a temporary address / inline constant.
			<p>POSSIBLE VALUES:</p> <p>00 - TEMPORARY: Address temporary register or inline constant value.</p> <p>01 - CONSTANT: Address constant register.</p>
ADDR0_REL	9	0x0	Specifies whether the loop register is added to the value of the associated address before it is used. This implements relative addressing.
			<p>POSSIBLE VALUES:</p> <p>00 - NONE: Do not modify source address.</p> <p>01 - RELATIVE: Add aL before lookup.</p>
ADDR1	17:10	0x0	Specifies the identity of source operands rgb0, rgb1, and rgb2. If the const field is set, this number ranges from 0 to 255 and specifies a location within the constant

			register bank. Otherwise: If the most significant bit is cleared, this field specifies a location within the current pixel stack frame (ranging from 0 to 127). If the most significant bit is set, then the lower 7 bits specify an inline unsigned floating-point constant with 4 bit exponent (bias 7) and 3 bit mantissa, including denormals but excluding infinite/NaN.
ADDR1_CONST	18	0x0	Specifies whether the associated address is a constant register address or a temporary address / inline constant. <u>POSSIBLE VALUES:</u> 00 - TEMPORARY: Address temporary register or inline constant value. 01 - CONSTANT: Address constant register.
ADDR1_REL	19	0x0	Specifies whether the loop register is added to the value of the associated address before it is used. This implements relative addressing. <u>POSSIBLE VALUES:</u> 00 - NONE: Do not modify source address. 01 - RELATIVE: Add aL before lookup.
ADDR2	27:20	0x0	Specifies the identity of source operands rgb0, rgb1, and rgb2. If the const field is set, this number ranges from 0 to 255 and specifies a location within the constant register bank. Otherwise: If the most significant bit is cleared, this field specifies a location within the current pixel stack frame (ranging from 0 to 127). If the most significant bit is set, then the lower 7 bits specify an inline unsigned floating-point constant with 4 bit exponent (bias 7) and 3 bit mantissa, including denormals but excluding infinite/NaN.
ADDR2_CONST	28	0x0	Specifies whether the associated address is a constant register address or a temporary address / inline constant. <u>POSSIBLE VALUES:</u> 00 - TEMPORARY: Address temporary register or inline constant value. 01 - CONSTANT: Address constant register.
ADDR2_REL	29	0x0	Specifies whether the loop register is added to the value of the associated address before it is used. This implements relative addressing. <u>POSSIBLE VALUES:</u> 00 - NONE: Do not modify source address. 01 - RELATIVE: Add aL before lookup.
SRCP_OP	31:30	0x0	Specifies how the pre-subtract value (SRCP) is computed. <u>POSSIBLE VALUES:</u> 00 - 1.0-2.0*RGB0

			01 - RGB1-RGB0 02 - RGB1+RGB0 03 - 1.0-RGB0
--	--	--	---

US:US_CMN_INST_[0-511] · [R/W] · 32 bits · Access: 8/16/32 · MMReg:0xb800-0xbffc			
DESCRIPTION: Shared instruction fields for all instruction types			
Field Name	Bits	Default	Description
TYPE	1:0	0x0	Specifies the type of instruction. Note that output instructions write to render targets. <u>POSSIBLE VALUES:</u> 00 - US_INST_TYPE_ALU: This instruction is an ALU instruction. 01 - US_INST_TYPE_OUT: This instruction is an output instruction. 02 - US_INST_TYPE_FC: This instruction is a flow control instruction. 03 - US_INST_TYPE_TEX: This instruction is a texture instruction.
TEX_SEM_WAIT	2	0x0	Specifies whether to wait for the texture semaphore. <u>POSSIBLE VALUES:</u> 00 - This instruction may issue immediately. 01 - This instruction will not issue until the texture semaphore is available.
RGB_PRED_SEL	5:3	0x0	Specifies whether the instruction uses predication. For ALU/TEX/Output this specifies predication for the RGB channels only. For FC this specifies the predicate for the entire instruction. <u>POSSIBLE VALUES:</u> 00 - US_PRED_SEL_NONE: No predication 01 - US_PRED_SEL_RGBA: Independent Channel Predication 02 - US_PRED_SEL_RRRR: R-Replicate Predication 03 - US_PRED_SEL_GGGG: G-Replicate Predication 04 - US_PRED_SEL_BBBB: B-Replicate Predication 05 - US_PRED_SEL_AAAA: A-Replicate Predication
RGB_PRED_INV	6	0x0	Specifies whether the predicate should be inverted. For ALU/TEX/Output this specifies predication for the RGB channels only. For FC this specifies the predicate for the entire instruction. <u>POSSIBLE VALUES:</u> 00 - Normal predication

			01 - Invert the value of the predicate
WRITE_INACTIVE	7	0x0	Specifies which pixels to write to. <u>POSSIBLE VALUES:</u> 00 - Only write to channels of active pixels 01 - Write to channels of all pixels, including inactive pixels
LAST	8	0x0	Specifies whether this is the last instruction. <u>POSSIBLE VALUES:</u> 00 - Do not terminate the shader after executing this instruction (unless this instruction is at END_ADDR). 01 - All active pixels are willing to terminate after executing this instruction. There is no guarantee that the shader will actually terminate here. This feature is provided as a performance optimization for tests where pixels can conditionally terminate early.
NOP	9	0x0	Specifies whether to insert a NOP instruction after this. This would get specified in order to meet dependency requirements for the pre-subtract inputs, and dependency requirements for src0 of an MDH/MDV instruction. <u>POSSIBLE VALUES:</u> 00 - Do not insert NOP instruction after this one. 01 - Insert a NOP instruction after this one.
ALU_WAIT	10	0x0	Specifies whether to wait for pending ALU instructions to complete before issuing this instruction. <u>POSSIBLE VALUES:</u> 00 - Do not wait for pending ALU instructions to complete before issuing the current instruction. 01 - Wait for pending ALU instructions to complete before issuing the current instruction.
RGB_WMASK	13:11	0x0	Specifies which components of the result of the RGB instruction are written to the pixel stack frame. <u>POSSIBLE VALUES:</u> 00 - NONE: Do not write any output. 01 - R: Write the red channel only. 02 - G: Write the green channel only. 03 - RG: Write the red and green channels. 04 - B: Write the blue channel only. 05 - RB: Write the red and blue channels. 06 - GB: Write the green and blue channels. 07 - RGB: Write the red, green, and blue channels.
ALPHA_WMASK	14	0x0	Specifies whether the result of the Alpha instruction is written to the pixel stack frame. <u>POSSIBLE VALUES:</u> 00 - NONE: Do not write register.

			01 - A: Write the alpha channel only.
RGB_OMASK	17:15	0x0	<p>Specifies which components of the result of the RGB instruction are written to the output fifo if this is an output instruction, and which predicate bits should be modified if this is an ALU instruction.</p> <p><u>POSSIBLE VALUES:</u></p> <ul style="list-style-type: none"> 00 - NONE: Do not write any output. 01 - R: Write the red channel only. 02 - G: Write the green channel only. 03 - RG: Write the red and green channels. 04 - B: Write the blue channel only. 05 - RB: Write the red and blue channels. 06 - GB: Write the green and blue channels. 07 - RGB: Write the red, green, and blue channels.
ALPHA_OMASK	18	0x0	<p>Specifies whether the result of the Alpha instruction is written to the output fifo if this is an output instruction, and whether the Alpha predicate bit should be modified if this is an ALU instruction.</p> <p><u>POSSIBLE VALUES:</u></p> <ul style="list-style-type: none"> 00 - NONE: Do not write output. 01 - A: Write the alpha channel only.
RGB_CLAMP	19	0x0	<p>Specifies RGB and Alpha clamp mode for this instruction.</p> <p><u>POSSIBLE VALUES:</u></p> <ul style="list-style-type: none"> 00 - Do not clamp output. 01 - Clamp output to the range [0,1].
ALPHA_CLAMP	20	0x0	<p>Specifies RGB and Alpha clamp mode for this instruction.</p> <p><u>POSSIBLE VALUES:</u></p> <ul style="list-style-type: none"> 00 - Do not clamp output. 01 - Clamp output to the range [0,1].
ALU_RESULT_SEL	21	0x0	<p>Specifies which component of the result of this instruction should be used as the `ALU result` by a subsequent flow control instruction.</p> <p><u>POSSIBLE VALUES:</u></p> <ul style="list-style-type: none"> 00 - RED: Use red as ALU result for FC. 01 - ALPHA: Use alpha as ALU result for FC.
ALPHA_PRED_INV	22	0x0	<p>Specifies whether the predicate should be inverted. For ALU/TEX/Output this specifies predication for the alpha channel only. This field has no effect on FC instructions.</p> <p><u>POSSIBLE VALUES:</u></p> <ul style="list-style-type: none"> 00 - Normal predication 01 - Invert the value of the predicate

ALU_RESULT_OP	24:23	0x0	Specifies how to compare the ALU result against zero for the `alu_result` bit in a subsequent flow control instruction. <u>POSSIBLE VALUES:</u> 00 - Equal to 01 - Less than 02 - Greater than or equal to 03 - Not equal
ALPHA_PRED_SEL	27:25	0x0	Specifies whether the instruction uses predication. For ALU/TEX/Output this specifies predication for the alpha channel only. This field has no effect on FC instructions. <u>POSSIBLE VALUES:</u> 00 - US_PRED_SEL_NONE: No predication 01 - US_PRED_SEL_RGBA: A predication (identical to US_PRED_SEL_AAAA) 02 - US_PRED_SEL_RRRR: R Predication 03 - US_PRED_SEL_GGGG: G Predication 04 - US_PRED_SEL_BBBB: B Predication 05 - US_PRED_SEL_AAAA: A Predication
STAT_WE	31:28	0x0	Specifies which components (R,G,B,A) contribute to the stat count

US:US_CODE_ADDR · [R/W] · 32 bits · Access: 8/16/32 · MMReg:0x4630			
DESCRIPTION: Code start and end instruction addresses.			
Field Name	Bits	Default	Description
START_ADDR	8:0	0x0	Specifies the address of the first instruction to execute in the shader program. This address is relative to the shader program offset given in US_CODE_OFFSET.OFFSET_ADDR.
END_ADDR	24:16	0x0	Specifies the address of the last instruction to execute in the shader program. This address is relative to the shader program offset given in US_CODE_OFFSET.OFFSET_ADDR. Shader program execution will always terminate after the instruction at this address is executed.

US:US_CODE_OFFSET · [R/W] · 32 bits · Access: 8/16/32 · MMReg:0x4638			
DESCRIPTION: Offsets used for relative instruction addresses in the shader program, including START_ADDR, END_ADDR, and any non-global flow control jump addresses.			
Field Name	Bits	Default	Description
OFFSET_ADDR	8:0	0x0	Specifies the offset to add to relative instruction addresses, including START_ADDR, END_ADDR, and some flow control jump addresses.

US:US_CODE_RANGE · [R/W] · 32 bits · Access: 8/16/32 · MMReg:0x4634			
DESCRIPTION: <i>Range of instructions that contains the current shader program.</i>			
Field Name	Bits	Default	Description
CODE_ADDR	8:0	0x0	Specifies the start address of the current code window. This address is an absolute address.
CODE_SIZE	24:16	0x0	Specifies the size of the current code window, minus one. The last instruction in the code window is given by CODE_ADDR + CODE_SIZE.

US:US_CONFIG · [R/W] · 32 bits · Access: 8/16/32 · MMReg:0x4600			
DESCRIPTION: <i>Shader Configuration</i>			
Field Name	Bits	Default	Description
Reserved	0	0x0	Set to 0
ZERO_TIMES_ANYTHING_EQUALS_ZERO	1	0x0	Control how ALU multiplier behaves when one argument is zero. This affects the multiplier used in MAD and dot product calculations. POSSIBLE VALUES: 00 - Default behaviour (0*inf=nan,0*nan=nan) 01 - Legacy behaviour for shader model 1 (0*anything=0)

US:US_FC_ADDR [0-511] · [R/W] · 32 bits · Access: 8/16/32 · MMReg:0xa000-0xa7fc			
DESCRIPTION: <i>Flow Control Instruction Address Fields</i>			
Field Name	Bits	Default	Description
BOOL_ADDR	4:0	0x0	The address of the static boolean register to use in the jump function.
INT_ADDR	12:8	0x0	The address of the static integer register to use for loop/rep and endloop/endrep.
JUMP_ADDR	24:16	0x0	The address to jump to if the jump function evaluates to true.
JUMP_GLOBAL	31	0x0	Specifies whether to interpret JUMP_ADDR as a global address. POSSIBLE VALUES: 00 - Add the shader program offset in US_CODE_OFFSET.OFFSET_ADDR when calculating the destination address of a jump 01 - Don't use the shader program offset when calculating the destination address jump

US:US_FC_BOOL_CONST · [R/W] · 32 bits · Access: 8/16/32 · MMReg:0x4620			
DESCRIPTION: <i>Static Boolean Constants for Flow Control Branching Instructions. Quad-buffered.</i>			

Field Name	Bits	Default	Description
KBOOL	31:0	0x0	Specifies the boolean value for constants 0-31.

US:US_FC_CTRL · [R/W] · 32 bits · Access: 8/16/32 · MMRReg:0x4624			
DESCRIPTION: <i>Flow Control Options. Quad-buffered.</i>			
Field Name	Bits	Default	Description
TEST_EN	30	0x0	Specifies whether test mode is enabled. This flag currently has no effect in hardware. <u>POSSIBLE VALUES:</u> 00 - Normal mode 01 - Test mode (currently unused)
FULL_FC_EN	31	0x0	Specifies whether full flow control functionality is enabled. <u>POSSIBLE VALUES:</u> 00 - Use partial flow-control (enables twice the contexts). Loops and subroutines are not available in partial flow-control mode, and the nesting depth of branch statements is limited. 01 - Use full pixel shader 3.0 flow control, including loops and subroutines.

US:US_FC_INST_[0-511] · [R/W] · 32 bits · Access: 8/16/32 · MMRReg:0x9800-0x9ffc			
DESCRIPTION: <i>Flow Control Instruction</i>			
Field Name	Bits	Default	Description
OP	2:0	0x0	Specifies the type of flow control instruction. <u>POSSIBLE VALUES:</u> 00 - US_FC_OP_JUMP: (if, endif, call, etc) 01 - US_FC_OP_LOOP: same as jump except always take the jump if the static counter is 0. If we don't take the jump, push initial loop counter and loop register (aL) values onto the loop stack. 02 - US_FC_OP_ENDLOOP: same as jump but decrement the loop counter and increment the loop register (aL), and don't take the jump if the loop counter becomes zero. 03 - US_FC_OP_REP: same as loop but don't push the loop register aL. 04 - US_FC_OP_ENDREP: same as endloop but don't update/pop the loop register aL. 05 - US_FC_OP_BREAKLOOP: same as jump but pops the loop stacks if a pixel stops being active. 06 - US_FC_OP_BREAKREP: same as breakloop but don't pop the loop register if it jumps.

			07 - US_FC_OP_CONTINUE: used to disable pixels that are ready to jump to the ENDLOOP/ENDREP instruction.
B_ELSE	4	0x0	<p>Specifies whether to perform an else operation on the active and branch-inactive pixels before executing the instruction.</p> <p><u>POSSIBLE VALUES:</u></p> <p>00 - Don't alter the branch state before executing the instruction.</p> <p>01 - Perform an else operation on the branch state before executing the instruction; pixels in the active state are moved to the branch inactive state with zero counter, and vice versa.</p>
JUMP_ANY	5	0x0	<p>If set, jump if any active pixels want to take the jump (otherwise the instruction jumps only if all active pixels want to).</p> <p><u>POSSIBLE VALUES:</u></p> <p>00 - Jump if ALL active pixels want to take the jump (for if and else). If no pixels are active, jump.</p> <p>01 - Jump if ANY active pixels want to take the jump (for call, loop/rep and endrep/endloop). If no pixels are active, do not jump.</p>
A_OP	7:6	0x0	<p>The address stack operation to perform if we take the jump.</p> <p><u>POSSIBLE VALUES:</u></p> <p>00 - US_FC_A_OP_NONE: Don't change the address stack</p> <p>01 - US_FC_A_OP_POP: If we jump, pop the address stack and use that value for the jump target</p> <p>02 - US_FC_A_OP_PUSH: If we jump, push the current address onto the address stack</p>
JUMP_FUNC	15:8	0x0	<p>A 2x2x2 table of boolean values indicating whether to take the jump. The table index is indexed by {ALU Compare Result, Predication Result, Boolean Value (from the static boolean address in US_FC_ADDR.BOOL)}. To determine whether to jump, look at bit ((alu_result<<2) (predicate<<1) bool).</p>
B_POP_CNT	20:16	0x0	<p>The amount to decrement the branch counter by if US_FC_B_OP_DECR operation is performed.</p>
B_OP0	25:24	0x0	<p>The branch state operation to perform if we don't take the jump.</p> <p><u>POSSIBLE VALUES:</u></p> <p>00 - US_FC_B_OP_NONE: If we don't jump, don't alter the branch counter for any pixel.</p> <p>01 - US_FC_B_OP_DECR: If we don't jump, decrement branch counter by B_POP_CNT for inactive</p>

			pixels. Activate pixels with negative counters. 02 - US_FC_B_OP_INCR: If we don't jump, increment branch counter by 1 for inactive pixels. Deactivate pixels that decided to jump and set their counter to zero.
B_OP1	27:26	0x0	The branch state operation to perform if we do take the jump. <u>POSSIBLE VALUES:</u> 00 - US_FC_B_OP_NONE: If we do jump, don't alter the branch counter for any pixel. 01 - US_FC_B_OP_DECR: If we do jump, decrement branch counter by B_POP_CNT for inactive pixels. Activate pixels with negative counters. 02 - US_FC_B_OP_INCR: If we do jump, increment branch counter by 1 for inactive pixels. Deactivate pixels that decided not to jump and set their counter to zero.
IGNORE_UNCOVERED	28	0x0	If set, uncovered pixels will not participate in flow control decisions. <u>POSSIBLE VALUES:</u> 00 - Include uncovered pixels in jump decisions 01 - Ignore uncovered pixels in making jump decisions

US:US_FC_INT_CONST [0-31] · [R/W] · 32 bits · Access: 8/16/32 · MMReg:0x4c00-0x4c7c			
DESCRIPTION: Integer Constants used by Flow Control Loop Instructions. Single buffered.			
Field Name	Bits	Default	Description
KR	7:0	0x0	Specifies the number of iterations. Unsigned 8-bit integer in [0, 255].
KG	15:8	0x0	Specifies the initial value of the loop register (aL). Unsigned 8-bit integer in [0, 255].
KB	23:16	0x0	Specifies the increment used to change the loop register (aL) on each iteration. Signed 7-bit integer in [-128, 127].

US:US_FORMAT0 [0-15] · [R/W] · 32 bits · Access: 8/16/32 · MMReg:0x4640-0x467c			
Field Name	Bits	Default	Description
TXWIDTH	10:0	0x0	
TXHEIGHT	21:11	0x0	
TXDEPTH	25:22	0x0	<u>POSSIBLE VALUES:</u> 13 - width > 2048, height <= 2048 14 - width <= 2048, height > 2048 15 - width > 2048, height > 2048

US:US_OUT_FMT_[0-3] · [R/W] · 32 bits · Access: 8/16/32 · MMReg:0x46a4-0x46b0			
Field Name	Bits	Default	Description
OUT_FMT	4:0	0x0	<u>POSSIBLE VALUES:</u> 00 - C4_8 (S/U) 01 - C4_10 (U) 02 - C4_10_GAMMA - (U) 03 - C_16 - (S/U) 04 - C2_16 - (S/U) 05 - C4_16 - (S/U) 06 - C_16_MPEG - (S) 07 - C2_16_MPEG - (S) 08 - C2_4 - (U) 09 - C_3_3_2 - (U) 10 - C_6_5_6 - (S/U) 11 - C_11_11_10 - (S/U) 12 - C_10_11_11 - (S/U) 13 - C_2_10_10_10 - (S/U) 14 - reserved 15 - UNUSED - Render target is not used 16 - C_16_FP - (S10E5) 17 - C2_16_FP - (S10E5) 18 - C4_16_FP - (S10E5) 19 - C_32_FP - (S23E8) 20 - C2_32_FP - (S23E8) 21 - C4_32_FP - (S23E8)
C0_SEL	9:8	0x0	<u>POSSIBLE VALUES:</u> 00 - Alpha 01 - Red 02 - Green 03 - Blue
C1_SEL	11:10	0x0	<u>POSSIBLE VALUES:</u> 00 - Alpha 01 - Red 02 - Green 03 - Blue
C2_SEL	13:12	0x0	<u>POSSIBLE VALUES:</u> 00 - Alpha 01 - Red 02 - Green 03 - Blue
C3_SEL	15:14	0x0	<u>POSSIBLE VALUES:</u> 00 - Alpha 01 - Red 02 - Green 03 - Blue
OUT_SIGN	19:16	0x0	
ROUND_ADJ	20	0x0	<u>POSSIBLE VALUES:</u> 00 - Normal rounding 01 - Modified rounding of fixed-point data

US:US_PIXSIZE · [R/W] · 32 bits · Access: 8/16/32 · MMReg:0x4604			
DESCRIPTION: <i>Shader pixel size. This register specifies the size and partitioning of the current pixel stack frame</i>			
Field Name	Bits	Default	Description
PIX_SIZE	6:0	0x0	Specifies the total size of the current pixel stack frame (1:128)

US:US_TEX_ADDR [0-511] · [R/W] · 32 bits · Access: 8/16/32 · MMReg:0x9800-0x9ffc			
DESCRIPTION: <i>Texture addresses and swizzles</i>			
Field Name	Bits	Default	Description
SRC_ADDR	6:0	0x0	Specifies the location (within the shader pixel stack frame) of the texture address for this instruction
SRC_ADDR_REL	7	0x0	Specifies whether the loop register is added to the value of the associated address before it is used. This implements relative addressing. POSSIBLE VALUES: 00 - NONE: Do not modify source address 01 - RELATIVE: Add aL before lookup.
SRC_S_SWIZ	9:8	0x0	Specify which colour channel of src_addr to use for S coordinate POSSIBLE VALUES: 00 - Use R channel as S coordinate 01 - Use G channel as S coordinate 02 - Use B channel as S coordinate 03 - Use A channel as S coordinate
SRC_T_SWIZ	11:10	0x0	Specify which colour channel of src_addr to use for T coordinate POSSIBLE VALUES: 00 - Use R channel as T coordinate 01 - Use G channel as T coordinate 02 - Use B channel as T coordinate 03 - Use A channel as T coordinate
SRC_R_SWIZ	13:12	0x0	Specify which colour channel of src_addr to use for R coordinate POSSIBLE VALUES: 00 - Use R channel as R coordinate 01 - Use G channel as R coordinate 02 - Use B channel as R coordinate 03 - Use A channel as R coordinate
SRC_Q_SWIZ	15:14	0x0	Specify which colour channel of src_addr to use for Q coordinate POSSIBLE VALUES: 00 - Use R channel as Q coordinate

			01 - Use G channel as Q coordinate 02 - Use B channel as Q coordinate 03 - Use A channel as Q coordinate
DST_ADDR	22:16	0x0	Specifies the location (within the shader pixel stack frame) of the returned texture data for this instruction
DST_ADDR_REL	23	0x0	Specifies whether the loop register is added to the value of the associated address before it is used. This implements relative addressing. <u>POSSIBLE VALUES:</u> 00 - NONE: Do not modify destination address 01 - RELATIVE: Add aL before lookup.
DST_R_SWIZ	25:24	0x0	Specify which colour channel of the returned texture data to write to the red channel of dst_addr <u>POSSIBLE VALUES:</u> 00 - Write R channel to R channel 01 - Write G channel to R channel 02 - Write B channel to R channel 03 - Write A channel to R channel
DST_G_SWIZ	27:26	0x0	Specify which colour channel of the returned texture data to write to the green channel of dst_addr <u>POSSIBLE VALUES:</u> 00 - Write R channel to G channel 01 - Write G channel to G channel 02 - Write B channel to G channel 03 - Write A channel to G channel
DST_B_SWIZ	29:28	0x0	Specify which colour channel of the returned texture data to write to the blue channel of dst_addr <u>POSSIBLE VALUES:</u> 00 - Write R channel to B channel 01 - Write G channel to B channel 02 - Write B channel to B channel 03 - Write A channel to B channel
DST_A_SWIZ	31:30	0x0	Specify which colour channel of the returned texture data to write to the alpha channel of dst_addr <u>POSSIBLE VALUES:</u> 00 - Write R channel to A channel 01 - Write G channel to A channel 02 - Write B channel to A channel 03 - Write A channel to A channel

US:US_TEX_ADDR_DX DY [0-511] · [R/W] · 32 bits · Access: 8/16/32 · MMReg:0xa000-0xa7fc

DESCRIPTION: *Additional texture addresses and swizzles for DX/DY inputs*

Field Name	Bits	Default	Description
------------	------	---------	-------------

DX_ADDR	6:0	0x0	Specifies the location (within the shader pixel stack frame) of the DX value for this instruction
DX_ADDR_REL	7	0x0	Specifies whether the loop register is added to the value of the associated address before it is used. This implements relative addressing. <u>POSSIBLE VALUES:</u> 00 - NONE: Do not modify source address 01 - RELATIVE: Add aL before lookup.
DX_S_SWIZ	9:8	0x0	Specify which colour channel of dx_addr to use for S coordinate <u>POSSIBLE VALUES:</u> 00 - Use R channel as S coordinate 01 - Use G channel as S coordinate 02 - Use B channel as S coordinate 03 - Use A channel as S coordinate
DX_T_SWIZ	11:10	0x0	Specify which colour channel of dx_addr to use for T coordinate <u>POSSIBLE VALUES:</u> 00 - Use R channel as T coordinate 01 - Use G channel as T coordinate 02 - Use B channel as T coordinate 03 - Use A channel as T coordinate
DX_R_SWIZ	13:12	0x0	Specify which colour channel of dx_addr to use for R coordinate <u>POSSIBLE VALUES:</u> 00 - Use R channel as R coordinate 01 - Use G channel as R coordinate 02 - Use B channel as R coordinate 03 - Use A channel as R coordinate
DX_Q_SWIZ	15:14	0x0	Specify which colour channel of dx_addr to use for Q coordinate <u>POSSIBLE VALUES:</u> 00 - Use R channel as Q coordinate 01 - Use G channel as Q coordinate 02 - Use B channel as Q coordinate 03 - Use A channel as Q coordinate
DY_ADDR	22:16	0x0	Specifies the location (within the shader pixel stack frame) of the DY value for this instruction
DY_ADDR_REL	23	0x0	Specifies whether the loop register is added to the value of the associated address before it is used. This implements relative addressing. <u>POSSIBLE VALUES:</u> 00 - NONE: Do not modify source address

			01 - RELATIVE: Add aL before lookup.
DY_S_SWIZ	25:24	0x0	Specify which colour channel of dy_addr to use for S coordinate <u>POSSIBLE VALUES:</u> 00 - Use R channel as S coordinate 01 - Use G channel as S coordinate 02 - Use B channel as S coordinate 03 - Use A channel as S coordinate
DY_T_SWIZ	27:26	0x0	Specify which colour channel of dy_addr to use for T coordinate <u>POSSIBLE VALUES:</u> 00 - Use R channel as T coordinate 01 - Use G channel as T coordinate 02 - Use B channel as T coordinate 03 - Use A channel as T coordinate
DY_R_SWIZ	29:28	0x0	Specify which colour channel of dy_addr to use for R coordinate <u>POSSIBLE VALUES:</u> 00 - Use R channel as R coordinate 01 - Use G channel as R coordinate 02 - Use B channel as R coordinate 03 - Use A channel as R coordinate
DY_Q_SWIZ	31:30	0x0	Specify which colour channel of dy_addr to use for Q coordinate <u>POSSIBLE VALUES:</u> 00 - Use R channel as Q coordinate 01 - Use G channel as Q coordinate 02 - Use B channel as Q coordinate 03 - Use A channel as Q coordinate

US:US_TEX_INST_[0-511] · [R/W] · 32 bits · Access: 8/16/32 · MMReg:0x9000-0x97fc			
DESCRIPTION: <i>Texture Instruction</i>			
Field Name	Bits	Default	Description
TEX_ID	19:16	0x0	Specifies the id of the texture map used for this instruction
INST	24:22	0x0	Specifies the operation taking place for this instruction <u>POSSIBLE VALUES:</u> 00 - NOP: Do nothing 01 - LD: Do Texture Lookup (S,T,R) 02 - TEXKILL: Kill pixel if any component is < 0 03 - PROJ: Do projected texture lookup (S/Q,T/Q,R/Q) 04 - LODBIAS: Do texture lookup with lod bias

			05 - LOD: Do texture lookup with explicit lod 06 - DXDY: Do texture lookup with lod calculated from DX and DY
TEX_SEM_ACQUIRE	25	0x0	Whether to hold the texture semaphore until the data is written to the temporary register. <u>POSSIBLE VALUES:</u> 00 - Don't hold the texture semaphore 01 - Hold the texture semaphore until the data is written to the temporary register.
IGNORE_UNCOVERED	26	0x0	If set, US will not request data for pixels which are uncovered. Clear this bit for indirect texture lookups. <u>POSSIBLE VALUES:</u> 00 - Fetch texels for uncovered pixels 01 - Don't fetch texels for uncovered pixels
UNSCALED	27	0x0	Whether to scale texture coordinates when sending them to the texture unit. <u>POSSIBLE VALUES:</u> 00 - Scale the S, T, R texture coordinates from [0.0,1.0] to the dimensions of the target texture 01 - Use the unscaled S, T, R texture coordinates.

US:US_W_FMT · [R/W] · 32 bits · Access: 8/16/32 · MMReg:0x46b4			
DESCRIPTION: <i>Specifies the source and format for the Depth (W) value output by the shader</i>			
Field Name	Bits	Default	Description
W_FMT	1:0	0x0	Format for W <u>POSSIBLE VALUES:</u> 00 - W0 - W is always zero 01 - W24 - 24-bit fixed point 02 - W24_FP - 24-bit floating point. The floating point values are a special format that preserve sorting order when values are compared as integers, allowing higher precision in W without additional logic in other blocks. 03 - Reserved
W_SRC	2	0x0	Source for W <u>POSSIBLE VALUES:</u> 00 - WSRC_US - W comes from shader instruction 01 - WSRC_RAS - W comes from rasterizer

10.10 Vertex Registers

VAP:VAP_ALT_NUM_VERTICES · [R/W] · 32 bits · Access: 32 · MMReg:0x2088			
DESCRIPTION: Alternate Number of Vertices to allow > 16-bits of Vertex count			
Field Name	Bits	Default	Description
NUM_VERTICES	23:0	0x0	24-bit vertex count for command packet. Used instead of bits 31:16 of VAP_VF_CNTL if VAP_VF_CNTL.USE_ALT_NUM_VERTS is set.

VAP:VAP_CLIP_CNTL · [R/W] · 32 bits · Access: 32 · MMReg:0x221c			
DESCRIPTION: Control Bits for User Clip Planes and Clipping			
Field Name	Bits	Default	Description
UCP_ENA_0	0	0x0	Enable User Clip Plane 0
UCP_ENA_1	1	0x0	Enable User Clip Plane 1
UCP_ENA_2	2	0x0	Enable User Clip Plane 2
UCP_ENA_3	3	0x0	Enable User Clip Plane 3
UCP_ENA_4	4	0x0	Enable User Clip Plane 4
UCP_ENA_5	5	0x0	Enable User Clip Plane 5
PS_UCP_MODE	15:14	0x0	0 = Cull using distance from center of point 1 = Cull using radius-based distance from center of point 2 = Cull using radius-based distance from center of point, Expand and Clip on intersection 3 = Always expand and clip as trifan
CLIP_DISABLE	16	0x0	Disables clip code generation and clipping process for TCL
UCP_CULL_ONLY_ENA	17	0x0	Cull Primitives against UCPS, but don't clip
BOUNDARY_EDGE_FLAG_ENA	18	0x0	If set, boundary edges are highlighted, else they are not highlighted
COLOR2_IS_TEXTURE	20	0x0	If set, color2 is used as texture8 by GA (PS3.0 requirement)
COLOR3_IS_TEXTURE	21	0x0	If set, color3 is used as texture9 by GA (PS3.0 requirement)

VAP:VAP_CNTL · [R/W] · 32 bits · Access: 32 · MMReg:0x2080			
DESCRIPTION: Vertex Assembler/Processor Control Register			
Field Name	Bits	Default	Description
PVS_NUM_SLOTS	3:0	0x0	Specifies the number of vertex slots to be used in the VAP PVS process. A slot represents a single vertex storage location1 across multiple engines (one vertex per engine). By decreasing the number of slots, there is more memory for each vertex, but less parallel processing.

			Similarly, by increasing the number of slots, there is less memory per vertex but more vertices being processed in parallel.
PVS_NUM_CNTLRS	7:4	0x0	Specifies the maximum number of controllers to be processing in parallel. In general should be set to max value of TBD. Can be changed for performance analysis.
PVS_NUM_FPUS	11:8	0x0	Specifies the number of Floating Point Units (Vector/Math Engines) to use when processing vertices.
VAP_NO_RENDER	17	0x0	If set, VAP will not process any draw commands (i.e. writes to VAP_VF_CNTL, the INDX and DATAPORT and Immediate mode writes are ignored.
VF_MAX_VTX_NUM	21:18	0x9	This field controls the number of vertices that the vertex fetcher manages for the TCL and Setup Vertex Storage memories (and therefore the number of vertices that can be re-used). This value should be set to 12 for most operation, This number may be modified for performance evaluation. The value is the maximum vertex number used which is one less than the number of vertices (i.e. a 12 means 13 vertices will be used)
DX_CLIP_SPACE_DEF	22	0x0	Clip space is defined as: 0: $-W < X < W, -W < Y < W, -W < Z < W$ (OpenGL Definition) 1: $-W < X < W, -W < Y < W, 0 < Z < W$ (DirectX Definition)
TCL_STATE_OPTIMIZATION	23	0x0	If set, enables the TCL state optimization, and the new state is used only if there is a change in TCL state, between VF_CNTL (triggers)

VAP:VAP_CNTL_STATUS · [R/W] · 32 bits · Access: 32 · MMReg:0x2140			
DESCRIPTION: Vertex Assemblen/Processor Control Status			
Field Name	Bits	Default	Description
VC_SWAP	1:0	0x0	Endian-Swap Control. 0 = No swap 1 = 16-bit swap: 0xAABBCCDD becomes 0xBBAADDCC 2 = 32-bit swap: 0xAABBCCDD becomes 0xDDCCBBAA 3 = Half-dword swap: 0xAABBCCDD becomes 0xCCDDAABB Default = 0
PVS_BYPASS	8	0x0	The TCL engine is logically or physically removed from the circuit.
PVS_BUSY (Access: R)	11	0x0	Transform/Clip/Light (TCL) Engine is Busy. Read-only.
MAX_MPS (Access: R)	19:16	0x0	Maximum number of MPs fused for this chip. Read-only. For A11, fusemask is fixed to 1XXX. For A12,

			CG.CC_COMBINEDSTRAPS.MAX_MPS[7:5] = 000 => max_mps[3:0] = 1XXX => 8 MPs CG.CC_COMBINEDSTRAPS.MAX_MPS[7:5] = 001 => max_mps[3:0] = 0110 => 6 MPs CG.CC_COMBINEDSTRAPS.MAX_MPS[7:5] = 010 => max_mps[3:0] = 0101 => 5 MPs CG.CC_COMBINEDSTRAPS.MAX_MPS[7:5] = 011 => max_mps[3:0] = 0100 => 4 MPs CG.CC_COMBINEDSTRAPS.MAX_MPS[7:5] = 100 => max_mps[3:0] = 0011 => 3 MPs CG.CC_COMBINEDSTRAPS.MAX_MPS[7:5] = 101 => max_mps[3:0] = 0010 => 2 MPs CG.CC_COMBINEDSTRAPS.MAX_MPS[7:5] = 110 => max_mps[3:0] = 0001 => 1 MP CG.CC_COMBINEDSTRAPS.MAX_MPS[7:5] = 111 => max_mps[3:0] = 0000 => 0 MP Note that max_mps[3:0] = 0111 = 7 MPs is not available
VS_BUSY (Access: R)	24	0x0	Vertex Store is Busy. Read-only.
RCP_BUSY (Access: R)	25	0x0	Reciprocal Engine is Busy. Read-only.
VTE_BUSY (Access: R)	26	0x0	ViewPort Transform Engine is Busy. Read-only.
MIU_BUSY (Access: R)	27	0x0	Memory Interface Unit is Busy. Read-only.
VC_BUSY (Access: R)	28	0x0	Vertex Cache is Busy. Read-only.
VF_BUSY (Access: R)	29	0x0	Vertex Fetcher is Busy. Read-only.
REGPIPE_BUSY (Access: R)	30	0x0	Register Pipeline is Busy. Read-only.
VAP_BUSY (Access: R)	31	0x0	VAP Engine is Busy. Read-only.

VAP:VAP_GB_HORZ_CLIP_ADJ · [R/W] · 32 bits · Access: 32 · MMRReg:0x2228			
DESCRIPTION: <i>Horizontal Guard Band Clip Adjust Register</i>			
Field Name	Bits	Default	Description
DATA_REGISTER	31:0	0x0	32-bit floating point value. Should be set to 1.0 for no guard band.

VAP:VAP_GB_HORZ_DISC_ADJ · [R/W] · 32 bits · Access: 32 · MMRReg:0x222c			
DESCRIPTION: <i>Horizontal Guard Band Discard Adjust Register</i>			
Field Name	Bits	Default	Description
DATA_REGISTER	31:0	0x0	32-bit floating point value. Should be set to 1.0 for no guard band.

VAP:VAP_GB_VERT_CLIP_ADJ · [R/W] · 32 bits · Access: 32 · MMReg:0x2220			
DESCRIPTION: Vertical Guard Band Clip Adjust Register			
Field Name	Bits	Default	Description
DATA_REGISTER	31:0	0x0	32-bit floating point value. Should be set to 1.0 for no guard band.

VAP:VAP_GB_VERT_DISC_ADJ · [R/W] · 32 bits · Access: 32 · MMReg:0x2224			
DESCRIPTION: Vertical Guard Band Discard Adjust Register			
Field Name	Bits	Default	Description
DATA_REGISTER	31:0	0x0	32-bit floating point value. Should be set to 1.0 for no guard band.

VAP:VAP_INDEX_OFFSET · [R/W] · 32 bits · Access: 32 · MMReg:0x208c			
DESCRIPTION: Offset Value added to index value in both Indexed and Auto-indexed modes. Disabled by setting to 0			
Field Name	Bits	Default	Description
INDEX_OFFSET	24:0	0x0	25-bit signed 2's comp offset value

VAP:VAP_OUT_VTX_FMT_0 · [R/W] · 32 bits · Access: 32 · MMReg:0x2090			
DESCRIPTION: VAP Out/GA Vertex Format Register 0			
Field Name	Bits	Default	Description
VTX_POS_PRESENT	0	0x0	Output the Position Vector
VTX_COLOR_0_PRESENT	1	0x0	Output Color 0 Vector
VTX_COLOR_1_PRESENT	2	0x0	Output Color 1 Vector
VTX_COLOR_2_PRESENT	3	0x0	Output Color 2 Vector
VTX_COLOR_3_PRESENT	4	0x0	Output Color 3 Vector
VTX_PT_SIZE_PRESENT	16	0x0	Output Point Size Vector

VAP:VAP_OUT_VTX_FMT_1 · [R/W] · 32 bits · Access: 32 · MMReg:0x2094			
DESCRIPTION: VAP Out/GA Vertex Format Register 1			
Field Name	Bits	Default	Description
TEX_0_COMP_CNT	2:0	0x0	Number of words in texture 0 = Not Present 1 = 1 component 2 = 2 components 3 = 3 components 4 = 4 components

TEX_1_COMP_CNT	5:3	0x0	Number of words in texture 0 = Not Present 1 = 1 component 2 = 2 components 3 = 3 components 4 = 4 components
TEX_2_COMP_CNT	8:6	0x0	Number of words in texture 0 = Not Present 1 = 1 component 2 = 2 components 3 = 3 components 4 = 4 components
TEX_3_COMP_CNT	11:9	0x0	Number of words in texture 0 = Not Present 1 = 1 component 2 = 2 components 3 = 3 components 4 = 4 components
TEX_4_COMP_CNT	14:12	0x0	Number of words in texture 0 = Not Present 1 = 1 component 2 = 2 components 3 = 3 components 4 = 4 components
TEX_5_COMP_CNT	17:15	0x0	Number of words in texture 0 = Not Present 1 = 1 component 2 = 2 components 3 = 3 components 4 = 4 components
TEX_6_COMP_CNT	20:18	0x0	Number of words in texture 0 = Not Present 1 = 1 component 2 = 2 components 3 = 3 components 4 = 4 components
TEX_7_COMP_CNT	23:21	0x0	Number of words in texture 0 = Not Present 1 = 1 component 2 = 2 components 3 = 3 components 4 = 4 components

VAP:VAP_PORT_DATA[0-15] · [W] · 32 bits · Access: 32 · MMRReg:0x2000-0x203c			
DESCRIPTION: Setup Engine Data Port 0 through 15.			
Field Name	Bits	Default	Description
DATAPORT0 (master with mirrors)	31:0	0x0	1st of 16 consecutive dwords for writing vertex data information.

			Write-only.
--	--	--	-------------

VAP:VAP_PORT_DATA_IDX_128 · [W] · 32 bits · Access: 32 · MMReg:0x20b8			
DESCRIPTION: 128-bit Data Port for Indexed Primitives.			
Field Name	Bits	Default	Description
DATA_IDX_PORT_128	31:0	0x0	128-bit Data Port for Indexed Primitives. Write-only.

VAP:VAP_PORT_IDX[0-15] · [W] · 32 bits · Access: 32 · MMReg:0x2040-0x207c			
DESCRIPTION: Setup Engine Index Port 0 through 15.			
Field Name	Bits	Default	Description
IDXPORT0 (master with mirrors)	31:0	0x0	1st of 16 consecutive dwords for writing vertex index information, in the format of: 15:0 Index 0 31:16 Index 1 Write-only.

VAP:VAP_PROG_STREAM_CNTL_[0-7] · [R/W] · 32 bits · Access: 32 · MMReg:0x2150-0x216c			
DESCRIPTION: Programmable Stream Control Word 0			
Field Name	Bits	Default	Description
DATA_TYPE_0	3:0	0x0	The data type for element 0 0 = FLOAT_1 (Single IEEE Float) 1 = FLOAT_2 (2 IEEE floats) 2 = FLOAT_3 (3 IEEE Floats) 3 = FLOAT_4 (4 IEEE Floats) 4 = BYTE * (1 DWORD w 4 8-bit fixed point values) (X = [7:0], Y = [15:8], Z = [23:16], W = [31:24]) 5 = D3DCOLOR * (Same as BYTE except has X->Z,Z->X swap for D3D color def) (Z = [7:0], Y = [15:8], X = [23:16], W = [31:24]) 6 = SHORT_2 * (1 DWORD with 2 16-bit fixed point values) (X = [15:0], Y = [31:16], Z = 0.0, W = 1.0) 7 = SHORT_4 * (2 DWORDS with 4(2 per dword) 16-bit fixed point values) (X = DW0 [15:0], Y = DW0 [31:16], Z = DW1 [15:0], W = DW1 [31:16]) 8 = VECTOR_3_TTT * (1 DWORD with 3 10-bit fixed point values) (X = [9:0], Y = [19:10], Z = [29:20], W = 1.0) 9 = VECTOR_3_EET * (1 DWORD with 2 11-bit and 1 10-bit fixed point values) (X = [10:0], Y = [21:11], Z = [31:22], W = 1.0) 10 = FLOAT_8 (8 IEEE Floats) Sames as 2 FLOAT_4 but must use consecutive

			DST_VEC_LOC. Used to allow > 16 PSC for OGL path. 11 = FLT16_2 (1 DWORD with 2 16-bit floating point values (SE5M10 exp bias of 15, supports denormalized numbers)) (X = [15:0], Y = [31:16], Z = 0.0, W = 1.0) 12 = FLT16_4 (2 DWORDS with 4(2 per dword) 16-bit floating point values (SE5M10 exp bias of 15, supports denormalized numbers)) (X = DW0 [15:0], Y = DW0 [31:16], Z = DW1 [15:0], W = DW1 [31:16]) * These data types use the SIGNED and NORMALIZE flags described below.
SKIP_DWORDS_0	7:4	0x0	The number of DWORDS to skip (discard) after processing the current element.
DST_VEC_LOC_0	12:8	0x0	The vector address in the input memory to write this element
LAST_VEC_0	13	0x0	If set, indicates the last vector of the current vertex stream
SIGNED_0	14	0x0	Determines whether fixed point data types are unsigned (0) or 2's complement signed (1) data types. See NORMALIZE for complete description of affect
NORMALIZE_0	15	0x0	Determines whether the fixed to floating point conversion will normalize the value (i.e. fixed point value is all fractional bits) or not (i.e. fixed point value is all integer bits). This table describes the fixed to float conversion results SIGNED NORMALIZE FLT RANGE 0 0 0.0 - (2 ⁿ - 1) (i.e. 8-bit -> 0.0 - 255.0) 0 1 0.0 - 1.0 1 0 -2 ⁽ⁿ⁻¹⁾ - (2 ⁽ⁿ⁻¹⁾ - 1) (i.e. 8-bit -> -128.0 - 127.0) 1 1 -1.0 - 1.0 where n is the number of bits in the associated fixed point value For signed, normalize conversion, since the fixed point range is not evenly distributed around 0, there are 3 different methods supported by R300. See the VAP_PSC_SGN_NORM_CNTL description for details.
DATA_TYPE_1	19:16	0x0	Similar to DATA_TYPE_0
SKIP_DWORDS_1	23:20	0x0	See SKIP_DWORDS_0
DST_VEC_LOC_1	28:24	0x0	See DST_VEC_LOC_0
LAST_VEC_1	29	0x0	See LAST_VEC_0
SIGNED_1	30	0x0	See SIGNED_0
NORMALIZE_1	31	0x0	See NORMALIZE_0

VAP:VAP_PROG_STREAM_CNTL_EXT [0-7] · [R/W] · 32 bits · Access: 32 · MMRReg:0x21e0-0x21fc			
DESCRIPTION: <i>Programmable Stream Control Extension Word 0</i>			
Field Name	Bits	Default	Description

SWIZZLE_SELECT_X_0	2:0	0x0	X-Component Swizzle Select 0 = SELECT_X 1 = SELECT_Y 2 = SELECT_Z 3 = SELECT_W 4 = SELECT_FP_ZERO (Floating Point 0.0) 5 = SELECT_FP_ONE (Floating Point 1.0) 6,7 RESERVED
SWIZZLE_SELECT_Y_0	5:3	0x0	Y-Component Swizzle Select (See Above)
SWIZZLE_SELECT_Z_0	8:6	0x0	Z-Component Swizzle Select (See Above)
SWIZZLE_SELECT_W_0	11:9	0x0	W-Component Swizzle Select (See Above)
WRITE_ENA_0	15:12	0x0	4-bit write enable. Bit 0 maps to X Bit 1 maps to Y Bit 2 maps to Z Bit 3 maps to W
SWIZZLE_SELECT_X_1	18:16	0x0	See SWIZZLE_SELECT_X_0
SWIZZLE_SELECT_Y_1	21:19	0x0	See SWIZZLE_SELECT_Y_0
SWIZZLE_SELECT_Z_1	24:22	0x0	See SWIZZLE_SELECT_Z_0
SWIZZLE_SELECT_W_1	27:25	0x0	See SWIZZLE_SELECT_W_0
WRITE_ENA_1	31:28	0x0	See WRITE_ENA_0

VAP:VAP_PSC_SGN_NORM_CNTL · [R/W] · 32 bits · Access: 32 · MMReg:0x21dc			
DESCRIPTION: Programmable Stream Control Signed Normalize Control			
Field Name	Bits	Default	Description
SGN_NORM_METHOD_0	1:0	0x0	There are 3 methods of normalizing signed numbers: 0: SGN_NORM_ZERO : value / (2 ⁽ⁿ⁻¹⁾ -1), so -128/127 will be less than -1.0, -127/127 will yield -1.0, 0/127 will yield 0, and 127/127 will yield 1.0 for 8-bit numbers. 1: SGN_NORM_ZERO_CLAMP_MINUS_ONE: Same as SGN_NORM_ZERO except -128/127 will yield -1.0 for 8-bit numbers. 2: SGN_NORM_NO_ZERO: (2 * value + 1)/2 ⁿ , so -128 will yield -255/255 = -1.0, 127 will yield 255/255 = 1.0, but 0 will yield 1/255 != 0.
SGN_NORM_METHOD_1	3:2	0x0	See SGN_NORM_METHOD_0
SGN_NORM_METHOD_2	5:4	0x0	See SGN_NORM_METHOD_0
SGN_NORM_METHOD_3	7:6	0x0	See SGN_NORM_METHOD_0
SGN_NORM_METHOD_4	9:8	0x0	See SGN_NORM_METHOD_0
SGN_NORM_METHOD_5	11:10	0x0	See SGN_NORM_METHOD_0
SGN_NORM_METHOD_6	13:12	0x0	See SGN_NORM_METHOD_0
SGN_NORM_METHOD_7	15:14	0x0	See SGN_NORM_METHOD_0
SGN_NORM_METHOD_8	17:16	0x0	See SGN_NORM_METHOD_0

SGN_NORM_METHOD_9	19:18	0x0	See SGN_NORM_METHOD_0
SGN_NORM_METHOD_10	21:20	0x0	See SGN_NORM_METHOD_0
SGN_NORM_METHOD_11	23:22	0x0	See SGN_NORM_METHOD_0
SGN_NORM_METHOD_12	25:24	0x0	See SGN_NORM_METHOD_0
SGN_NORM_METHOD_13	27:26	0x0	See SGN_NORM_METHOD_0
SGN_NORM_METHOD_14	29:28	0x0	See SGN_NORM_METHOD_0
SGN_NORM_METHOD_15	31:30	0x0	See SGN_NORM_METHOD_0

VAP:VAP_PVS_CODE_CNTL_0 · [R/W] · 32 bits · Access: 32 · MMReg:0x22d0			
DESCRIPTION: Programmable Vertex Shader Code Control Register 0			
Field Name	Bits	Default	Description
PVS_FIRST_INST	9:0	0x0	First Instruction to Execute in PVS.
PVS_XYZW_VALID_INST	19:10	0x0	The PVS Instruction which updates the clip coordinate position for the last time. This value is used to lower the processing priority while trivial clip and back-face culling decisions are made. This field must be set to valid instruction.
PVS_LAST_INST	29:20	0x0	Last Instruction (Inclusive) for the PVS to execute.

VAP:VAP_PVS_CODE_CNTL_1 · [R/W] · 32 bits · Access: 32 · MMReg:0x22d8			
DESCRIPTION: Programmable Vertex Shader Code Control Register 1			
Field Name	Bits	Default	Description
PVS_LAST_VTX_SRC_INST	9:0	0x0	The PVS Instruction which uses the Input Vertex Memory for the last time. This value is used to free up the Input Vertex Slots ASAP. This field must be set to a valid instruction.

VAP:VAP_PVS_CONST_CNTL · [R/W] · 32 bits · Access: 32 · MMReg:0x22d4			
DESCRIPTION: Programmable Vertex Shader Constant Control Register			
Field Name	Bits	Default	Description
PVS_CONST_BASE_OFFSET	7:0	0x0	Vector Offset into PVS constant memory to the start of the constants for the current shader
PVS_MAX_CONST_ADDR	23:16	0x0	The maximum constant address which should be generated by the shader (Inst Const Addr + Addr Register). If the address which is generated by the shader is outside the range of 0 to PVS_MAX_CONST_ADDR, then (0,0,0,0) is returned as the source operand data.

VAP:VAP_PVS_FLOW_CNTL_ADDRS [0-15] · [R/W] · 32 bits · Access: 32 · MMReg:0x2230-0x226c			
DESCRIPTION: Programmable Vertex Shader Flow Control Addresses Register 0			

Field Name	Bits	Default	Description
PVS_FC_ACT_ADRS_0	7:0	0x0	This field defines the last PVS instruction to execute prior to the control flow redirection. JUMP - The last instruction executed prior to the jump LOOP - The last instruction executed prior to the loop (init loop counter/inc) JSR - The last instruction executed prior to the jump to the subroutine.
PVS_FC_LOOP_CNT_JMP_INST_0	15:8	0x0	This field has multiple definitions as follows: JUMP - The instruction address to jump to. LOOP - The loop count. *Note loop count of 0 must be replaced by a jump. JSR - The instruction address to jump to (first inst of subroutine).
PVS_FC_LAST_INST_0	23:16	0x0	This field has multiple definitions as follows: JUMP - Not Applicable LOOP - The last instruction of the loop. JSR - The last instruction of the subroutine.
PVS_FC_RTN_INST_0	31:24	0x0	This field has multiple definitions as follows: JUMP - Not Applicable LOOP - First Instruction of Loop (Typically ACT_ADRS + 1) JSR - First Instruction After JSR (Typically ACT_ADRS + 1)

VAP:VAP_PVS_FLOW_CNTL_ADDRS_LW [0-15] · [R/W] · 32 bits · Access: 32 · MMRReg:0x2500-0x2578			
DESCRIPTION: For VS3.0 - To support more PVS instructions, increase the address range - Programmable Vertex Shader Flow Control Lower Word Addresses Register 0			
Field Name	Bits	Default	Description
PVS_FC_ACT_ADRS_0	15:0	0x0	This field defines the last PVS instruction to execute prior to the control flow redirection. JUMP - The last instruction executed prior to the jump LOOP - The last instruction executed prior to the loop (init loop counter/inc) JSR - The last instruction executed prior to the jump to the subroutine. (Addrss_Range:1K=[9:0];512=[8:0];256=[7:0])
PVS_FC_LOOP_CNT_JMP_INST_0	31:16	0x0	This field has multiple definitions as follows: JUMP - The instruction address to jump to. LOOP - The loop count. *Note loop count of 0 must be replaced by a jump. JSR - The instruction address to jump to (first inst of subroutine). (Addrss_Range:1K=[24:15];512=[23:15];256=[22:15])

VAP:VAP_PVS_FLOW_CNTL_ADDRS_UW [0-15] · [R/W] · 32 bits · Access: 32 · MMRReg:0x2504-			
--	--	--	--

0x257c			
DESCRIPTION: For VS3.0 - To support more PVS instructions, increase the address range - Programmable Vertex Shader Flow Control Upper Word Addresses Register 0			
Field Name	Bits	Default	Description
PVS_FC_LAST_INST_0	15:0	0x0	This field has multiple definitions as follows: JUMP - Not Applicable LOOP - The last instruction of the loop. JSR - The last instruction of the subroutine. (Addrss_Range: 1K=[9:0];512=[8:0];256=[7:0])
PVS_FC_RTN_INST_0	31:16	0x0	This field has multiple definitions as follows: JUMP - Not Applicable LOOP - First Instruction of Loop (Typically ACT_ADRS + 1) JSR - First Instruction After JSR (Typically ACT_ADRS + 1). (Addrss_Range: 1K=[24:15];512=[23:15];256=[22:15])

VAP:VAP_PVS_FLOW_CNTL_LOOP_INDEX [0-15] · [R/W] · 32 bits · Access: 32 · MMReg:0x2290-0x22cc			
DESCRIPTION: Programmable Vertex Shader Flow Control Loop Index Register 0			
Field Name	Bits	Default	Description
PVS_FC_LOOP_INIT_VAL_0	7:0	0x0	This field stores the automatic loop index register init value. This is an 8-bit unsigned value 0-255. This field is only used if the corresponding control flow instruction is a loop.
PVS_FC_LOOP_STEP_VAL_0	15:8	0x0	This field stores the automatic loop index register step value. This is an 8-bit 2's comp signed value -128-127. This field is only used if the corresponding control flow instruction is a loop.
PVS_FC_LOOP_REPEAT_NO_FLI_0	31	0x0	When this field is set, the automatic loop index register init value is not used at loop activation. The initial loop index is inherited from outer loop. The loop index register step value is used at the end of each loop iteration ; after loop completion, the outer loop index register is restored

VAP:VAP_PVS_FLOW_CNTL_OPC · [R/W] · 32 bits · Access: 32 · MMReg:0x22dc			
DESCRIPTION: Programmable Vertex Shader Flow Control Opcode Register			
Field Name	Bits	Default	Description
PVS_FC_OPC_0	1:0	0x0	This opcode field determines what type of control flow instruction to execute. 0 = NO_OP 1 = JUMP 2 = LOOP 3 = JSR (Jump to Subroutine)

PVS_FC_OPC_1	3:2	0x0	See PVS_FC_OPC_0.
PVS_FC_OPC_2	5:4	0x0	See PVS_FC_OPC_0.
PVS_FC_OPC_3	7:6	0x0	See PVS_FC_OPC_0.
PVS_FC_OPC_4	9:8	0x0	See PVS_FC_OPC_0.
PVS_FC_OPC_5	11:10	0x0	See PVS_FC_OPC_0.
PVS_FC_OPC_6	13:12	0x0	See PVS_FC_OPC_0.
PVS_FC_OPC_7	15:14	0x0	See PVS_FC_OPC_0.
PVS_FC_OPC_8	17:16	0x0	See PVS_FC_OPC_0.
PVS_FC_OPC_9	19:18	0x0	See PVS_FC_OPC_0.
PVS_FC_OPC_10	21:20	0x0	See PVS_FC_OPC_0.
PVS_FC_OPC_11	23:22	0x0	See PVS_FC_OPC_0.
PVS_FC_OPC_12	25:24	0x0	See PVS_FC_OPC_0.
PVS_FC_OPC_13	27:26	0x0	See PVS_FC_OPC_0.
PVS_FC_OPC_14	29:28	0x0	See PVS_FC_OPC_0.
PVS_FC_OPC_15	31:30	0x0	See PVS_FC_OPC_0.

VAP:VAP_PVS_STATE_FLUSH_REG · [R/W] · 32 bits · Access: 32 · MMReg:0x2284			
Field Name	Bits	Default	Description
DATA_REGISTER (Access: W)	31:0	0x0	This register is used to force a flush of the PVS block when single-buffered updates are performed. The multi-state control of PVS Code and Const memories by the driver is primarily for more flexible PVS state control and for performance testing. When this register address is written, the State Block will force a flush of PVS processing so that both versions of PVS state are available before updates are processed. This register is write only, and the data that is written is unused.

VAP:VAP_PVS_VECTOR_DATA_REG · [R/W] · 32 bits · Access: 32 · MMReg:0x2204			
Field Name	Bits	Default	Description
DATA_REGISTER	31:0	0x0	32-bit data to write to Vector Memory. Used for PVS code and Constant updates.

VAP:VAP_PVS_VECTOR_DATA_REG_128 · [W] · 32 bits · Access: 32 · MMReg:0x2208			
Field Name	Bits	Default	Description
DATA_REGISTER	31:0	0x0	128-bit data path to write to Vector Memory. Used for PVS code and Constant updates.

VAP:VAP_PVS_VECTOR_INDX_REG · [R/W] · 32 bits · Access: 32 · MMReg:0x2200			
---	--	--	--

Field Name	Bits	Default	Description
OCTWORD_OFFSET	10:0	0x0	Octword offset to begin writing.

VAP:VAP_PVS_VTX_TIMEOUT_REG · [R/W] · 32 bits · Access: 32 · MMReg:0x2288			
Field Name	Bits	Default	Description
CLK_COUNT	31:0	0xFFFFFFFF	This register is used to define the number of core clocks to wait for a vertex to be received by the VAP input controller (while the primitive path is backed up) before forcing any accumulated vertices to be submitted to the vertex processing path.

VAP:VAP_TEX_TO_COLOR_CNTL · [R/W] · 32 bits · Access: 32 · MMReg:0x2218			
DESCRIPTION: For VS3.0 color2texture - flat shading on textures - limitation: only first 8 vectors can have clipping with wrap shortest or point sprite generated textures			
Field Name	Bits	Default	Description
TEX_RGB_SHADE_FUNC_0	0	0x0	Default = 0
TEX_ALPHA_SHADE_FUNC_0	1	0x0	Default = 0
TEX_RGBA_CLAMP_0	2	0x0	Default = 0
TEX_RGB_SHADE_FUNC_1	4	0x0	Default = 0
TEX_ALPHA_SHADE_FUNC_1	5	0x0	Default = 0
TEX_RGBA_CLAMP_1	6	0x0	Default = 0
TEX_RGB_SHADE_FUNC_2	8	0x0	Default = 0
TEX_ALPHA_SHADE_FUNC_2	9	0x0	Default = 0
TEX_RGBA_CLAMP_2	10	0x0	Default = 0
TEX_RGB_SHADE_FUNC_3	12	0x0	Default = 0
TEX_ALPHA_SHADE_FUNC_3	13	0x0	Default = 0
TEX_RGBA_CLAMP_3	14	0x0	Default = 0
TEX_RGB_SHADE_FUNC_4	16	0x0	Default = 0
TEX_ALPHA_SHADE_FUNC_4	17	0x0	Default = 0

TEX_RGBA_CLAMP_4	18	0x0	Default = 0
TEX_RGB_SHADE_FUNC_5	20	0x0	Default = 0
TEX_ALPHA_SHADE_FUNC_5	21	0x0	Default = 0
TEX_RGBA_CLAMP_5	22	0x0	Default = 0
TEX_RGB_SHADE_FUNC_6	24	0x0	Default = 0
TEX_ALPHA_SHADE_FUNC_6	25	0x0	Default = 0
TEX_RGBA_CLAMP_6	26	0x0	Default = 0
TEX_RGB_SHADE_FUNC_7	28	0x0	Default = 0
TEX_ALPHA_SHADE_FUNC_7	29	0x0	Default = 0
TEX_RGBA_CLAMP_7	30	0x0	Default = 0

VAP:VAP_VF_CNTL · [R/W] · 32 bits · Access: 32 · MMRReg:0x2084			
DESCRIPTION: <i>Vertex Fetcher Control</i>			
Field Name	Bits	Default	Description
PRIM_TYPE	3:0	0x0	Primitive Type 0 : None (will not trigger Setup Engine to run) 1 : Point List 2 : Line List 3 : Line Strip 4 : Triangle List 5 : Triangle Fan 6 : Triangle Strip 7 : Triangle with wFlags (aka, Rage128 `Type-2` triangles) * 8-11 : Unused 12 : Line Loop 13 : Quad List 14 : Quad Strip 15 : Polygon *Encoding 7 indicates whether a 16-bit word of wFlags is present in the stream of indices arriving when the VTX_AMODE is programmed as a `0`. The Setup Engine just steps over the wFlags word; ignoring it. 0 = Stream contains just indices, as: [Index1, Index0] [Index3, Index2] [Index5, Index4]

			etc... 1 = Stream contains indices and wFlags: [Index1, Index0] [wFlags, Index 2] [Index4, Index3] [wFlags, Index5] etc...
PRIM_WALK	5:4	0x0	Method of Passing Vertex Data. 0 : State-Based Vertex Data. (Vertex data and tokens embedded in command stream.) 1 = Indexes (Indices embedded in command stream; vertex data to be fetched from memory.) 2 = Vertex List (Vertex data to be fetched from memory.) 3 = Vertex Data (Vertex data embedded in command stream.)
RSVD_PREV_USED	10:6	0x0	Reserved bits
INDEX_SIZE	11	0x0	When set, vertex indices are 32-bits/indx, otherwise, 16-bits/indx.
VTX_REUSE_DIS	12	0x0	When set, vertex reuse is disabled. DO NOT SET unless PRIM_WALK is Indexes.
DUAL_INDEX_MODE	13	0x0	When set, the incoming index is treated as two separate indices. Bits 23-16 are used as the index for AOS 0 (These are 0 for 16-bit indices) Bits 15-0 are used as the index for AOS 1-15. This mode was added specifically for HOS usage
USE_ALT_NUM_VERTS	14	0x0	When set, the number of vertices in the command packet is taken from VAP_ALT_NUM_VERTICES register instead of bits 31:16 of VAP_VF_CNTL
NUM_VERTICES	31:16	0x0	Number of vertices in the command packet.

VAP:VAP_VF_MAX_VTX_INDX · [R/W] · 32 bits · Access: 32 · MMReg:0x2134			
DESCRIPTION: <i>Maximum Vertex Indx Clamp</i>			
Field Name	Bits	Default	Description
MAX_INDX	23:0	0xFFFFFFFF	If index to be fetched is larger than this value, the fetch indx is set to MAX_INDX

VAP:VAP_VF_MIN_VTX_INDX · [R/W] · 32 bits · Access: 32 · MMReg:0x2138			
DESCRIPTION: <i>Minimum Vertex Indx Clamp</i>			
Field Name	Bits	Default	Description
MIN_INDX	23:0	0x0	If index to be fetched is smaller than this value, the fetch indx is set to MIN_INDX

VAP:VAP_VPORT_XOFFSET · [R/W] · 32 bits · Access: 32 · MMReg:0x1d9c, MMReg:0x209c			
--	--	--	--

DESCRIPTION: <i>Viewport Transform X Offset</i>			
Field Name	Bits	Default	Description
VPORT_XOFFSET	31:0	0x0	Viewport Offset for X coordinates. An IEEE float.

VAP:VAP_VPORT_XSCALE · [R/W] · 32 bits · Access: 32 · MMReg:0x1d98, MMReg:0x2098			
DESCRIPTION: <i>Viewport Transform X Scale Factor</i>			
Field Name	Bits	Default	Description
VPORT_XSCALE	31:0	0x0	Viewport Scale Factor for X coordinates. An IEEE float.

VAP:VAP_VPORT_YOFFSET · [R/W] · 32 bits · Access: 32 · MMReg:0x1da4, MMReg:0x20a4			
DESCRIPTION: <i>Viewport Transform Y Offset</i>			
Field Name	Bits	Default	Description
VPORT_YOFFSET	31:0	0x0	Viewport Offset for Y coordinates. An IEEE float.

VAP:VAP_VPORT_YSCALE · [R/W] · 32 bits · Access: 32 · MMReg:0x1da0, MMReg:0x20a0			
DESCRIPTION: <i>Viewport Transform Y Scale Factor</i>			
Field Name	Bits	Default	Description
VPORT_YSCALE	31:0	0x0	Viewport Scale Factor for Y coordinates. An IEEE float.

VAP:VAP_VPORT_ZOFFSET · [R/W] · 32 bits · Access: 32 · MMReg:0x1dac, MMReg:0x20ac			
DESCRIPTION: <i>Viewport Transform Z Offset</i>			
Field Name	Bits	Default	Description
VPORT_ZOFFSET	31:0	0x0	Viewport Offset for Z coordinates. An IEEE float.

VAP:VAP_VPORT_ZSCALE · [R/W] · 32 bits · Access: 32 · MMReg:0x1da8, MMReg:0x20a8			
DESCRIPTION: <i>Viewport Transform Z Scale Factor</i>			
Field Name	Bits	Default	Description
VPORT_ZSCALE	31:0	0x0	Viewport Scale Factor for Z coordinates. An IEEE float.

VAP:VAP_VTE_CNTL · [R/W] · 32 bits · Access: 32 · MMReg:0x20b0			
DESCRIPTION: <i>Viewport Transform Engine Control</i>			
Field Name	Bits	Default	Description
VPORT_X_SCALE_ENA	0	0x0	Viewport Transform Scale Enable for X component
VPORT_X_OFFSET_ENA	1	0x0	Viewport Transform Offset Enable for X component
VPORT_Y_SCALE_ENA	2	0x0	Viewport Transform Scale Enable for Y component
VPORT_Y_OFFSET_ENA	3	0x0	Viewport Transform Offset Enable for Y component

VPORT_Z_SCALE_ENA	4	0x0	Viewport Transform Scale Enable for Z component
VPORT_Z_OFFSET_ENA	5	0x0	Viewport Transform Offset Enable for Z component
VTX_XY_FMT	8	0x0	Indicates that the incoming X, Y have already been multiplied by 1/W0. If OFF, the Setup Engine will multiply the X, Y coordinates by 1/W0.,
VTX_Z_FMT	9	0x0	Indicates that the incoming Z has already been multiplied by 1/W0. If OFF, the Setup Engine will multiply the Z coordinate by 1/W0.
VTX_W0_FMT	10	0x0	Indicates that the incoming W0 is not 1/W0. If ON, the Setup Engine will perform the reciprocal to get 1/W0.
SERIAL_PROC_ENA	11	0x0	If set, x,y,z viewport transform are performed serially through a single pipeline instead of in parallel. Used to mimic RL300 design.

VAP:VAP_VTX_AOS_ADDR[0-15] · [R/W] · 32 bits · Access: 32 · MMReg:0x20c8-0x2120			
DESCRIPTION: <i>Array-of-Structures Address 0</i>			
Field Name	Bits	Default	Description
VTX_AOS_ADDR0	31:2	0x0	Base Address of the Array of Structures.

VAP:VAP_VTX_AOS_ATTR[01-1415] · [R/W] · 32 bits · Access: 32 · MMReg:0x20c4-0x2118			
DESCRIPTION: <i>Array-of-Structures Attributes 0 & 1</i>			
Field Name	Bits	Default	Description
VTX_AOS_COUNT0	6:0	0x0	Number of dwords in this structure.
VTX_AOS_STRIDE0	14:8	0x0	Number of dwords from one array element to the next.
VTX_AOS_COUNT1	22:16	0x0	Number of dwords in this structure.
VTX_AOS_STRIDE1	30:24	0x0	Number of dwords from one array element to the next.

VAP:VAP_VTX_NUM_ARRAYS · [R/W] · 32 bits · Access: 32 · MMReg:0x20c0			
DESCRIPTION: <i>Vertex Array of Structures Control</i>			
Field Name	Bits	Default	Description
VTX_NUM_ARRAYS	4:0	0x0	The number of arrays required to represent the current vertex type. Each Array is described by the following three fields: VTX_AOS_ADDR, VTX_AOS_COUNT, VTX_AOS_STRIDE.
VC_FORCE_PREFETCH	5	0x0	Force Vertex Data Pre-fetching. If this bit is set, then a 256-bit word will always be fetched, regardless of which dwords are needed. Typically useful when VAP_VF_CNTL.PRIM_WALK is set to Vertex List

			(Auto-incremented indices).
VC_DIS_CACHE_INVLD (Access: R)	6	0x0	If set, the vertex cache is not invalidated between draw packets. This allows vertex cache hits to occur from packet to packet. This must be set with caution with respect to multiple contexts in the driver.
AOS_0_FETCH_SIZE	16	0x0	Granule Size to Fetch for AOS 0. 0 = 128-bit granule size 1 = 256-bit granule size This allows the driver to program the fetch size based on DWORDS/VTX/AOS combined with AGP vs. LOC Memory. The general belief is that the granule size should always be 256-bits for LOC memory and AGP8X data, but should be 128-bit for AGP2X/4X data if the DWORDS/VTX/AOS is less than TBD (128?) bits.
AOS_1_FETCH_SIZE	17	0x0	See AOS_0_FETCH_SIZE
AOS_2_FETCH_SIZE	18	0x0	See AOS_0_FETCH_SIZE
AOS_3_FETCH_SIZE	19	0x0	See AOS_0_FETCH_SIZE
AOS_4_FETCH_SIZE	20	0x0	See AOS_0_FETCH_SIZE
AOS_5_FETCH_SIZE	21	0x0	See AOS_0_FETCH_SIZE
AOS_6_FETCH_SIZE	22	0x0	See AOS_0_FETCH_SIZE
AOS_7_FETCH_SIZE	23	0x0	See AOS_0_FETCH_SIZE
AOS_8_FETCH_SIZE	24	0x0	See AOS_0_FETCH_SIZE
AOS_9_FETCH_SIZE	25	0x0	See AOS_0_FETCH_SIZE
AOS_10_FETCH_SIZE	26	0x0	See AOS_0_FETCH_SIZE
AOS_11_FETCH_SIZE	27	0x0	See AOS_0_FETCH_SIZE
AOS_12_FETCH_SIZE	28	0x0	See AOS_0_FETCH_SIZE
AOS_13_FETCH_SIZE	29	0x0	See AOS_0_FETCH_SIZE
AOS_14_FETCH_SIZE	30	0x0	See AOS_0_FETCH_SIZE
AOS_15_FETCH_SIZE	31	0x0	See AOS_0_FETCH_SIZE

VAP:VAP_VTX_SIZE · [R/W] · 32 bits · Access: 32 · MMReg:0x20b4			
DESCRIPTION: <i>Vertex Size Specification Register</i>			
Field Name	Bits	Default	Description
DWORDS_PER_VTX	6:0	0x0	This field specifies the number of DWORDS per vertex to expect when VAP_VF_CNTL.PRIM_WALK is set to Vertex Data (vertex data embedded in command stream). This field is not used for any other PRIM_WALK settings. This field replaces the usage of the VAP_VTX_FMT_0/1 for this purpose in prior implementations.

VAP:VAP_VTX_STATE_CNTL · [R/W] · 32 bits · Access: 32 · MMReg:0x2180			
DESCRIPTION: <i>VAP Vertex State Control Register</i>			

Field Name	Bits	Default	Description
COLOR_0_ASSEMBLY_CNTL	1:0	0x0	0 : Select Color 0 1 : Select User Color 0 2 : Select User Color 1 3 : Reserved
COLOR_1_ASSEMBLY_CNTL	3:2	0x0	0 : Select Color 1 1 : Select User Color 0 2 : Select User Color 1 3 : Reserved
COLOR_2_ASSEMBLY_CNTL	5:4	0x0	0 : Select Color 2 1 : Select User Color 0 2 : Select User Color 1 3 : Reserved
COLOR_3_ASSEMBLY_CNTL	7:6	0x0	0 : Select Color 3 1 : Select User Color 0 2 : Select User Color 1 3 : Reserved
COLOR_4_ASSEMBLY_CNTL	9:8	0x0	0 : Select Color 4 1 : Select User Color 0 2 : Select User Color 1 3 : Reserved
COLOR_5_ASSEMBLY_CNTL	11:10	0x0	0 : Select Color 5 1 : Select User Color 0 2 : Select User Color 1 3 : Reserved
COLOR_6_ASSEMBLY_CNTL	13:12	0x0	0 : Select Color 6 1 : Select User Color 0 2 : Select User Color 1 3 : Reserved
COLOR_7_ASSEMBLY_CNTL	15:14	0x0	0 : Select Color 7 1 : Select User Color 0 2 : Select User Color 1 3 : Reserved
UPDATE_USER_COLOR_0_ENA	16	0x0	0 : User Color 0 State is NOT updated when User Color 0 is written. 1 : User Color 1 State IS updated when User Color 0 is written.
Reserved	18	0x0	Set to 0

VAP:VAP_VTX_ST_BLND_WT [0-3] · [R/W] · 32 bits · Access: 32 · MMReg:0x2430-0x243c

DESCRIPTION: *Data register*

Field Name	Bits	Default	Description
DATA_REGISTER	31:0	0x0	BLND_WT_0

VAP:VAP_VTX_ST_CLR [0-7]_A · [R/W] · 32 bits · Access: 32 · MMReg:0x232c-0x239c

DESCRIPTION: <i>Data register</i>			
Field Name	Bits	Default	Description
DATA_REGISTER	31:0	0x0	CLR_0_A

VAP:VAP_VTX_ST_CLR [0-7]_B · [R/W] · 32 bits · Access: 32 · MMReg:0x2328-0x2398			
DESCRIPTION: <i>Data register</i>			
Field Name	Bits	Default	Description
DATA_REGISTER	31:0	0x0	CLR_0_B

VAP:VAP_VTX_ST_CLR [0-7]_G · [R/W] · 32 bits · Access: 32 · MMReg:0x2324-0x2394			
DESCRIPTION: <i>Data register</i>			
Field Name	Bits	Default	Description
DATA_REGISTER	31:0	0x0	CLR_0_G

VAP:VAP_VTX_ST_CLR [0-7]_PKD · [W] · 32 bits · Access: 32 · MMReg:0x2470-0x248c			
DESCRIPTION: <i>Data register</i>			
Field Name	Bits	Default	Description
DATA_REGISTER	31:0	0x0	CLR_0_PKD

VAP:VAP_VTX_ST_CLR [0-7]_R · [R/W] · 32 bits · Access: 32 · MMReg:0x2320-0x2390			
DESCRIPTION: <i>Data register</i>			
Field Name	Bits	Default	Description
DATA_REGISTER	31:0	0x0	CLR_0_R

VAP:VAP_VTX_ST_DISC_FOG · [R/W] · 32 bits · Access: 32 · MMReg:0x2424			
DESCRIPTION: <i>Data register</i>			
Field Name	Bits	Default	Description
DATA_REGISTER	31:0	0x0	DISC_FOG

VAP:VAP_VTX_ST_EDGE_FLAGS · [R/W] · 32 bits · Access: 32 · MMReg:0x245c			
DESCRIPTION: <i>Data register</i>			
Field Name	Bits	Default	Description
DATA_REGISTER	0	0x0	EDGE_FLAGS

VAP:VAP_VTX_ST_END_OF_PKT · [W] · 32 bits · Access: 32 · MMReg:0x24ac			
--	--	--	--

DESCRIPTION: <i>Data register</i>			
Field Name	Bits	Default	Description
DATA_REGISTER	31:0	0x0	END_OF_PKT

VAP:VAP_VTX_ST_NORM_0_PKD · [W] · 32 bits · Access: 32 · MMReg:0x2498			
DESCRIPTION: <i>Data register</i>			
Field Name	Bits	Default	Description
DATA_REGISTER	31:0	0x0	NORM_0_PKD

VAP:VAP_VTX_ST_NORM_0_X · [R/W] · 32 bits · Access: 32 · MMReg:0x2310			
DESCRIPTION: <i>Data register</i>			
Field Name	Bits	Default	Description
DATA_REGISTER	31:0	0x0	NORM_0_X

VAP:VAP_VTX_ST_NORM_0_Y · [R/W] · 32 bits · Access: 32 · MMReg:0x2314			
DESCRIPTION: <i>Data register</i>			
Field Name	Bits	Default	Description
DATA_REGISTER	31:0	0x0	NORM_0_Y

VAP:VAP_VTX_ST_NORM_0_Z · [R/W] · 32 bits · Access: 32 · MMReg:0x2318			
DESCRIPTION: <i>Data register</i>			
Field Name	Bits	Default	Description
DATA_REGISTER	31:0	0x0	NORM_0_Z

VAP:VAP_VTX_ST_NORM_1_X · [R/W] · 32 bits · Access: 32 · MMReg:0x2450			
DESCRIPTION: <i>Data register</i>			
Field Name	Bits	Default	Description
DATA_REGISTER	31:0	0x0	NORM_1_X

VAP:VAP_VTX_ST_NORM_1_Y · [R/W] · 32 bits · Access: 32 · MMReg:0x2454			
DESCRIPTION: <i>Data register</i>			
Field Name	Bits	Default	Description
DATA_REGISTER	31:0	0x0	NORM_1_Y

VAP:VAP_VTX_ST_NORM_1_Z · [R/W] · 32 bits · Access: 32 · MMReg:0x2458			
--	--	--	--

DESCRIPTION: <i>Data register</i>			
Field Name	Bits	Default	Description
DATA_REGISTER	31:0	0x0	NORM_1_Z

VAP:VAP_VTX_ST_PNT_SPRT_SZ · [R/W] · 32 bits · Access: 32 · MMReg:0x2420			
DESCRIPTION: <i>Data register</i>			
Field Name	Bits	Default	Description
DATA_REGISTER	31:0	0x0	PNT_SPRT_SZ

VAP:VAP_VTX_ST_POS_0_W_4 · [R/W] · 32 bits · Access: 32 · MMReg:0x230c			
DESCRIPTION: <i>Data register</i>			
Field Name	Bits	Default	Description
DATA_REGISTER	31:0	0x0	POS_0_W

VAP:VAP_VTX_ST_POS_0_X_2 · [W] · 32 bits · Access: 32 · MMReg:0x2490			
DESCRIPTION: <i>Data register</i>			
Field Name	Bits	Default	Description
DATA_REGISTER	31:0	0x0	POS_0_X_2

VAP:VAP_VTX_ST_POS_0_X_3 · [W] · 32 bits · Access: 32 · MMReg:0x24a0			
DESCRIPTION: <i>Data register</i>			
Field Name	Bits	Default	Description
DATA_REGISTER	31:0	0x0	POS_0_X_3

VAP:VAP_VTX_ST_POS_0_X_4 · [R/W] · 32 bits · Access: 32 · MMReg:0x2300			
DESCRIPTION: <i>Data register</i>			
Field Name	Bits	Default	Description
DATA_REGISTER	31:0	0x0	POS_0_X

VAP:VAP_VTX_ST_POS_0_Y_2 · [W] · 32 bits · Access: 32 · MMReg:0x2494			
DESCRIPTION: <i>Data register</i>			
Field Name	Bits	Default	Description
DATA_REGISTER	31:0	0x0	POS_0_Y_2

VAP:VAP_VTX_ST_POS_0_Y_3 · [W] · 32 bits · Access: 32 · MMReg:0x24a4			
---	--	--	--

DESCRIPTION: <i>Data register</i>			
Field Name	Bits	Default	Description
DATA_REGISTER	31:0	0x0	POS_0_Y_3

VAP:VAP_VTX_ST_POS_0_Y_4 · [R/W] · 32 bits · Access: 32 · MMReg:0x2304			
DESCRIPTION: <i>Data register</i>			
Field Name	Bits	Default	Description
DATA_REGISTER	31:0	0x0	POS_0_Y

VAP:VAP_VTX_ST_POS_0_Z_3 · [W] · 32 bits · Access: 32 · MMReg:0x24a8			
DESCRIPTION: <i>Data register</i>			
Field Name	Bits	Default	Description
DATA_REGISTER	31:0	0x0	POS_0_Z_3

VAP:VAP_VTX_ST_POS_0_Z_4 · [R/W] · 32 bits · Access: 32 · MMReg:0x2308			
DESCRIPTION: <i>Data register</i>			
Field Name	Bits	Default	Description
DATA_REGISTER	31:0	0x0	POS_0_Z

VAP:VAP_VTX_ST_POS_1_W · [R/W] · 32 bits · Access: 32 · MMReg:0x244c			
DESCRIPTION: <i>Data register</i>			
Field Name	Bits	Default	Description
DATA_REGISTER	31:0	0x0	POS_1_W

VAP:VAP_VTX_ST_POS_1_X · [R/W] · 32 bits · Access: 32 · MMReg:0x2440			
DESCRIPTION: <i>Data register</i>			
Field Name	Bits	Default	Description
DATA_REGISTER	31:0	0x0	POS_1_X

VAP:VAP_VTX_ST_POS_1_Y · [R/W] · 32 bits · Access: 32 · MMReg:0x2444			
DESCRIPTION: <i>Data register</i>			
Field Name	Bits	Default	Description
DATA_REGISTER	31:0	0x0	POS_1_Y

VAP:VAP_VTX_ST_POS_1_Z · [R/W] · 32 bits · Access: 32 · MMReg:0x2448			
---	--	--	--

DESCRIPTION: <i>Data register</i>			
Field Name	Bits	Default	Description
DATA_REGISTER	31:0	0x0	POS_1_Z

VAP:VAP_VTX_ST_PVMS · [R/W] · 32 bits · Access: 32 · MMReg:0x231c			
DESCRIPTION: <i>Data register</i>			
Field Name	Bits	Default	Description
DATA_REGISTER	31:0	0x0	PVMS

VAP:VAP_VTX_ST_SHININESS_0 · [R/W] · 32 bits · Access: 32 · MMReg:0x2428			
DESCRIPTION: <i>Data register</i>			
Field Name	Bits	Default	Description
DATA_REGISTER	31:0	0x0	SHININESS_0

VAP:VAP_VTX_ST_SHININESS_1 · [R/W] · 32 bits · Access: 32 · MMReg:0x242c			
DESCRIPTION: <i>Data register</i>			
Field Name	Bits	Default	Description
DATA_REGISTER	31:0	0x0	SHININESS_1

VAP:VAP_VTX_ST_TEX [0-7]_Q · [R/W] · 32 bits · Access: 32 · MMReg:0x23ac-0x241c			
DESCRIPTION: <i>Data register</i>			
Field Name	Bits	Default	Description
DATA_REGISTER	31:0	0x0	TEX_0_Q

VAP:VAP_VTX_ST_TEX [0-7]_R · [R/W] · 32 bits · Access: 32 · MMReg:0x23a8-0x2418			
DESCRIPTION: <i>Data register</i>			
Field Name	Bits	Default	Description
DATA_REGISTER	31:0	0x0	TEX_0_R

VAP:VAP_VTX_ST_TEX [0-7]_S · [R/W] · 32 bits · Access: 32 · MMReg:0x23a0-0x2410			
DESCRIPTION: <i>Data register</i>			
Field Name	Bits	Default	Description
DATA_REGISTER	31:0	0x0	TEX_0_S

VAP:VAP_VTX_ST_TEX [0-7]_T · [R/W] · 32 bits · Access: 32 · MMReg:0x23a4-0x2414			
--	--	--	--

DESCRIPTION: <i>Data register</i>			
Field Name	Bits	Default	Description
DATA_REGISTER	31:0	0x0	TEX_0_T

VAP:VAP_VTX_ST_USR_CLR_A · [R/W] · 32 bits · Access: 32 · MMReg:0x246c			
DESCRIPTION: <i>Data register</i>			
Field Name	Bits	Default	Description
DATA_REGISTER	31:0	0x0	USR_CLR_A

VAP:VAP_VTX_ST_USR_CLR_B · [R/W] · 32 bits · Access: 32 · MMReg:0x2468			
DESCRIPTION: <i>Data register</i>			
Field Name	Bits	Default	Description
DATA_REGISTER	31:0	0x0	USR_CLR_B

VAP:VAP_VTX_ST_USR_CLR_G · [R/W] · 32 bits · Access: 32 · MMReg:0x2464			
DESCRIPTION: <i>Data register</i>			
Field Name	Bits	Default	Description
DATA_REGISTER	31:0	0x0	USR_CLR_G

VAP:VAP_VTX_ST_USR_CLR_PKD · [W] · 32 bits · Access: 32 · MMReg:0x249c			
DESCRIPTION: <i>Data register</i>			
Field Name	Bits	Default	Description
DATA_REGISTER	31:0	0x0	USR_CLR_PKD

VAP:VAP_VTX_ST_USR_CLR_R · [R/W] · 32 bits · Access: 32 · MMReg:0x2460			
DESCRIPTION: <i>Data register</i>			
Field Name	Bits	Default	Description
DATA_REGISTER	31:0	0x0	USR_CLR_R

10.11 Z Buffer Registers

ZB:ZB_BW_CNTL · [R/W] · 32 bits · Access: 8/16/32 · MMReg:0x4f1c			
DESCRIPTION: Z Buffer Band-Width Control			
Field Name	Bits	Default	Description
HIZ_ENABLE	0	0x0	Enables hierarchical Z. <u>POSSIBLE VALUES:</u> 00 - Hierarchical Z Disabled 01 - Hierarchical Z Enabled
HIZ_MIN	1	0x0	<u>POSSIBLE VALUES:</u> 00 - Update Hierarchical Z with Max value 01 - Update Hierarchical Z with Min value
FAST_FILL	2	0x0	<u>POSSIBLE VALUES:</u> 00 - Fast Fill Disabled 01 - Fast Fill Enabled (ZB_DEPTHCLEARVALUE)
RD_COMP_ENABLE	3	0x0	Enables reading of compressed Z data from memory to the cache. <u>POSSIBLE VALUES:</u> 00 - Z Read Compression Disabled 01 - Z Read Compression Enabled
WR_COMP_ENABLE	4	0x0	Enables writing of compressed Z data from cache to memory, <u>POSSIBLE VALUES:</u> 00 - Z Write Compression Disabled 01 - Z Write Compression Enabled
ZB_CB_CLEAR	5	0x0	This bit is set when the Z buffer is used to help the CB in clearing a region. Part of the region is cleared by the color buffer and part will be cleared by the Z buffer. Since the Z buffer does not have any write masks in the cache, full micro-tiles need to be written. If a partial micro-tile is touched, then the un-touched part will be unknowns. The cache will operate in write-allocate mode and quads will be accumulated in the cache and then evicted to main memory. The color value is supplied through the ZB_DEPTHCLEARVALUE register. <u>POSSIBLE VALUES:</u> 00 - Z unit cache controller does RMW 01 - Z unit cache controller does cache-line granular Write only
FORCE_COMPRESSED_STENCIL_VALUE	6	0x0	Enabling this bit will force all the compressed stencil values to be equal to old_stencil_value & ~ZB_STENCILREFMASK.stencilwrite mask ZB_STENCILREFMASK.stencilref & ZB_STENCILREFMA

			<p>SK.stencilwritemask. This should be enabled during stencil clears to avoid needless decompression.</p> <p><u>POSSIBLE VALUES:</u> 00 - Do not force the compressed stencil value. 01 - Force the compressed stencil value.</p>
ZEQUAL_OPTIMIZE_DISABLE	7	0x0	<p>By default this is 0 (enabled). When NEWZ=OLDZ, then writes do not occur to save BW.</p> <p><u>POSSIBLE VALUES:</u> 00 - Enable not updating the Z buffer if NewZ=OldZ 01 - Disable above feature (in case there is a bug)</p>
SEQUAL_OPTIMIZE_DISABLE	8	0x0	<p>By default this is 0 (enabled). When NEW_STENCIL=OLD_STENCIL, then writes do not occur to save BW.</p> <p><u>POSSIBLE VALUES:</u> 00 - Enable not updating the Stencil buffer if NewS=OldS 01 - Disable above feature (in case there is a bug)</p>
BMASK_DISABLE	10	0x0	<p>Controls whether bytemasking is used or not.</p> <p><u>POSSIBLE VALUES:</u> 00 - Enable bytemasking 01 - Disable bytemasking</p>
HIZ_EQUAL_REJECT_ENABLE	11	0x0	<p>Enables hiz rejects when the z function is equals.</p> <p><u>POSSIBLE VALUES:</u> 00 - Disable 01 - Enable</p>
HIZ_FP_EXP_BITS	14: 12	0x0	<p>Number of exponent bits to use for the hiz floating point format. Values 0 to 5 are legal. 0 will disable the floating point hiz encoding.</p>
HIZ_FP_INVERT	15	0x0	<p>Determines whether leading zeros or ones are eliminated.</p> <p><u>POSSIBLE VALUES:</u> 00 - Count leading 1s 01 - Count leading 0s</p>
TILE_OVERWRITE_RECOMPRESSI ON_DISABLE	16	0x0	<p>The zb tries to detect single plane equations that completely overwrite a compressed tile. This allows the tile to jump from the decompressed state to the fully compressed state.</p> <p><u>POSSIBLE VALUES:</u> 00 - Enable tile overwrite recompression 01 - Disable tile overwrite recompression</p>
CONTIGUOUS_6XAA_SAMPLES_DI SABLE	17	0x0	<p>This disables storing samples contiguously in 6xaa.</p> <p><u>POSSIBLE VALUES:</u> 00 - Enable contiguous samples 01 - Disable contiguous samples</p>

PEQ_PACKING_ENABLE	18	0x0	Enables packing of the plane equations to eliminate wasted peq slots. <u>POSSIBLE VALUES:</u> 00 - Disable 01 - Enable
COVERED_PTR_MASKING_ENABLE	19	0x0	Enables discarding of pointers from pixels that are going to be covered. This reduces the apparent number of plane equations in use. <u>POSSIBLE VALUES:</u> 00 - Disable 01 - Enable

ZB:ZB_CNTL · [R/W] · 32 bits · Access: 8/16/32 · MMRReg:0x4f00			
DESCRIPTION: Z Buffer Control			
Field Name	Bits	Default	Description
STENCIL_ENABLE	0	0x0	Enables stenciling. <u>POSSIBLE VALUES:</u> 00 - Disabled 01 - Enabled
Z_ENABLE	1	0x0	Enables Z functions. <u>POSSIBLE VALUES:</u> 00 - Disabled 01 - Enabled
ZWRITEENABLE	2	0x0	Enables writing of the Z buffer. <u>POSSIBLE VALUES:</u> 00 - Disable 01 - Enable
ZSIGNED_COMPARE	3	0x0	Enable signed Z buffer comparison , for W-buffering. <u>POSSIBLE VALUES:</u> 00 - Disable 01 - Enable
STENCIL_FRONT_BACK	4	0x0	When STENCIL_ENABLE is set, setting STENCIL_FRONT_BACK bit to one specifies that stencilfunc/stencilfail/stencilzpass/stencilzfail registers are used if the quad is generated from front faced primitive and stencilfunc_bf/stencilfail_bf/stencilzpass_bf/stencilzfail_bf are used if the quad is generated from a back faced primitive. If the STENCIL_FRONT_BACK is not set, then stencilfunc/stencilfail/stencilzpass/stencilzfail registers determine the operation independent of the front/back face state of the quad.

			<u>POSSIBLE VALUES:</u> 00 - Disable 01 - Enable
ZSIGNED_MAGNITUDE	5	0x0	Specifies the signed number type to use for the Z buffer comparison. This only has an effect when ZSIGNED_COMPARE is enabled. <u>POSSIBLE VALUES:</u> 00 - Twos complement 01 - Signed magnitude
STENCIL_REFMASK_FRONT_BACK	6	0x0	<u>POSSIBLE VALUES:</u> 00 - Disable 01 - Enable

ZB:ZB_DEPTHCLEARVALUE · [R/W] · 32 bits · Access: 8/16/32 · MMReg:0x4f28			
DESCRIPTION: <i>Z Buffer Clear Value</i>			
Field Name	Bits	Default	Description
DEPTHCLEARVALUE	31:0	0x0	When a block has a Z Mask value of 0, all Z values in that block are cleared to this value. In 24bpp, the stencil value is also updated regardless of whether it is enabled or not.

ZB:ZB_DEPTHOFFSET · [R/W] · 32 bits · Access: 8/16/32 · MMReg:0x4f20			
DESCRIPTION: <i>Z Buffer Address Offset</i>			
Field Name	Bits	Default	Description
DEPTHOFFSET	31:5	0x0	2K aligned Z buffer address offset for macro tiles.

ZB:ZB_DEPTHPITCH · [R/W] · 32 bits · Access: 8/16/32 · MMReg:0x4f24			
DESCRIPTION: <i>Z Buffer Pitch and Endian Control</i>			
Field Name	Bits	Default	Description
DEPTHPITCH	13:2	0x0	Z buffer pitch in multiples of 4 pixels.
DEPTHMACROTILE	16	0x0	Specifies whether Z buffer is macro-tiled. macro-tiles are 2K aligned <u>POSSIBLE VALUES:</u> 00 - macro tiling disabled 01 - macro tiling enabled
DEPTHMICROTILE	18:17	0x0	Specifies whether Z buffer is micro-tiled. micro-tiles is 32 bytes <u>POSSIBLE VALUES:</u> 00 - 32 byte cache line is linear

			01 - 32 byte cache line is tiled 02 - 32 byte cache line is tiled square (only applies to 16-bit pixels) 03 - Reserved
DEPTHENDIAN	20:19	0x0	Specifies endian control for the Z buffer. <u>POSSIBLE VALUES:</u> 00 - No swap 01 - Word swap 02 - Dword swap 03 - Half Dword swap

ZB:ZB_DEPTHXY_OFFSET · [R/W] · 32 bits · Access: 8/16/32 · MMReg:0x4f60			
DESCRIPTION: <i>Depth buffer X and Y coordinate offset</i>			
Field Name	Bits	Default	Description
DEPTHX_OFFSET	11:1	0x0	X coordinate offset. multiple of 32 . Bits 4:0 have to be zero
DEPTHY_OFFSET	27:17	0x0	Y coordinate offset. multiple of 32 . Bits 4:0 have to be zero

ZB:ZB_FIFO_SIZE · [R/W] · 32 bits · Access: 8/16/32 · MMReg:0x4fd0			
DESCRIPTION: <i>Sets the fifo sizes</i>			
Field Name	Bits	Default	Description
OP_FIFO_SIZE	1:0	0x0	Determines the size of the op fifo <u>POSSIBLE VALUES:</u> 00 - Full size 01 - 1/2 size 02 - 1/4 size 03 - 1/8 size

ZB:ZB_FORMAT · [R/W] · 32 bits · Access: 8/16/32 · MMReg:0x4f10			
DESCRIPTION: <i>Format of the Data in the Z buffer</i>			
Field Name	Bits	Default	Description
DEPTHFORMAT	3:0	0x0	Specifies the format of the Z buffer. <u>POSSIBLE VALUES:</u> 00 - 16-bit Integer Z 01 - 16-bit compressed 13E3 02 - 24-bit Integer Z, 8 bit Stencil (LSBs) 03 - RESERVED 04 - RESERVED 05 - RESERVED 06 - RESERVED

			07 - RESERVED 08 - RESERVED 09 - RESERVED 10 - RESERVED 11 - RESERVED 12 - RESERVED 13 - RESERVED 14 - RESERVED 15 - RESERVED
INVERT	4	0x0	POSSIBLE VALUES: 00 - in 13E3 format , count leading 1`s 01 - in 13E3 format , count leading 0`s.
PEQ8	5	0x0	This bit is unused

ZB:ZB_HIZ_DWORD · [R/W] · 32 bits · Access: 8/16/32 · MMRReg:0x4f4c			
DESCRIPTION: <i>Hierarchical Z Data</i>			
Field Name	Bits	Default	Description
HIZ_DWORD	31:0	0x0	This DWORD contains 8-bit values for 4 blocks.. Reading this register causes a read from the address pointed to by RDINDEX. Writing to this register causes a write to the address pointed to by WRINDEX.

ZB:ZB_HIZ_OFFSET · [R/W] · 32 bits · Access: 8/16/32 · MMRReg:0x4f44			
DESCRIPTION: <i>Hierarchical Z Memory Offset</i>			
Field Name	Bits	Default	Description
HIZ_OFFSET	17:2	0x0	DWORD offset into HiZ RAM.

ZB:ZB_HIZ_PITCH · [R/W] · 32 bits · Access: 8/16/32 · MMRReg:0x4f54			
DESCRIPTION: <i>Hierarchical Z Pitch</i>			
Field Name	Bits	Default	Description
HIZ_PITCH	13:4	0x0	Pitch used in HiZ address computation.

ZB:ZB_HIZ_RDINDEX · [R/W] · 32 bits · Access: 8/16/32 · MMRReg:0x4f50			
DESCRIPTION: <i>Hierarchical Z Read Index</i>			
Field Name	Bits	Default	Description
HIZ_RDINDEX	17:2	0x0	Read index into HiZ RAM.

ZB:ZB_HIZ_WRINDEX · [R/W] · 32 bits · Access: 8/16/32 · MMRReg:0x4f48			
DESCRIPTION: <i>Hierarchical Z Write Index</i>			
Field Name	Bits	Default	Description

HIZ_WRINDEX	17:2	0x0	Self-incrementing write index into the HiZ RAM. Starting write index must start on a DWORD boundary. Each time ZB_HIZ_DWORD is written, this index will autoincrement. HIZ_OFFSET and HIZ_PITCH are not used to compute read/write address to HIZ ram, when it is accessed through WRINDEX and DWORD
-------------	------	-----	--

ZB:ZB_STENCILREFMASK · [R/W] · 32 bits · Access: 8/16/32 · MMRReg:0x4f08			
DESCRIPTION: <i>Stencil Reference Value and Mask</i>			
Field Name	Bits	Default	Description
STENCILREF	7:0	0x0	Specifies the reference stencil value.
STENCILMASK	15:8	0x0	This value is ANDed with both the reference and the current stencil value prior to the stencil test.
STENCILWRITEMASK	23:16	0x0	Specifies the write mask for the stencil planes.

ZB:ZB_STENCILREFMASK_BF · [R/W] · 32 bits · Access: 8/16/32 · MMRReg:0x4fd4			
DESCRIPTION: <i>Stencil Reference Value and Mask for backfacing quads</i>			
Field Name	Bits	Default	Description
STENCILREF	7:0	0x0	Specifies the reference stencil value.
STENCILMASK	15:8	0x0	This value is ANDed with both the reference and the current stencil value prior to the stencil test.
STENCILWRITEMASK	23:16	0x0	Specifies the write mask for the stencil planes.

ZB:ZB_ZCACHE_CTLSTAT · [R/W] · 32 bits · Access: 8/16/32 · MMRReg:0x4f18			
DESCRIPTION: <i>Z Buffer Cache Control/Status</i>			
Field Name	Bits	Default	Description
ZC_FLUSH	0	0x0	Setting this bit flushes the dirty data from the Z cache. Unless ZC_FREE bit is also set, the tags in the cache remain valid. A purge is achieved by setting both ZC_FLUSH and ZC_FREE. This is a sticky bit and it clears itself at the end of the operation. <u>POSSIBLE VALUES:</u> 00 - No effect 01 - Flush and Free Z cache lines
ZC_FREE	1	0x0	Setting this bit invalidates the Z cache tags. Unless ZC_FLUSH bit is also set, the cachelines are not written to memory. A purge is achieved by setting both ZC_FLUSH and ZC_FREE. This is a sticky bit that clears itself at the end of the operation. <u>POSSIBLE VALUES:</u> 00 - No effect

			01 - Free Z cache lines (invalidate)
ZC_BUSY	31	0x0	This bit is unused ... <u>POSSIBLE VALUES:</u> 00 - Idle 01 - Busy

ZB:ZB_ZPASS_ADDR · [R/W] · 32 bits · Access: 8/16/32 · MMReg:0x4f5c			
DESCRIPTION: <i>Z Buffer Z Pass Counter Address</i>			
Field Name	Bits	Default	Description
ZPASS_ADDR	31:2	0x0	Writing this location with a DWORD address causes the value in ZB_ZPASS_DATA to be written to main memory at the location pointed to by this address. NOTE: R300 has 2 pixel pipes. Broadcasting this address causes both pipes to write their ZPASS value to the same address. There is no guarantee which pipe will write last. So when writing to this register, the GA needs to be programmed to send the write command to pipe 0. Then a different address needs to be written to pipe 1. Then both pipes should be enabled for further register writes.

ZB:ZB_ZPASS_DATA · [R/W] · 32 bits · Access: 8/16/32 · MMReg:0x4f58			
DESCRIPTION: <i>Z Buffer Z Pass Counter Data</i>			
Field Name	Bits	Default	Description
ZPASS_DATA	31:0	0x0	Contains the number of Z passed pixels since the last write to this location. Writing this location resets the count to the value written.

ZB:ZB_ZSTENCILCNTL · [R/W] · 32 bits · Access: 8/16/32 · MMReg:0x4f04			
DESCRIPTION: <i>Z and Stencil Function Control</i>			
Field Name	Bits	Default	Description
ZFUNC	2:0	0x0	Specifies the Z function. <u>POSSIBLE VALUES:</u> 00 - Never 01 - Less 02 - Less or Equal 03 - Equal 04 - Greater or Equal 05 - Greater Than 06 - Not Equal 07 - Always
STENCILFUNC	5:3	0x0	Specifies the stencil function.

			<p><u>POSSIBLE VALUES:</u></p> <ul style="list-style-type: none"> 00 - Never 01 - Less 02 - Less or Equal 03 - Equal 04 - Greater or Equal 05 - Greater 06 - Not Equal 07 - Always
STENCILFAIL	8:6	0x0	<p>Specifies the stencil value to be written if the stencil test fails.</p> <p><u>POSSIBLE VALUES:</u></p> <ul style="list-style-type: none"> 00 - Keep: New value = Old value 01 - Zero: New value = 0 02 - Replace: New value = STENCILREF 03 - Increment: New value++ (clamp) 04 - Decrement: New value-- (clamp) 05 - Invert new value: New value = !Old value 06 - Increment: New value++ (wrap) 07 - Decrement: New value-- (wrap)
STENCILZPASS	11:9	0x0	<p>Same encoding as STENCILFAIL. Specifies the stencil value to be written if the stencil test passes and the Z test passes (or is not enabled).</p>
STENCILZFAIL	14:12	0x0	<p>Same encoding as STENCILFAIL. Specifies the stencil value to be written if the stencil test passes and the Z test fails.</p>
STENCILFUNC_BF	17:15	0x0	<p>Same encoding as STENCILFUNC. Specifies the stencil function for back faced quads , if STENCIL_FRONT_BACK = 1.</p>
STENCILFAIL_BF	20:18	0x0	<p>Same encoding as STENCILFAIL. Specifies the stencil value to be written if the stencil test fails for back faced quads, if STENCIL_FRONT_BACK = 1</p>
STENCILZPASS_BF	23:21	0x0	<p>Same encoding as STENCILFAIL. Specifies the stencil value to be written if the stencil test passes and the Z test passes (or is not enabled) for back faced quads, if STENCIL_FRONT_BACK = 1</p>
STENCILZFAIL_BF	26:24	0x0	<p>Same encoding as STENCILFAIL. Specifies the stencil value to be written if the stencil test passes and the Z test fails for back faced quads, if STENCIL_FRONT_BACK = 1</p>
ZERO_OUTPUT_MASK	27	0x0	<p>Zeroes the zb coverage mask output. This does not affect the updating of the depth or stencil values.</p> <p><u>POSSIBLE VALUES:</u></p> <ul style="list-style-type: none"> 00 - Disable 01 - Enable

ZB:ZB_ZTOP · [R/W] · 32 bits · Access: 8/16/32 · MMReg:0x4f14			
Field Name	Bits	Default	Description
ZTOP	0	0x0	POSSIBLE VALUES: 00 - Z is at the bottom of the pipe, after the fog unit. 01 - Z is at the top of the pipe, after the scan unit.